



Engineering
& Design

Storm Water Pollution Prevention Plan (SWPPP)

December 2021

Revised January 2023

Revised June 2024

Revised January 2025

Dewpoint North
Town of Wawayanda
SBL: 4-1-50.2
Orange County, New York

Prepared for:

Dewpoint North LLC
21 Philips Pkwy
Montvale, NJ 07645

Prepared by:

Cory D. Robinson, P.E.
New York Professional
Licensed Professional Engineer
License No. 103788

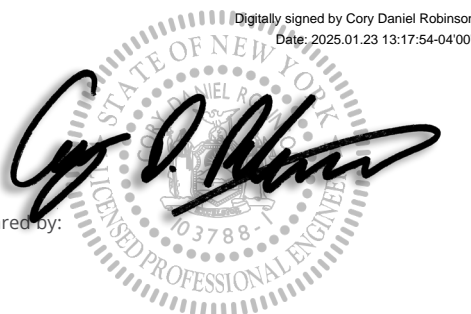

Colliers Engineering & Design
555 Hudson Valley Avenue Suite 101
New Windsor, New York 12553
Main: 845.564.4495
Colliersengineering.com

Project No. 20006912A

Table of Contents

<i>List of Appendices</i>	0
I. EXECUTIVE SUMMARY	1
<i>Figure 1: Project Location</i>	1
<i>(Source: Google Earth)</i>	1
II. INTRODUCTION	2
III. STORMWATER MANAGEMENT GOALS	2
IV. METHODOLOGY	4
V. DISCUSSION	5
<i>Discussion of Design Points</i>	5
<i>TABLE 1: WATERSHED CHARACTERISTICS</i>	5
4.3.3 GEOTECHNICAL TESTING	6
ZERO-NET INCREASE:	6
<i>TABLE 2: Existing and Proposed Peak Flow Summary to the Design Point</i>	6
HOTSPOT RUNOFF	7
WATER QUALITY VOLUME (WQV):	7
<i>TABLE 3: REQUIRED WATER QUALITY CALCULATION</i>	8
RUNOFF REDUCTION VOLUME	8
<i>TABLE 4 –RRv Volumes Provided</i>	9
RUNOFF REDUCTION VOLUME (RRV) THROUGH SITE PLANNING:	9
<i>TABLE 5: GREEN INFRASTRUCTURE SITE PLANNING</i>	10
GREEN INFRASTRUCTURE TECHNIQUES (GITS):	11
<i>TABLE 6: GREEN INFRASTRUCTURE FEASIBILITY</i>	11
BIORETENTION BASINS WITH UNDERDRAIN (NO INFILTRATION):	13
<i>Hydrodynamic Separator (Swirl Chamber):</i>	15
<i>Table 7: Swirl Chamber Sizing Calculations</i>	16

VI. *EROSION & SEDIMENT CONTROL* 17

303(d) Segments Impaired by Construction related pollutants..... 17

Construction Sequencing:..... 20

VII. *GOOD HOUSEKEEPING* 22

VIII. *RESPONSIBLE PARTIES* 24

IX. *END OF PROJECT – TERMINATION OF PERMIT*..... 25

X. *SUMMARY OF PROPOSED STORMWATER IMPROVEMENTS*..... 26

XI. *CONCLUSION* 26

List of Appendices

Appendix 1	Watershed Maps
Appendix 2a	HydroCAD Data (Existing Conditions)
Appendix 2b	HydroCAD Data (Proposed Conditions)
Appendix 3	NYSDEC Green Infrastructure Worksheets
Appendix 4	SPDES GP-0-25-001
Appendix 5	Draft Notice of Intent (N.O.I.)
Appendix 6	Draft Notice of Termination (N.O.T.)
Appendix 7	Draft MS4 Acceptance Form
Appendix 8	NRCS Hydrologic Soil Mapping
Appendix 9	Construction Site Log Book (Bluebook Appendix H)
Appendix 10	NYSDEC Construction Stormwater Inspection Manual
Appendix 11	Blank Contractor Certification Form
Appendix 12	NYSDEC Deep-Ripping & Decompaction Manual
Appendix 13	NRCC Precipitation Tables
Appendix 14	Operation and Maintenance Plan
Appendix 15	Geotechnical Investigation Report by Kevin L. Patton, P.E.
Appendix 16	Hydro International First Defense Swirl Chamber Information
Appendix 17	Erosion and Sediment Control Plan and Details

I. EXECUTIVE SUMMARY

Project Name:	Operator Name and Address:
Dewpoint North Town of Wawayanda Orange County, NY	Dewpoint North, LLC 21 Philips Pkwy Montvale, NJ 07645
Project Engineer and Firm:	Contractor Name and Address:
Cory D. Robinson, P.E. Colliers Engineering & Design CT, P.C. 555 Hudson Valley Avenue, Suite 101 New Windsor, NY 12553 (845) 564-4495	TBD
Project Location:	MS4 Contact:
Dolsontown Road (opposite Caskey Ln) SBL: 4-1-50.2 Town of Wawayanda, Orange County, NY	Town of Wawayanda (NYR20A279) 80 Ridgebury Hill Road Slate Hill, NY 10973



Figure 1: Project Location

(Source: Google Earth)

II. INTRODUCTION

The existing parcel is approximately 6.17 acres in size and has frontage along Dolsontown Road to the south. The parcel is currently undeveloped with a mixture of woodlands and wetlands. A portion of the site contains wetland under the jurisdiction of the US Army Corps of Engineers (ACOE). The Monhagen Brook travels through the northwest corner of the site, which is a waterbody listed in Appendix E of the GP-0-25-001. The project site is located within the Town of Wawayanda MC-1 (Mixed Commercial) zoning district.

The proposed project consists of the construction of a 32,000 square foot warehouse/distribution facility along with associated site stormwater & utility improvements. Other associated site improvements include 33 vehicle parking spaces & 6 loading docks. The lot has a proposed driveway entrance on Dolsontown Road suitable for vehicular and truck access to the facility. A roadway dedication is also proposed as part of this project which will be a portion of the current parcel to the Dolsontown Road Right-of-Way (ROW) and create a minimum 66' wide ROW across the frontage.

Stormwater runoff currently sheet flows from southeast to northwest across the site towards the wetland and Monhagen Brook, which flows from north to south across the site. The proposed condition will convey stormwater via sheet flow across the parking lots, into inlets and pipes, and into a variety of Green Infrastructure techniques, including bioretention ponds, where the runoff will be treated for Water Quality (WQ) and Runoff Reduction (RRv) before the excess runoff is discharged towards the design point of the Monhagen Brook. Stormwater 'Hotspot' runoff from truck loading bays and trailer storage/parking areas has been pretreated using oil-water separating swirl chambers prior to any infiltration where applicable. Stormwater facilities on site have been designed in accordance with the 2015 New York State Stormwater Management Design Manual and local requirements.

The site has been analyzed as new development and stormwater practices sized to manage the increase in impervious area. The study area was generally limited to the project site, utilizing the Monhagen Brook as the design point. The proposed improvements will result in the addition of approximately 1.93 acres of impervious area.

Due to the size of the project, coverage under the State Pollutant Discharge Elimination System Permit (SPDES GP 0-20-001) administered by New York State Department of Environmental Conservation (NYSDEC) is required.

III. STORMWATER MANAGEMENT GOALS

GOALS

This Stormwater Pollution Prevention Plan (SWPPP) has been prepared in compliance with the New York State Department of Environmental Conservation (NYSDEC) State Pollutant Discharge Elimination System (SPDES) General Permit for Stormwater Discharges from Construction Activity, Permit No. GP-0-25-001 (See Appendix 4). The SWPPP is a plan for controlling runoff and pollutants from a site during and after construction activities. The principle objective of this document is to

comply with the SPDES Permit for construction activities by planning and implementing the following practices:

- Reduction or elimination of erosion and sediment loading to water bodies during and after construction.
- Control of the impact of stormwater runoff on the water quality of the receiving waters.
- Control of the peak rate of runoff during and after construction.
- Maintenance of stormwater controls during and after completion of construction.
- Minimize impacts to the Monhagen Brook, which is on the NYSDEC's 303(d) list as an impaired water.

CLASSIFICATION & STANDARDS

The activities associated with this project are eligible for coverage under this permit. Using the General Permit guidelines for coverage, a summary of classification and requirements is provided below:

Project Type:

- Commercial development and redevelopment.
- Parking lot construction and reconstruction.
- All other construction activities that include the construction or reconstruction of impervious area or alter the hydrology from pre to post development conditions and are not listed in Table 1 of GP-0-25-001.

Classification: GP-0-25-001 Appendix B, Table 2 - "Construction activities that require the preparation of a SWPPP that includes Post Construction Stormwater Practices".

This project is located within the Town of Wawayanda regulated, traditional land use control Municipal Separate Stormwater Sewer System (MS4). The following guidance documents, in addition to various resources located on the NYS Department of Environmental Conservation website, were used in preparation of this SWPPP.

The New York State Stormwater Management Design Manual, by New York State Department of Environmental Conservation, August 2015 (NYSSMDM).

New York Standard Specifications for Erosion and Sediment Control, by New York State Department of Environmental Conservation, November 2016 ("Blue Book").

The SWPPP is intended to be a *'living'* document and should be revised and updated whenever site conditions dictate. Any proposed modifications shall be reviewed by the owner/operator prior to incorporation in the SWPPP and implementation at the project site. The certifying engineer of this SWPPP document shall be notified of any proposed modifications to this document. Any proposed modifications shall be in accordance with the NYSDEC technical standards.

IV. METHODOLOGY

1. The watersheds are divided into subareas, by topography, soils, and land use. A summary of the watershed areas, composite curve numbers, and travel times are shown in Table 1 below.
2. Rainfall depths used for this analysis are those published by the Northeast Regional Climate Center for the project location for the 100, 10, and 1-year frequency storms as directed in the NYSSMDM.
3. Boundary & Topographical mapping is taken from a survey titled "Outbound & Topographic Survey Plan Prepared for Dolsontown Road Section 4 Block 1 Lot 50.2" prepared by John W. McCord, Sr. PLS (License #050904) revised 06/17/2021.
4. The required water quality volume (WQv) was calculated in accordance with the Section 4.2 of the NYSSMDM. This is also the required RRv as per Section 4.3 of the NYSSMDM.
5. The provided RRv was calculated through the use of the Green Infrastructure (GI) Worksheets, Version 1.6, provided by NYSDEC. The GI worksheets are included in Appendix 3.
6. The peak flows from the watersheds in the existing condition are computed using the runoff curve numbers taken from TR-55 to determine undeveloped peak runoff and runoff hydrographs at the design points. The existing condition peak flows are presented in the report.
7. In the post-development condition, the peak flows from the proposed development are computed using the runoff curve numbers taken from TR-55. The watersheds are adjusted for the proposed improvements and grading of the site. The runoff flows are hydraulically routed for updated travel times, diversions, and new storage structures, as necessary. The resulting proposed peak flows at the design point are presented in the report.
8. A full Erosion & Sediment Control Plan (plans, details and construction sequencing) was designed in accordance with the New York State Standards and Specifications for Erosion and Sediment Control (aka the "bluebook") and has been included as an appendix of this report.
9. A long-term Operation & Maintenance Plan was developed for the proposed post-construction stormwater control practices and is included as an appendix of this report.
10. Maps indicating the various drainage conditions are enclosed in the appendices of this report. Schematic diagrams of the flow models in the existing and proposed conditions are included in the HydroCAD output within the Appendix.
11. A draft MS4 SWPPP Acceptance form, Notice of Termination (NOT), and Notice of Intent (NOI) have been included in the Appendix of this report to be executed as part of the SPDES permit. The MS4 form is to be completed by the municipality at the time of SWPPP acceptance and replaced in this report with the executed version. The NOI shall be filed electronically with the NYSDEC at the time of permit activation and replaced in this report with the executed version. The NOT is to be completed and filed with the municipality and NYSDEC at the time of permit closure.

V. DISCUSSION

Discussion of Design Points

The Project has one design point, the Monhagen Brook near the northwest corner of the site. The drainage areas were limited, wherever possible to the area of proposed development.

The design points evaluated in this report is described as follows:

Design Point 1 is the Monhagen Brook near the northwest corner of the site. The site runoff generally sheets from southeast to northwest across the site, from the site's frontage Dolsontown Road towards the ACOE wetland and the Monhagen Brook.

The Design Point location, the pre- and post-development land use, travel times flow paths, and watersheds are clearly identified on the watershed maps found in the Appendix of this report. The pre-development (hereafter "existing") and post-development (hereafter "proposed") watershed characteristics can be found in Table 1 below.

TABLE 1: WATERSHED CHARACTERISTICS

Existing Conditions			
	Area (acres)	CN	Tc (minutes)
EW1	5.15	76	16.4
Totals	5.15	76	-
Proposed Conditions			
	Area (acres)	CN	Tc
PW1A	2.60	78	16.4
PW1B1	0.59	92	6.0
PW1B2	0.37	98	6.0
PW1C	0.35	90	6.0
PW1D	0.93	94	6.0
PW1E	0.21	90	6.0
PW1F	0.10	93	6.0
Totals	5.15	86	-

The minimum Tc of 6 minutes, or 0.10 hours, is shown above for the catchment areas where the composite travel time did not meet this minimum. Watersheds with a Tc greater than the minimum have been identified with the travel path on the watershed maps in the Appendix.

SOIL TYPES

Soil data for this project was obtained from the USDA Natural Resources Conservation Service Web Soil Survey (NRCS WSS). A copy of the report generated for the site can be found in the Appendix of this report.

Several different soil designations are identified throughout the entire project. A further detailed description of the soil characteristics and properties can be found in the NRCS WSS included as an Appendix to this report.

HYDROLOGIC SOIL GROUP (HSG)

Hydrologic soil groups are based on estimates of runoff potential. Soils are assigned to one of four groups according to the rate of water infiltration when the soils are not protected by vegetation, are thoroughly wet, and receive precipitation from long duration storms. The soils in the United States are assigned to four groups (A, B, C, and D) and three dual classes (A/D, B/D, and C/D). Dual class soil groups are conservatively considered “D” soils.

All the soils existing on site have been identified through the NRCS WSS as HSG ‘D’ Soils.

4.3.3 GEOTECHNICAL TESTING

Project specific geotechnical testing has been performed by others and the geotechnical report has been included as an appendix to this report.

ZERO-NET INCREASE:

The proposed storm water improvements for the site provide the required channel protection (CPv), overbank flood protection (Qp), and extreme flood protection (Qf). Peak flows have been reduced at the selected design point in the proposed condition for the 100, 10, and 1-year storms. These peak flow reductions can also be found in Table 2 below.

As is evident in the table below, attenuation of the peak flows by reduction of impervious areas in the redeveloped areas, utilization of SMP’s with RRv capacity, and site planning, have effectively reduced the peak discharge while providing the required runoff reduction, which will be further discussed below.

TABLE 2: Existing and Proposed Peak Flow Summary to the Design Point

<u>Design Point</u>	<u>Storm Events (yr)</u>	<u>Existing (cfs)</u>	<u>Proposed (cfs)</u>	<u>Diff. (cfs)</u>	<u>Percent</u>
DP1	1	3.15	2.14	-1.01	-32%
	10	9.91	8.54	-1.37	-14%
	100	23.46	21.58	-1.88	-8%

HOTSPOT RUNOFF

As defined in section 4.11 of the NYSSWDM, stormwater “hotspots” are land uses and activities that generate higher concentration of hydrocarbons, trace metals or toxicants that are found in typical stormwater runoff. The loading docks and trailer storage/parking areas would fall under the definition of a hotspot.

To meet the design criteria for hot spot runoff, pretreatment is provided using swirl chambers designed to separate floatable and contaminants, and runoff has not been allowed to infiltrate prior to treatment. In addition, the bioretention area north of the loading dock which receives hotspot runoff includes an impermeable liner to further satisfy this requirement.

WATER QUALITY VOLUME (WQV):

The Water Quality Volume (WQv) requirement is designed to improve water quality. The WQv is directly related to the impervious cover created at a site. The design captures and treats 90% of the average annual stormwater runoff volume. The 90% rainfall event value (P) used in the calculations (1.4”) is shown below in the portion of Figure 4.1 from Section 4.2, page 4-3 in the NYSSMDM (depicted below).

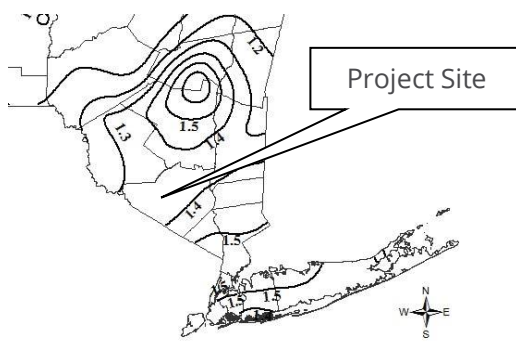

90% Rule:

$$WQ_v = [(P)(R_v)(A)] / 12$$

$$R_v = 0.05 + 0.009(I)$$

I = Impervious Cover (Percent)
 Minimum R_v = 0.2
 P = 90% Rainfall Event Number (See Figure 4.1)
 A = site area in acres

Using the total impervious area for the project site, both in the existing and proposed condition. The Runoff Coefficient “R_v” in the computation of Water Quality Volume WQ_v is dependent on the percent impervious cover. As per Section 4.2 of the NYSSMDM, 100% of the water quality volume shall be treated.

TABLE 3: REQUIRED WATER QUALITY CALCULATION

Catchment (GI Worksheet numbering)	Description (HydroCAD designation)	90% Rainfall Event Number (P) Inches	Total Area (acres)	Impervious Area (acres)	Percent Impervious (I) %	Runoff Coefficient Rv	Required WQv (cf)	Provided WQv (cf)
1	PW1B1	1.4	0.59	0.40	68%	0.66	1,979	1,979
2	PW1C	1.4	0.35	0.19	54%	0.54	958	958
3	PW1D & PW1B2	1.4	1.36	1.14	84%	0.80	5,560	5,560
4	PW1E	1.4	0.21	0.12	57%	0.56	602	602
5	PW1F	1.4	0.10	0.08	80%	0.77	391	391
TOTAL	-	-	2.61	1.93	74%	0.72	9,491	9,491

The current design exceeds the requirement for treating the WQv for the impervious areas of new construction.

RUNOFF REDUCTION VOLUME

The runoff reduction volume (RRv) is designed to reduce the stormwater volume leaving the site by capturing an amount equal to the computed water quality volume and infiltrating it onsite. However, for sites that cannot reduce runoff in the amount equal to the water quality volume, a minimum RRv is allowed if the project demonstrates acceptable limitations. The minimum RRv requirement (in acre-feet) was calculated as follows:

$$RRv_{min} = [(P)(\bar{R}v)(S)(Aic)]/12 \text{ where,}$$

I = Percent Impervious Cover (must be 100%)
P = 90% rainfall event = 1.4
 $\bar{R}v = 0.05 + [(0.009)(I)] = 0.95$
S = Hydrologic Soil Group Reduction Factor = 0.20 for HSG D
Aic = Total Area of new impervious cover (acres) = **1.93**

$$RRv_{min} = \frac{[(P)(\bar{R}v)(S)(Aic)]}{12} = \frac{[(1.4)(0.95)(0.20)(1.93)]}{12} = 0.043 \text{ ac-ft} = \mathbf{1,863 \text{ cf}}$$

Runoff from the development has been treated using bioretention ponds. Within these proposed practices the entire WQv has not been reduced through the use of standard SMPs with RRv capacity. The RRv and for each proposed practice is included in Table 4 below.

TABLE 4 –RRv Volumes Provided

Catchment (GI Worksheet numbering)	Description (HydroCAD designation)	RRv Provided (cf)
1	PW1B1	978
2	PW1C	585
3	PW1D & PW1B2	3,306
4	PW1E	343
5	PW1F	200
TOTAL	-	5,412

The proposed design exceeds the minimum requirement by providing an RRv in excess of the minimum amount required and provides >100% of the water quality volume set forth by the NYSDEC requirements. This aspect of the design has been met.

RUNOFF REDUCTION VOLUME (RRV) THROUGH SITE PLANNING:

The application of site planning and green infrastructure to reduce water quality volume with runoff reduction practices can either reduce the required water quality volume to be treated or can completely account for the required water quality volume, which is recommended; the summary of this analysis can be found below. The combination of practices provided on site exceeds the minimum required water quality and runoff reduction for the proposed development.

The basic premise of runoff reduction is to recognize the water quality benefits of certain practices by allowing for a reduction in the water quality treatment volume. Runoff reduction is first achieved through better site design during the planning stages and has been implemented in the planning and design of this project as described in this report.

In accordance with Section 5.2 "Planning for Green Infrastructure: Reduction of Impervious Cover" of the NYSDEC Stormwater Management Design Manual, the proposed site plan has been designed to meet the planning techniques as follows:

TABLE 5: GREEN INFRASTRUCTURE SITE PLANNING

Preservation of Undisturbed Areas	
Delineate and place into permanent conservation undisturbed forests, native vegetated areas, riparian corridors, wetlands, and natural terrain.	This practice has not been applied to this project.
Preservations of Buffers	
Define, delineate, and preserve naturally vegetated buffers along perennial streams, rivers, shorelines and wetlands.	Existing federally regulated wetland areas exist on site which have been primarily preserved with the exception of a minor disturbance necessary for site access.
Reduction of Clearing & Grading	
Limit clearing and grading to the minimum amount needed for roads, driveways, foundations, utilities and stormwater management facilities.	The development has been limited as much as possible while still meeting the developer's requirements.
Locating Development in Less Sensitive Areas	
Avoid sensitive resource areas such as floodplains, steep slopes, erodible soils, wetlands, mature forests and critical habitats by locating development to fit the terrain in areas that will create the least impact.	Existing federally regulated wetland areas exist on site which have been primarily preserved with the exception of a minor disturbance necessary for site access.
Open Space Design	
Use clustering, conservation design or open space design to reduce impervious cover, preserve more open space and protect water resources.	Not applicable to this project.
Soil Restoration	
Restore the original properties and porosity of the soil by deep till and amendment with compost to reduce the generation of runoff and enhance the runoff reduction performance of post construction practices.	Compacted soils located in open areas without shallow utilities will be tilled in order to restore the original properties of the soil prior to seeding.
Roadway Reduction	
Minimize roadway widths and lengths to reduce site impervious area	Roadway widths were reduced wherever possible while still maintaining the necessary access.
Sidewalk Reduction	
Minimize sidewalk lengths and widths to reduce site impervious area	Sidewalks added where needed to serve the pedestrian needs adequately and safely of the facility.

Driveway Reduction	
Minimize driveway lengths and widths to reduce site impervious area	The proposed driveways have been minimized wherever possible.
Cul-de-Sac Reduction	
Minimize the number of cul-de-sacs and incorporate landscaped areas to reduce their impervious cover.	Not applicable to this project.
Building Footprint Reduction	
Reduce the impervious footprint of residences and commercial buildings by using alternate or taller buildings while maintaining the same floor to area ratio.	The building footprints have been designed to meet the developer's needs.
Parking Reduction	
Reduce imperviousness on parking lots by eliminating unneeded spaces, providing compact car spaces and efficient parking lanes, minimizing stall dimensions, using porous pavement surfaces in overflow parking areas, and using multi-storied parking decks where appropriate.	The site has been developed to meet the developer's needs and the applicable requirements.

GREEN INFRASTRUCTURE TECHNIQUES (GITS):

After taking into account the reductions through Site Planning mentioned above, RRv remains to be treated through GITs and/or Standard SMPs. Chapter 5 of the NYSSMDM outlines the various Green Infrastructure Techniques which can be implemented on-site to achieve runoff reduction. The GI Worksheets included in the Appendix of this report provide the calculations for the green infrastructure techniques chosen to treat the Runoff Reduction Volume for this project. Below is a brief description of each Green Infrastructure Technique along with a discussion regarding the feasibility of each technique with respect to this project.

TABLE 6: GREEN INFRASTRUCTURE FEASIBILITY

Conservation of Natural Areas	
Retain the pre-development hydrologic and water quality characteristics of undisturbed natural areas, stream and wetland buffers by restoring and/or permanently conserving these areas on a site.	Existing federally regulated wetland areas exist on site which have been primarily preserved except for a minor disturbance necessary for site access.
Sheet flow to Riparian Buffers or Filter Strips	

Undisturbed natural areas such as forested conservation areas and stream buffers or vegetated filter strips and riparian buffers can be used to treat and control stormwater runoff from some areas of a development project.	Wetland buffers remain around Monhagen Brook on site, however these features have not been quantified as stormwater mitigation.
Vegetated Open Swale	
The natural drainage paths, or properly designed vegetated channels, can be used instead of constructing underground storm sewers or concrete open channels to increase time of concentration, reduce the peak discharge, and provide infiltration.	Overland sheet flow and vegetated swales have been implemented as feasible, however these features have not been quantified as a stormwater mitigation.
Tree Planting/Tree Box	
Plant or conserve trees to reduce stormwater runoff, increase nutrient uptake, and provide bank stabilization. Trees can be used for applications such as landscaping, stormwater management practice areas, conservation areas and erosion and sediment control.	Tree planting has been proposed through the site but has not been quantified as a stormwater mitigation.
Disconnection of Rooftop Runoff	
Direct runoff from residential rooftop areas and upland overland runoff flow to designated pervious areas to reduce runoff volumes and rates.	Not applicable to this project.
Stream Daylighting for Redevelopment Projects	
Stream Daylight previously-culverted/ piped streams to restore natural habitats, better attenuate runoff by increasing the storage size, promoting infiltration, and help reduce pollutant loads.	Not applicable to the project.
Rain Garden	
Manage and treat small volumes of stormwater runoff using a conditioned planting soil bed and planting materials to filter runoff stored within a shallow depression.	Rain gardens are not proposed as part of this project since the use of other GITs is more practicable.
Green Roof	
Capture runoff by a layer of vegetation and soil installed on top of a conventional flat or sloped roof. The rooftop vegetation allows evaporation and	Not used.

evapotranspiration processes to reduce volume and discharge rate of runoff entering conveyance system.	
Stormwater Planter	
Small landscaped stormwater treatment devices that can be designed as infiltration or filtering practices. Stormwater planters use soil infiltration and biogeochemical processes to decrease stormwater quantity and improve quality.	Landscaping in green areas and planted beds are proposed throughout the development, but planters have not been proposed for treatment. No credit has been taken in the SWPPP.
Rain Tank or Cistern	
Capture and store stormwater runoff to be used for irrigation systems or filtered and reused for non-contact activities.	Not used.
Porous Pavement	
Pervious types of pavements that provide an alternative to conventional paved surfaces, designed to infiltrate rainfall through the surface, thereby reducing stormwater runoff from a site and providing some pollutant uptake in the underlying soils.	Porous pavers have not been used in this design.

The bioretention practices account for the runoff reduction as required.

Refer to Tables 5 and 6 above for the decision-making matrices utilized herein. The design for the project utilized a standard SMPs with RRV capacity to attain the required runoff reduction volume and water quality for new construction. NYSDEC Green Infrastructure (GI) worksheets can be found in Appendix 3 summarizing the calculations.

BIORETENTION BASINS WITH UNDERDRAIN (NO INFILTRATION):

The proposed development implements the use of bioretention with a proposed underdrain (F-5). Runoff from the development is proposed to be routed to a bioretention basin to provide runoff reduction capacity as well as water quality treatment volume. The basins are proposed with a 3” mulch layer, 2.5 feet of soil media, and an 8-inch drainage stone layer with a 6-inch underdrain that connects to an outlet control structure and discharges downstream to attenuate peak flows. Bioretention soils shall meet the design criteria outlined in Appendix H of the NYSSMDM.

The sizing calculation for the bioretention system was completed in accordance with design requirements set forth in Section 6.4.4 of the NYSSMDM. An exception to the design is that grass filter strips have not been provided in all locations for pre-treatment of the sheet flow from the paved areas. Frequent observance of scour and destruction of existing bioretention areas have led the design to include properly sized riprap inlet protection at all curb cuts and proper scour protection for discharging pipes. Although the intent of the design requires grass filter strips, we believe the longevity of the system design and maintenance of the mulch layer and vegetation will

adequately treat the runoff from the proposed development and this design alteration will meet the long-term goals of the permit. Hydrodynamic separator swirl chambers (proprietary devices designed as flow-through structures with a settling or separation unit to remove sediment and other pollutants) have also been included as pretreatment and hotspot removal devices.

Bioretention facilities must be carefully constructed following the recommendations in Appendix C of the design manual and preserving the natural porosity of the installed planting soils. Bioretention planting soil must be pre-mixed, stockpiled, lab tested for the necessary parameters, and submitted as a shop drawing for approval prior to installation.

The stage/storage information of the bioretention areas can be found in the HydroCAD output within the Appendix of this report. The NYSDEC GI worksheet for runoff reduction and water quality treatment can be found in the Appendix for RRv capacity calculations (See NYSDEC GI worksheets). A summary of the water quality provided in these facilities can be found in the Tables above.

In addition to the swirl chambers that have been included as pretreatment and hotspot runoff removal devices, bioretention areas accepting hotspot runoff (**BIO-1E**) will also have an impermeable liner to prevent hotspot runoff from infiltration and satisfy the requirements of the permit.

Figure 6.19 Bioretention (F-5)

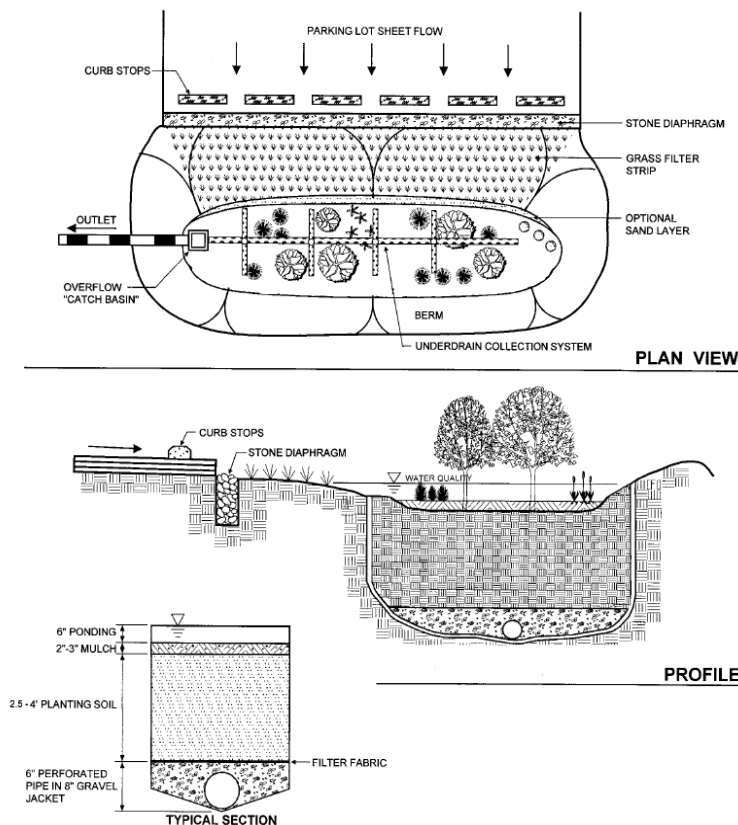

Hydrodynamic Separator (Swirl Chamber):

The applicant proposes to install a hydrodynamic separator to provide water quality pre-treatment and hotspot treatment as part of the “treatment train” upstream of the standard mitigation practices with Runoff reduction capacity. Hydrodynamic separators are devices that move water in a circular, centrifugal manner to accelerate the separation and deposition of primarily sediment from the water. They are suitable for removal of coarse particles, oils, and fuels over small drainage areas. The NYSDEC refers to the New Jersey Department of Environmental Protection for a list of Stormwater Manufactured Treatment Devices which have received Interim Certification (included in the Appendix). One of the products on the list is the Hydro International First Defense unit.

Sizing of the First Defense system (an alternative stormwater practice) requires the application of a “rate-based” sizing approach for water quality treatment. In the “rate-based” approach, the device should be sized to treat the peak rate of runoff from the WQv storm; utilizing the WQv storm precipitation depth, the peak runoff for each tributary area can then be determined, and the associated devices sized appropriately. HydroCAD was used to determine the water quality flow rate for treatment sizing of the First Defense system. The table below lists the water quality storm event, its associated flowrate for the treatment structure, the tributary catchments, and the appropriately sized First Defense system capacity which provides in excess of the required flow, for the location shown on the plans

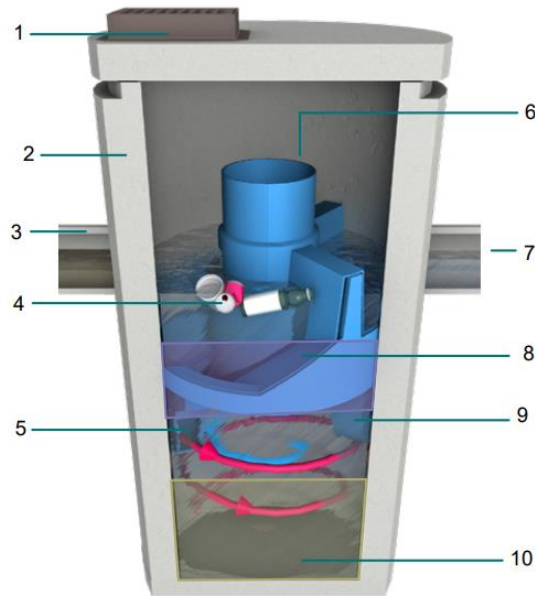

Components

- | | |
|---|-------------------------------|
| 1. Inlet Grate (optional) | 6. Internal Bypass |
| 2. Precast chamber | 7. Outlet pipe |
| 3. Inlet Pipe (optional) | 8. Oil and Floatables Storage |
| 4. Floatables Draw Off Slot
(not pictured) | 9. Outlet chute |
| 5. Inlet Chute | 10. Sediment Storage Sump |

Table 1. First Defense® High Capacity Design Criteria.

First Defense® High Capacity Model Number	Diameter	Typical TSS Treatment Flow Rates			Peak Online Flow Rate	Maximum Pipe Diameter ¹	Oil Storage Capacity	Typical Sediment Storage Capacity ²	Minimum Distance from Outlet Invert to Top of Rim ³	Standard Distance from Outlet Invert to Sump Floor
		NJDEP Certified	106µm	230µm						
	(ft / m)	(cfs / L/s)	(cfs / L/s)	(cfs / L/s)	(cfs / L/s)	(in / mm)	(gal / L)	(yd ³ / m ³)	(ft / m)	(ft / m)
FD-3HC	3 / 0.9	0.84 / 23.7	0.3 / 8.77	0.53 / 15.0	15 / 424	18 / 457	125 / 473	0.4 / 0.3	2.0 - 3.5 / 0.6 - 1.0	3.71 / 1.13
FD-4HC	4 / 1.2	1.50 / 42.4	0.7 / 20	1.2 / 34	18 / 510	24 / 600	191 / 723	0.7 / 0.5	2.3 - 3.9 / 0.7 - 1.2	4.97 / 1.5
FD-5HC	5 / 1.5	2.34 / 66.2	1.3 / 37.9	2.2 / 62.2	20 / 566	24 / 609	300 / 1135	1.1 / .84	2.5 - 4.5 / 0.7 - 1.3	5.19 / 1.5
FD-6HC	6 / 1.8	3.38 / 95.7	2.2 / 63	3.8 / 108	32 / 906	30 / 750	496 / 1,878	1.6 / 1.2	3.0 - 5.1 / 0.9 - 1.6	5.97 / 1.8
FD-8HC	8 / 2.4	6.00 / 169.9	5.1 / 144	8.6 / 243	50 / 1,415	48 / 1219	1120 / 4239	2.8 / 2.1	3.0 - 6.0 / 0.9 - 1.8	7.40 / 2.2

Contact Hydro International when larger pipe sizes are required.
¹Contact Hydro International when custom sediment storage capacity is required.
³Minimum distance for models depends on pipe diameter.

The First Defense treatment system has the capacity of bypassing high flow rates internally as well as controlling flow through the treatment chamber to avoid wash-out of previously captured pollutants. The HydroCAD output can be found in the Appendix of this report. Specifications for the First Defense Systems can also be found in the appendix of this report along with certification from NYSDEC that it is an accepted proprietary device. The NJCAT testing certification is also included within the Appendix.

Table 7: Swirl Chamber Sizing Calculations

Proposed First Defense System	90% Rainfall Event Number (P) Inches	Tributary Catchment Areas (WS-#)	Required Water Quality Flow, cfs	Hydro International First Defense Model	Treatment Capacity, cfs
H-1	1.40	PW1B1	0.49	FD-3HC	0.84
H-2		PW1B2	0.47	FD-3HC	0.84
H-3		PW1E	0.15	FD-3HC	0.84
H-4		PW1D	0.90	FD -4HC	1.50

VI. EROSION & SEDIMENT CONTROL

Construction operations shall be carried out in such a manner that erosion will be controlled and sediment migration minimized. Federal, State, and Local laws concerning pollution reduction will be followed. The control practices indicated on attached Erosion & Sediment Control Plans shall be installed and used on this project.

The list of measures and practices below are contained on the Erosion and Sediment Control Plans in the appendix of this report and shall be installed and maintained per the most current edition of the New York Standard Specifications for Erosion and Sediment Control Handbook (“Bluebook”). All erosion control measures implemented shall be in accordance with the construction sequence schedule as described in Section VIII of this narrative.

Infiltration areas must be always protected from sedimentation during construction until all tributary areas have met the criteria of final stabilization. Engineered bioretention soils cannot be installed in the ponds until tributary areas have been stabilized unless the soil media is otherwise protected runoff that could compromise the composition of the soil media.

303(d) Segments Impaired by Construction related pollutants

As stated earlier in this report, the site design point discharges to a tributary of the Monhagen Brook, a waterbody listed on the 303(d) list within the general permit. As such, the following requirements will need to be met during construction.

- For construction sites that directly discharge to one of the 303(d) segments listed in Appendix E or is located in one of the watersheds listed in Appendix C of GP-0-25-001, the qualified inspector shall conduct at least two (2) site inspections every seven (7) calendar days. The two (2) inspections shall be separated by a minimum of two (2) full calendar days.
- For construction sites that directly discharge to one of the 303(d) segments listed in Appendix E or is located in one of the watersheds listed in Appendix C of GP-0-25-001, the application of soil stabilization measures must be initiated by the end of the next business day and completed within seven (7) days.

Temporary Measures

Silt Fence – Silt fence shall be placed along the toe of all fill areas or any location where surface sheet flow could be expected in accordance with temporary soil erosion and sediment control plans serving to reduce runoff velocity and effect deposition of transported sediment load. Where silt fence ends, the end shall turn and run perpendicular to contours for a length of ten (10) feet, or for a difference in elevation of two (2) feet, whichever comes first.

Mulching – Mulching of all disturbed surfaces will be mandatory. Hydroseeding with mulch only mixes will be the preferred method.

Stabilized Construction Access - A stabilized pad of aggregate underlain with geotextile located at any point where traffic will be entering or leaving a construction site to or from a public right-of-way, street, alley, sidewalk, or parking area. The purpose of stabilized construction access is to reduce or eliminate the tracking of sediment onto public rights-of-way or streets.

The access shall be maintained in a condition which will prevent tracking of sediment onto public rights-of-way or streets. This may require periodic top dressing with additional aggregate. All sediment spilled, dropped, or washed onto public rights-of-way must be removed immediately. When necessary, wheels must be cleaned to remove sediment prior to entrance onto public rights-of-way. When washing is required, it shall be done on an area stabilized with aggregate, which drains into an approved sediment trapping device. All sediment shall be prevented from entering storm drains, ditches, or watercourses.

Concrete Washout Station - A temporary concrete washout station is to be used near the entrance to the site. The station will have a depth of 24 inches and shall be a minimum of 10 feet by 10 feet. Station shall be lined with a 10mil waterproof plastic membrane. Any tools or equipment that were used for concrete work will be cleaned here before leaving the site.

Permanent Measures

Topsoil, Seed & Mulch – Final vegetative stabilization shall be used at all locations where the ground has been disturbed and impervious covers are not specified. Mulch shall be applied with, or immediately after seeding.

Rock outlet protection- Stone riprap is to be placed at the outlet end of the culverts beneath the flared end section to slow down the flow of the runoff and reduce erosion.

Maintenance and Inspection of Measures

All temporary and permanent soil erosion and sediment measures shall be maintained by the contractor during the life of the project. The contractor shall have a trained contractor, as defined in the GP-0-25-001 (See Appendix 4) on site at all times. The trained contractor shall be responsible for the day-to-day construction and maintenance of all erosion and sediment control measures.

All temporary measures (silt fence, inlet protection, silt sock, sediment basins, etc.) and permanent measures (landscaping) shall be inspected by the Qualified Inspector every seven calendar days. The Qualified Inspector role and inspection requirements are outlined in Part IV.C of the GP-0-25-001 (See Appendix 4). All inspections are required to be completed within one calendar day. Any comments, suggestions or corrective actions the Qualified Inspector notes shall be addressed by the contractor within 24 hours of the inspection.

General Enhanced Erosion and Sediment Control Plan for Projects in Sensitive Watersheds:

- Enlarged sediment ponds or sediment storage traps utilizing the maximum practical area in excess of the minimum amount recommended in the Bluebook
- Apply slope protection measures within 3 days after earthmoving on a particular

slope is complete.

- Install reinforced silt fences with hay bale or silt sock backing along wetlands or other sensitive areas.
- Install bonded fiber matrix hydraulically applied mulch as temporary stabilization (hay/straw mulch and unbonded hydraulically applied mulches are not acceptable)
- Install flexible growth medium with seed, soil amendment, and fertilizer to seek final stabilization
- Perform equipment (cat) tracking for bare slopes to be protected. (See page 4.56 of the Bluebook)
- Install slope crest protection (perimeter dike/swale) measures to divert flow from going down the newly graded slope. (See page 3.36 of the Bluebook)
- Install pipe slope drains. (See page 3.37 of the Bluebook) Install reverse slope bench on the long slopes to convey water to a stable outlet. (See page 4.24 of the Bluebook)
- Install Geosynthetic Turf Reinforcement Mats available from Profile Products or equal on the embankments of sediment basins; immediately following construction. (See pages 5.19 to 5.41 of the Bluebook)
- Install Geosynthetic Turf Reinforcement Mats available from Profile Products or equal in temporary diversion ditches within two days of construction to stabilize the ditch.
- Install floating water skimmers connected to the outlet riser pipe in sedimentation ponds (See attached diagrams)
- Install sediment filter bags on the downstream end of the outlet pipe. (See page 5.16 of the Bluebook)
- Design sedimentation pond to maximize the sediment residence time. (See pages 5.19 to 5.41 of the Bluebook)
- Address the disposal or storage of sediment cleaned from sediment control devices, sediment ponds, ditches, and drainage inlets.
- Stabilize construction access roads with crushed stone, item 4, etc.
- Assign a dedicated and trained crew to maintain and repair erosion and sediment control measures daily.
- Install hydroseed & erosion control matting on all disturbed slopes 3H:1V or steeper
- Follow NYSDEC guidelines which limit the maximum soil disturbance area to 18 acres at any given time (or 5 acres max for projects not seeking 5-acre disturbance waiver). Temporary stabilization must be utilized in inactive areas to manage the amount of active open soil disturbance.

Construction Sequence:

All work to be done in accordance with the New York Standards and Specifications for Erosion and Sediment Control. See the Erosion & Sediment Control Plan included in the appendix of this report which has general erosion and sediment control notes and a sequence of construction, which can also be found below.

The erosion control practices designed specifically for the site phasing are to be implemented during construction. These include sediment traps, inlet protection, a stabilized construction entrance, staging areas, silt fence, temporary swales, temporary stockpiles, temporary sediment ponds, silt socks, erosion control matting/blankets, and temporary/permanent stabilization. The E&SC Plan and Details found in the appendix of this report depict the location and size of the proposed erosion control practices to be used during construction.

A sediment trap detail and sizing criteria chart has been provided on the plan. This chart identifies overall required storage per the area of disturbance as well as sub-areas and dimensions of traps to be utilized. These sizes and volumes are required through the device can be relocated as practical by the Contractor (note: traps must be sized to provide 3,600 CF of storage per 1-acre of disturbance and tributary to each location). It is recommended to provide increased storage in excess of the required volume.

Sediment Pond Restoration: When temporary structures have served their intended purpose and the contributing drainage area has been properly stabilized, the embankment and resulting sediment deposits are to be leveled or otherwise disposed of. Sediment can be disposed of by exporting it off site for disposal or be used as fill in lawn areas. Sediment ponds in future open space or lawn areas may be pumped dry, graded, and backfilled. Sediment ponds in paved or structural areas must have the basin material and trapped sediments removed, safely disposed of, and backfilled with structural fill. Sediment ponds in locations of future stormwater ponds must have the trapped sediment removed leaving the basin area open for the development of the final stormwater pond.

The applicant and the applicant's contractor are required to attend a preconstruction meeting with representatives from the Town Building Departments, Highway Departments, Engineers and any other parties deemed necessary to review all protocols, bonding requirements, agreements and the sequence and scheduling of the work being undertaken, as applicable.

Construction Sequencing:

Refer to the erosion & sediment controls plans included as an appendix to this report for construction limit of disturbance, recommended temporary sediment basin sizing, and other recommended erosion control measures.

1. The contractor must first delineate and protect the wetlands and associated buffer areas. Install construction entrances and all applicable erosion control measures as shown on the plan, including silt fencing and temporary swales. Establish staging areas.
2. Install a diversion berm along the frontage as indicated on the plan and install a clean water bypass pipe beneath the construction entrance to divert runoff from the east along Dolsontown Road away from the work area.
3. Contractor shall install the temporary sediment basins as indicated on the site plan and/or as required to construct the project while maintaining functionality of the necessary storage. Contractor to construct additional temporary diversion swales and sediment traps as needed to direct and capture runoff from disturbed areas. Locations and size of the erosions and sediment

control practices are noted on the plan. These may vary depending on the contractor's schedule and approach but 3,600 cf of storage must be provided at a minimum per acre of upstream disturbance. Sediment traps shall be installed in accordance with the plans and details. Sediment traps and basins shall be sized in accordance with the New York Standards and Specifications for Erosion and Sediment Control Manual. Sediment ponds should have non-erosive inlets and the embankments should be stabilized with vegetation or mechanical control measures to minimize turbidity of the stored water to the maximum extent practical.

4. Disturbed soils shall be temporarily stabilized as soon as practical. Materials stored in stockpiles shall be cordoned off with silt fence per the appropriate specifications and details. The operator shall initiate stabilization measures as soon as practical in portions of the site where construction activities have temporarily or permanently ceased, but in no case more than (14) days after the construction activity in that portion of the site has temporarily or permanently ceased.

Temporary Stabilization - means that exposed soil has been covered with material(s) as set forth in the technical standard, New York Standards and Specifications for Erosion and Sediment Control, to prevent the exposed soil from eroding. The materials can include, but are not limited to, mulch, seed and mulch, and erosion control mats (e.g. jute twisted yarn, excelsior wood fiber mats). Stabilization shall be maintained per SPDES General Permit for stormwater runoff from construction activity, GP-0-25-001 or as amended.

5. The Contractor shall grade the site systematically, installed stone roadways in heavily trafficked areas and installing pavement subbase materials as soon as practical to minimize the amount of actively open soil area. Remove soil/rock/stockpile excess material as necessary. The contractor will then install the site utilities and remaining retaining walls. Temporary swales must be used throughout the grading process to ensure runoff is always directed towards a sediment pond prior to discharging the site.
6. The subbase and curbing shall be installed as soon as practicable to provide a stabilized surface.
7. Once the areas upland of the sediment traps/basins have been stabilized, the bioretention systems, underdrains, and soil media can be installed. All upstream structures must have adequate inlet protection prior to the system being place on-line.
8. Grade and spread topsoil on all lawn areas and seed, install sidewalks. Maintain all seeded and planted areas to insure a viable stabilized vegetative cover.
9. The project site must meet final stabilization criteria prior to removing all erosion and sediment control devices and closing out the project. Litter and construction debris shall be removed as practical throughout the life of the project.
 - Final Stabilization means that all soil disturbance activities have ceased and a uniform, perennial vegetative cover with a density of eighty (80) percent over the entire pervious surface has been established; or other equivalent stabilization measures, such as

permanent landscape mulches, rock rip-rap or washed/crushed stone have been applied on all disturbed areas that are not covered by permanent structures, concrete or pavement.

10. Upon final stabilization being met, Contractor shall clear the drainage system, drainage pipe, and all existing and new structures on site of any sediment which may have accumulated during construction.
11. Additional erosion control measures shall be installed, as may be necessary, required and/or requested by authorities, to prevent the incidental discharge of silt laden runoff from entering a water course or a drainage system. The general permit for stormwater discharges from construction activities states that it is unlawful for any person to cause or contribute to a violation of water quality standards.

For additional, general Erosion and Sediment Control notes including seeding, please refer to the latest Erosion and Sediment Control Plans.

VII. GOOD HOUSEKEEPING

Good housekeeping practices are inexpensive, relatively easy to implement and are often effective in preventing stormwater contamination. Specific activities that should be completed by the contractor are listed below:

SPILL INVENTORY

The materials or substances listed below are expected to be present on-site during construction:

- Concrete
- Fertilizers
- Piping
- Paints (enamel & latex)
- Treated and non-treated wood
- Seed
- Tar
- Petroleum-based products
- Reinforcing steel
- Cleaning solvents
- Masonry block
- Paving materials

MATERIAL MANAGEMENT PRACTICES

The following are the material management practices that shall be used to reduce the risk of spills or other accidental exposure of materials and substances to stormwater runoff:

- Products shall be kept in original containers unless they are not re-sealable.

- Original labels and material safety data sheets (MSDS) shall be retained; they contain important product information.
- An effort shall be made to store only enough products required to do the job.
- All materials stored onsite shall be stored in a neat, orderly manner in their appropriate containers, and if possible, under a roof or other enclosure and/or on non-porous blacktop.
- Products shall be kept in their original containers with the original manufacturer's label.
- Substances shall not be mixed with one another unless recommended by the manufacturer.
- Whenever possible, all of a product shall be used up before disposing of the container.
- Manufacturer's recommendations for proper use and disposal shall be followed.
- The contractor's site superintendent shall inspect daily to ensure proper use and disposal of materials on site.

SPILL CONTROL PRACTICES

In addition to the good housekeeping and material management practices discussed in the previous sections of this plan, the following practices shall be followed for spill prevention and cleanup.

- Spills, of any size, of toxic or hazardous material and/or petroleum products shall be reported to the NYSDEC and Central Hudson's Environmental Affairs division.
- Manufacturer's recommended methods for spill cleanup shall be clearly posted and site personnel shall be made aware of the procedures and the locations of the information and cleanup supplies.
- Materials and equipment necessary for spill cleanup shall be kept in the material storage area onsite. Equipment and materials shall include but not be limited to brooms, dust pans, mops, rags, gloves, kitty litter, sand, sawdust, and plastic and metal trash containers specifically for this purpose.
- All spills shall be cleaned up immediately after discovery.
- The spill area shall be kept well ventilated, and personnel shall wear appropriate protective clothing to prevent injury from contact with a hazardous substance.
- The spill prevention plan shall be adjusted to include measures to prevent toxic or hazardous material of spills from recurring and how to clean up the spill. A description of the spill, what caused it, and the cleanup measures shall also be included.

The contractor's site superintendent is responsible for the day-to-day site operations and shall be the spill prevention and cleanup coordinator.

PRODUCT SPECIFIC PRACTICES

The following product specific practices shall be followed onsite.

- Petroleum Products – All onsite vehicles shall be monitored for leaks and receive regular preventive maintenance to reduce the chance of leakage. Petroleum products shall be stored in tightly sealed containers that are clearly labeled. Any asphalt substances used on site shall be applied according to manufacturer's recommendations.
- Fertilizers- Fertilizers shall be applied only in the minimum amounts recommended by the manufacturer. Use only fertilizers that have 5 or less parts phosphorous. Once applied, fertilizers shall be worked into the soil to limit exposure to stormwater. Storage shall be in a

covered shed. The contents of any partially used bags of fertilizer shall be transferred to a sealable plastic bin to avoid spills.

- Paints – All containers shall be tightly sealed and stored when not required for use. Excess paint shall not be discharged to the storm sewer system but shall be properly disposed of according to the manufacturer’s instructions or state and local regulations.
- Concrete Trucks – Concrete trucks shall not be allowed to wash out or discharge surplus concrete or drum wash water on the site, unless in approved clean-out areas.
- Waste Disposal – All waste materials shall be collected and stored in a securely lidded metal dumpster rented from a licensed solid waste management company. The dumpster shall meet all local and any State solid waste management regulations. All trash and construction debris from the site shall be deposited in the dumpster. The dumpster shall be emptied as necessary, and the trash shall be hauled to a NYSDEC permitted landfill. No construction waste materials shall be buried onsite. All personnel shall be instructed regarding the correct procedure for waste disposal.
- Hazardous Waste – All hazardous waste materials shall be disposed of in a manner specified by local or State regulations or the manufacturer. Site personnel shall be instructed in these practices.
- Sanitary Waste – All sanitary waste shall be collected from the portable units by a licensed sanitary waste management contractor, as required by local regulation and as required to protect public health and safety.
- Recyclable Waste – All recyclable waste (cardboard, wood, etc.) shall be collected and recycled on a weekly schedule.

VIII. RESPONSIBLE PARTIES

IMPLEMENTATION OF SWPPP

The owner/operator is responsible for implementing the provisions of the SWPPP and ensuring that the appropriate contractors and subcontractors on the site provide certification in accordance with the provisions of the GP-0-25-001.

The owner/operator is also responsible to have a trained contractor and Qualified Inspector inspect the active construction site in accordance with section 6.3 of this report and all provisions for inspections defined in the GP-0-25-001, (See Appendix 4). A trained contractor cannot conduct Qualified Inspector site inspections unless they meet the Qualified Inspector qualifications listed in appendices of the GP-0-25-001.

INSPECTION REQUIREMENTS

The owner/operator is responsible for implementing inspections of all erosion and sediment control measures. To do so, the owner/operator shall have a Qualified Inspector inspect the site in

accordance with the guidelines of Part IV of the GP-0-25-001. A sample inspection template is provided in the Appendix of this report.

The owner/operator shall maintain a record of all inspection reports in a site logbook. The site logbook shall be kept on site and be made available to the permitting authority upon request. The owner/operator shall also retain a copy of this SWPPP document at the construction site during the life of the project.

IX. END OF PROJECT – TERMINATION OF PERMIT

FINAL INSPECTION

Prior to filing the Notice of Termination (NOT), or at the end of permit term, the owner/operator shall have a *Qualified Inspector* perform a final site inspection. The inspector shall certify that the site has undergone final stabilization using either vegetative or structural stabilization methods. Final stabilization means that all soil-disturbing activities at the site have been completed and a uniform, perennial vegetative cover with a density of 80% has been established on all unpaved areas and areas not covered by permanent structures.

NOTICE OF TERMINATION

When the site has been finally stabilized, the owner/operator must submit a Notice of Termination (NOT) form to terminate coverage under SPDES General Permit GP-0-25-001. The permittee must identify all of the permanent stormwater management structures that have been constructed. In addition, a manual describing the operation and maintenance practices that will be necessary for the structure(s) to function as designed after the site is stabilized must be developed and in place. The permittee must also certify that the permanent structure(s) have been constructed in conformance with this document. A copy of the Notice of Termination (NOT) is provided in the Appendix of this report.

RECORD KEEPING

The owner/operator shall retain copies of SWPPP, any reports submitted in conjunction with this permit, and records of all data used to complete the NOI & NOT for a period of at least five (5) years from the date that the site is finally stabilized.

X. SUMMARY OF PROPOSED STORMWATER IMPROVEMENTS

The site runoff has been attenuated for peak flows in the peak design storms. The new impervious area has been treated for the required water quality and runoff reduction through the use of bioretention ponds. The design utilizes DEC approved practices that help maintain the existing hydrology.

XI. CONCLUSION

As the storm water pollution prevention plan provides water quality treatment and peak flow mitigation meeting the applicable standards, there should be no adverse impacts due to storm water, on-site or off-site, as a result of the proposed development.

r:\projects\2020\20006912d\reports\drainage\dewpoint north\january 2025 - r3\report\pieces\241118_swppp r3- rdm dewpoint north.docx



Engineering & Design

Colliers Engineering & Design is a trusted provider of multi-discipline engineering, design and consulting services providing customized solutions for public and private clients through a network of offices nationwide.

For a full listing of our office locations, please visit colliersengineering.com.

1 877 627 3772



*Civil/Site • Traffic/Transportation • Governmental • Survey/Geospatial
Infrastructure • Geotechnical/Environmental • Telecommunications • Utilities/Energy*

Appendix 1 | Watershed Maps

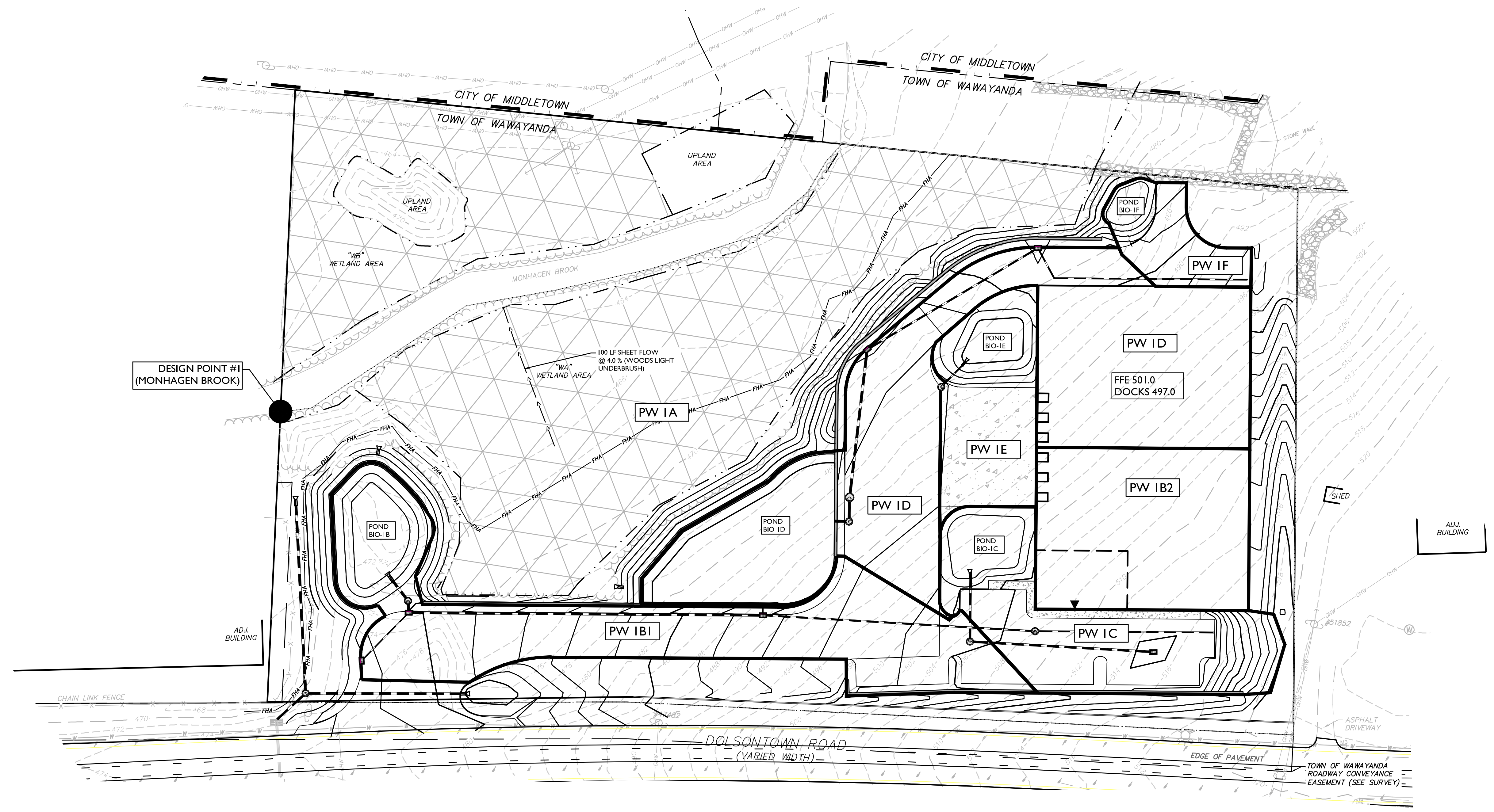
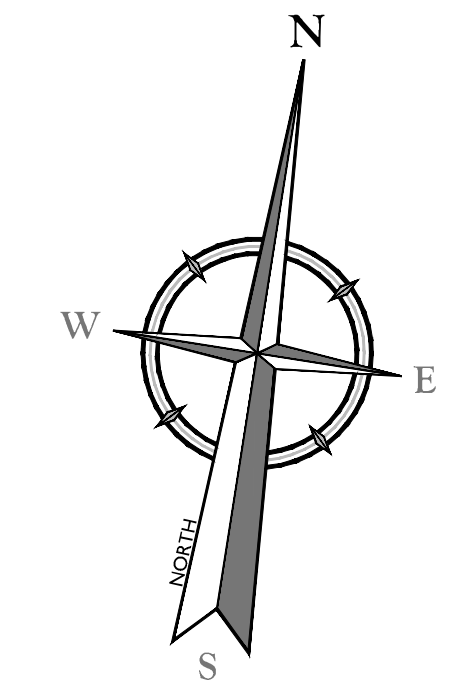

REV	DATE	DESCRIPTION
1	07/15/25	REVISED PER PLANNING BOARD COMMENTS.

WATERSHED MAPS
FOR
DEWPOINT NORTH
LLC

SECTION 4,
BLOCK 1
LOTS 50.2
TOWN OF WAWAYANDA
ORANGE COUNTY
NEW YORK STATE

Colliers NEWBURGH
555 Hudson Valley Avenue
Suite 101
New Windsor, NY 12553
Phone: 845.564.4495
Engineering & Design
COLLIERS ENGINEERING & DESIGN, P.C.
REGISTERED PROFESSIONAL ENGINEERS AND LAND SURVEYORS, P.A.
A PROFESSIONAL CORPORATION

SCALE: AS SHOWN	DATE: 12/14/2021	DRAWN BY: CDR	CHECKED BY: ABF
PROJECT NUMBER: 20005912A	DRAWING NAME: C-DRNG-NRTH		

SHEET TITLE:
**PROPOSED CONDITIONS
WATERSHED MAP**

SHEET NUMBER:
2 of 2

NOTES:
1. DRAINAGE AREAS WITHOUT TRAVEL TIME & PATH INDICATED UTILIZE THE MINIMUM TC OF 6 MINUTES.
2. ALL ONSITE SOIL IS CLASSIFIED AS HSG D SOILS.

40 0 40 80
SCALE: 1" = 40'

Appendix 2a | HydroCAD Data (Existing)

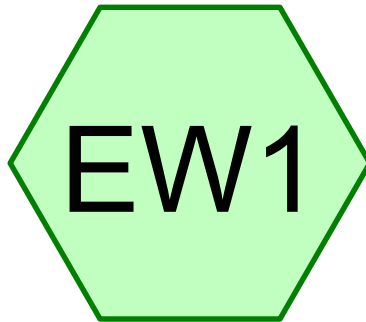

WS 1

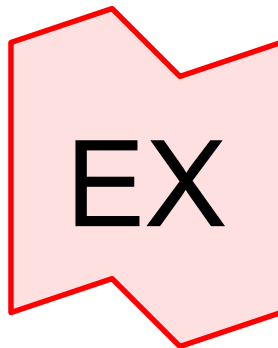

DP1 (EXISTING)

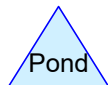
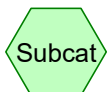

250109 Dewpoint North R3

Prepared by Colliers Engineering & Design

HydroCAD® 10.20-5c s/n 04431 © 2023 HydroCAD Software Solutions LLC

Printed 1/10/2025

Page 2

Rainfall Events Listing (selected events)

Event#	Event Name	Storm Type	Curve	Mode	Duration (hours)	B/B	Depth (inches)	AMC
1	1-yr	Type III 24-hr		Default	24.00	1	2.64	2
2	10-yr	Type III 24-hr		Default	24.00	1	4.68	2
3	100-yr	Type III 24-hr		Default	24.00	1	8.22	2

250109 Dewpoint North R3

Prepared by Colliers Engineering & Design

HydroCAD® 10.20-5c s/n 04431 © 2023 HydroCAD Software Solutions LLC

Type III 24-hr 1-yr Rainfall=2.64"

Printed 1/10/2025

Page 3

Summary for Subcatchment EW1: WS 1

Runoff = 3.15 cfs @ 12.25 hrs, Volume= 14,588 cf, Depth= 0.78"

Routed to Link EX : DP1 (EXISTING)

Runoff by SCS TR-20 method, UH=SCS, Weighted-CN, Time Span= 0.00-30.00 hrs, dt= 0.05 hrs
 Type III 24-hr 1-yr Rainfall=2.64"

Area (sf)	CN	Description
1,568	98	Paved parking, HSG D
7,928	84	50-75% Grass cover, Fair, HSG D
72,789	73	Brush, Good, HSG D
141,918	77	Woods, Good, HSG D
224,203	76	Weighted Average
222,635		99.30% Pervious Area
1,568		0.70% Impervious Area

Tc (min)	Length (feet)	Slope (ft/ft)	Velocity (ft/sec)	Capacity (cfs)	Description
12.4	100	0.0800	0.13		Sheet Flow, Woods: Light underbrush n= 0.400 P2= 3.17"
2.6	297	0.1481	1.92		Shallow Concentrated Flow, Woodland Kv= 5.0 fps
1.4	103	0.0580	1.20		Shallow Concentrated Flow, Woodland Kv= 5.0 fps
16.4	500	Total			

Subcatchment EW1: WS 1

Hydrograph

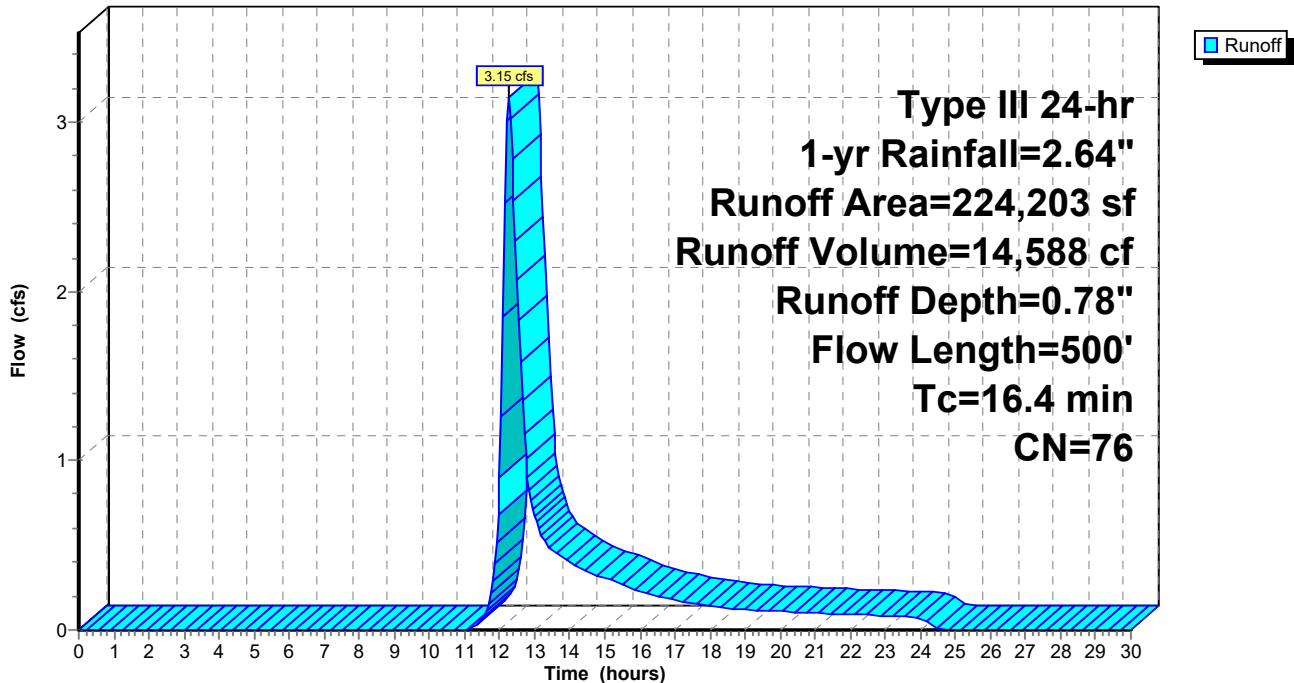

250109 Dewpoint North R3

Prepared by Colliers Engineering & Design

HydroCAD® 10.20-5c s/n 04431 © 2023 HydroCAD Software Solutions LLC

Type III 24-hr 1-yr Rainfall=2.64"

Printed 1/10/2025

Page 4

Summary for Link EX: DP1 (EXISTING)

Inflow Area = 224,203 sf, 0.70% Impervious, Inflow Depth = 0.78" for 1-yr event
Inflow = 3.15 cfs @ 12.25 hrs, Volume= 14,588 cf
Primary = 3.15 cfs @ 12.25 hrs, Volume= 14,588 cf, Atten= 0%, Lag= 0.0 min

Primary outflow = Inflow, Time Span= 0.00-30.00 hrs, dt= 0.05 hrs

Link EX: DP1 (EXISTING)

Hydrograph

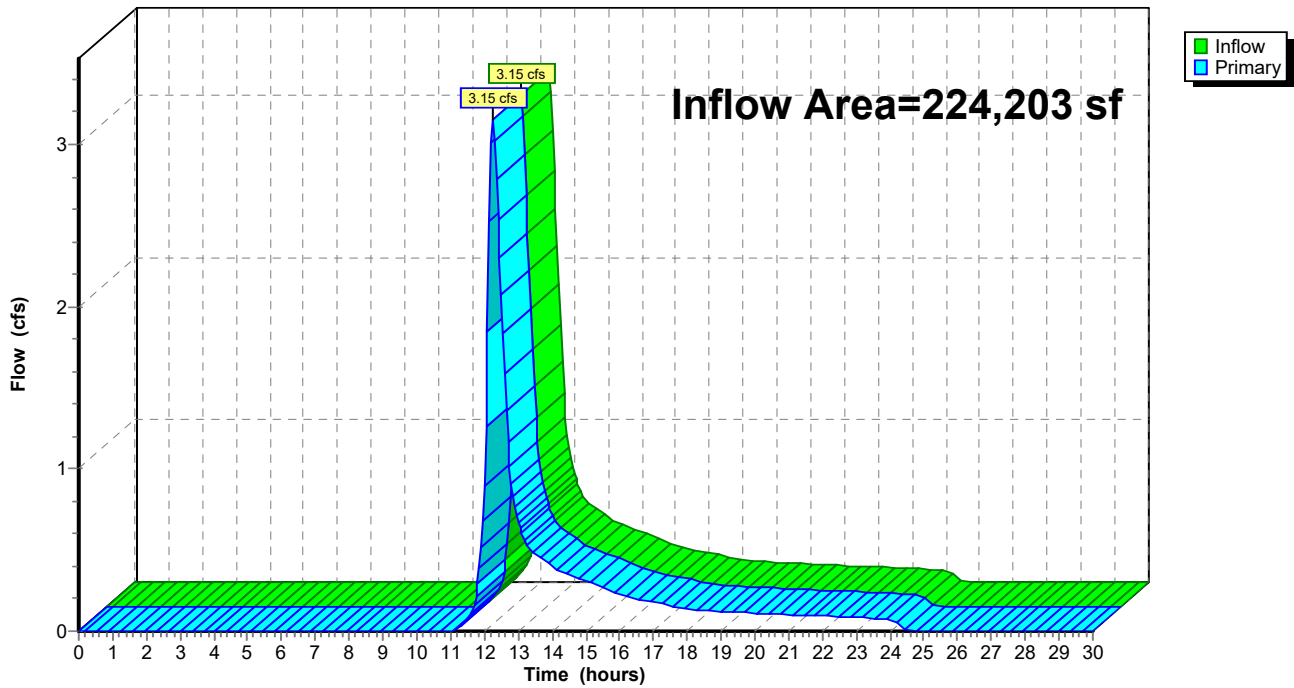

250109 Dewpoint North R3

Prepared by Colliers Engineering & Design

HydroCAD® 10.20-5c s/n 04431 © 2023 HydroCAD Software Solutions LLC

Type III 24-hr 10-yr Rainfall=4.68"

Printed 1/10/2025

Page 5

Summary for Subcatchment EW1: WS 1

Runoff = 9.91 cfs @ 12.23 hrs, Volume= 42,493 cf, Depth= 2.27"

Routed to Link EX : DP1 (EXISTING)

Runoff by SCS TR-20 method, UH=SCS, Weighted-CN, Time Span= 0.00-30.00 hrs, dt= 0.05 hrs
 Type III 24-hr 10-yr Rainfall=4.68"

Area (sf)	CN	Description
1,568	98	Paved parking, HSG D
7,928	84	50-75% Grass cover, Fair, HSG D
72,789	73	Brush, Good, HSG D
141,918	77	Woods, Good, HSG D
224,203	76	Weighted Average
222,635		99.30% Pervious Area
1,568		0.70% Impervious Area

Tc (min)	Length (feet)	Slope (ft/ft)	Velocity (ft/sec)	Capacity (cfs)	Description
12.4	100	0.0800	0.13		Sheet Flow, Woods: Light underbrush n= 0.400 P2= 3.17"
2.6	297	0.1481	1.92		Shallow Concentrated Flow, Woodland Kv= 5.0 fps
1.4	103	0.0580	1.20		Shallow Concentrated Flow, Woodland Kv= 5.0 fps
16.4	500	Total			

Subcatchment EW1: WS 1

Hydrograph

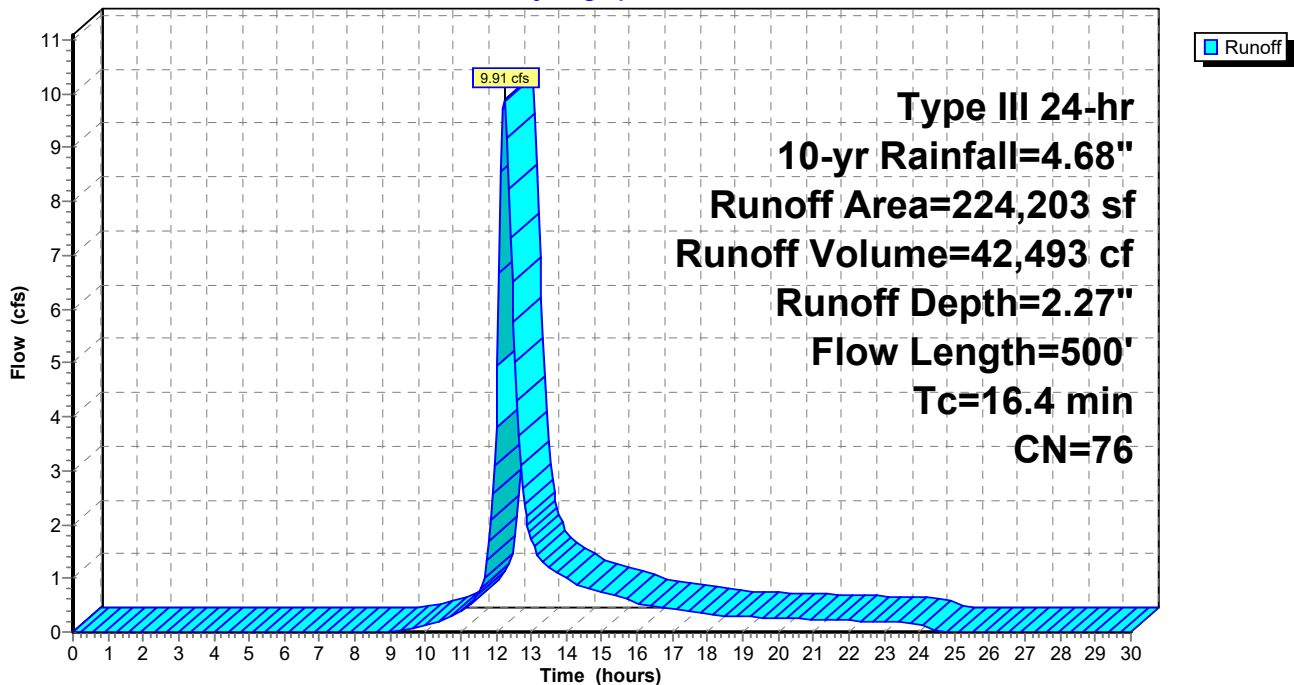

Summary for Link EX: DP1 (EXISTING)

Inflow Area = 224,203 sf, 0.70% Impervious, Inflow Depth = 2.27" for 10-yr event
Inflow = 9.91 cfs @ 12.23 hrs, Volume= 42,493 cf
Primary = 9.91 cfs @ 12.23 hrs, Volume= 42,493 cf, Atten= 0%, Lag= 0.0 min

Primary outflow = Inflow, Time Span= 0.00-30.00 hrs, dt= 0.05 hrs

Link EX: DP1 (EXISTING)

Hydrograph

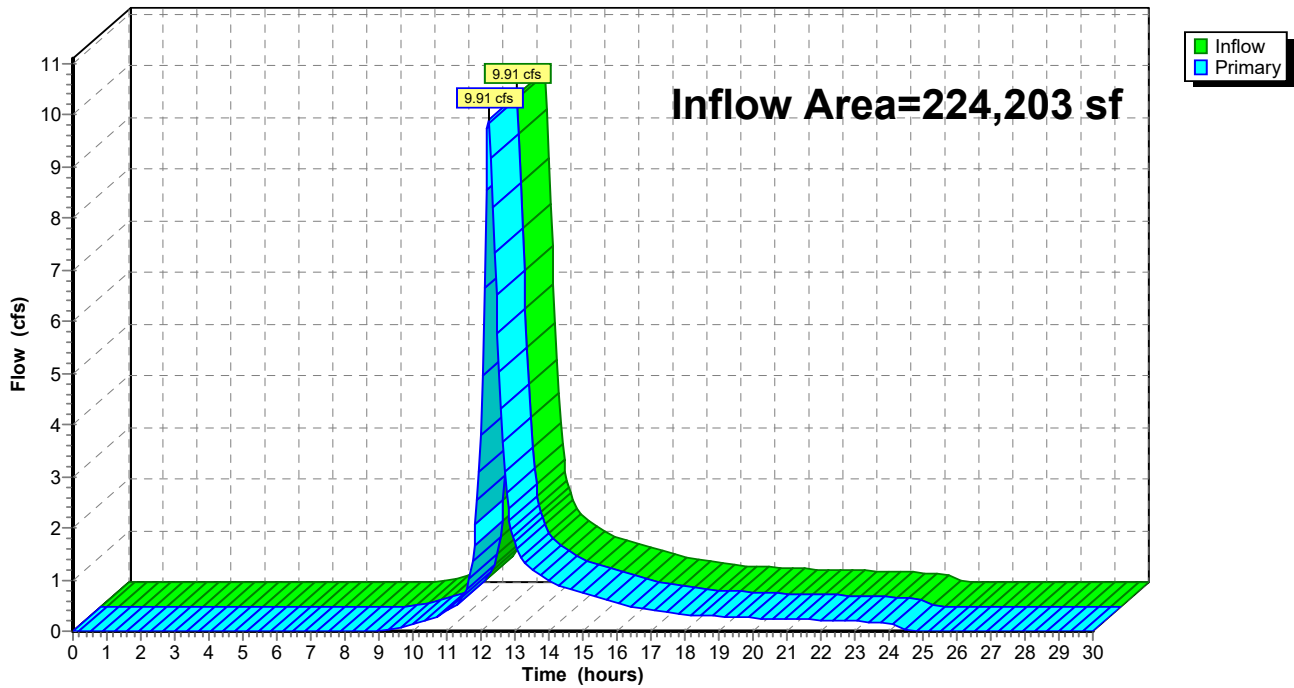

250109 Dewpoint North R3

Type III 24-hr 100-yr Rainfall=8.22"

Prepared by Colliers Engineering & Design

Printed 1/10/2025

HydroCAD® 10.20-5c s/n 04431 © 2023 HydroCAD Software Solutions LLC

Page 7

Summary for Subcatchment EW1: WS 1

Runoff = 23.46 cfs @ 12.22 hrs, Volume= 100,116 cf, Depth= 5.36"

Routed to Link EX : DP1 (EXISTING)

Runoff by SCS TR-20 method, UH=SCS, Weighted-CN, Time Span= 0.00-30.00 hrs, dt= 0.05 hrs
Type III 24-hr 100-yr Rainfall=8.22"

Area (sf)	CN	Description
1,568	98	Paved parking, HSG D
7,928	84	50-75% Grass cover, Fair, HSG D
72,789	73	Brush, Good, HSG D
141,918	77	Woods, Good, HSG D
224,203	76	Weighted Average
222,635		99.30% Pervious Area
1,568		0.70% Impervious Area

Tc (min)	Length (feet)	Slope (ft/ft)	Velocity (ft/sec)	Capacity (cfs)	Description
12.4	100	0.0800	0.13		Sheet Flow, Woods: Light underbrush n= 0.400 P2= 3.17"
2.6	297	0.1481	1.92		Shallow Concentrated Flow, Woodland Kv= 5.0 fps
1.4	103	0.0580	1.20		Shallow Concentrated Flow, Woodland Kv= 5.0 fps
16.4	500	Total			

Subcatchment EW1: WS 1

Hydrograph

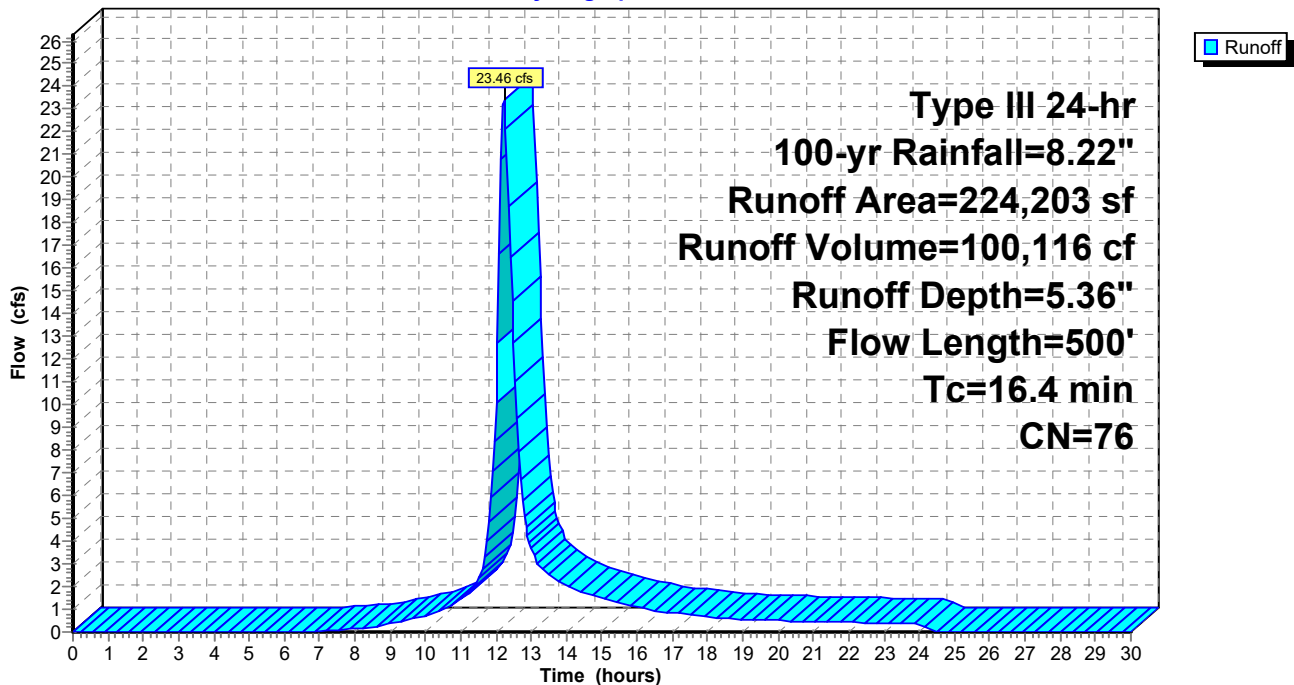

250109 Dewpoint North R3

Prepared by Colliers Engineering & Design

HydroCAD® 10.20-5c s/n 04431 © 2023 HydroCAD Software Solutions LLC

Type III 24-hr 100-yr Rainfall=8.22"

Printed 1/10/2025

Page 8

Summary for Link EX: DP1 (EXISTING)

Inflow Area = 224,203 sf, 0.70% Impervious, Inflow Depth = 5.36" for 100-yr event
Inflow = 23.46 cfs @ 12.22 hrs, Volume= 100,116 cf
Primary = 23.46 cfs @ 12.22 hrs, Volume= 100,116 cf, Atten= 0%, Lag= 0.0 min

Primary outflow = Inflow, Time Span= 0.00-30.00 hrs, dt= 0.05 hrs

Link EX: DP1 (EXISTING)

Hydrograph

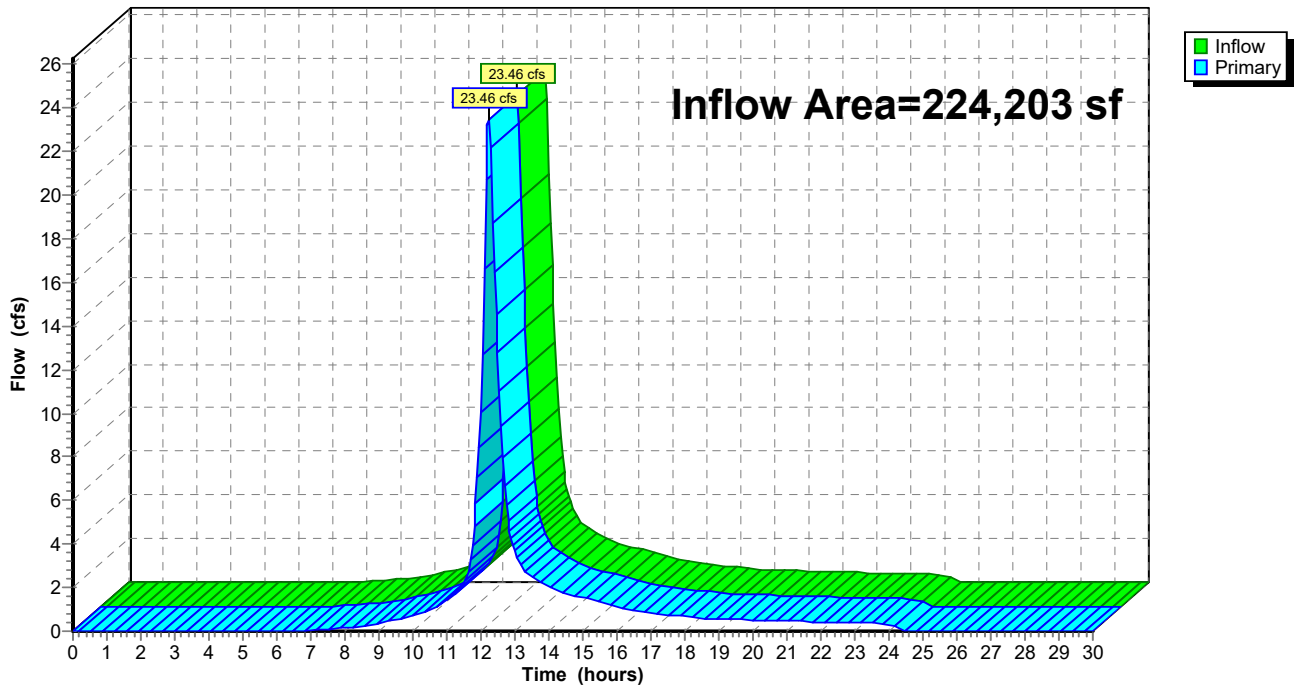

Appendix 2b | HydroCAD Data (Proposed)

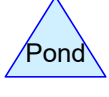
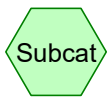
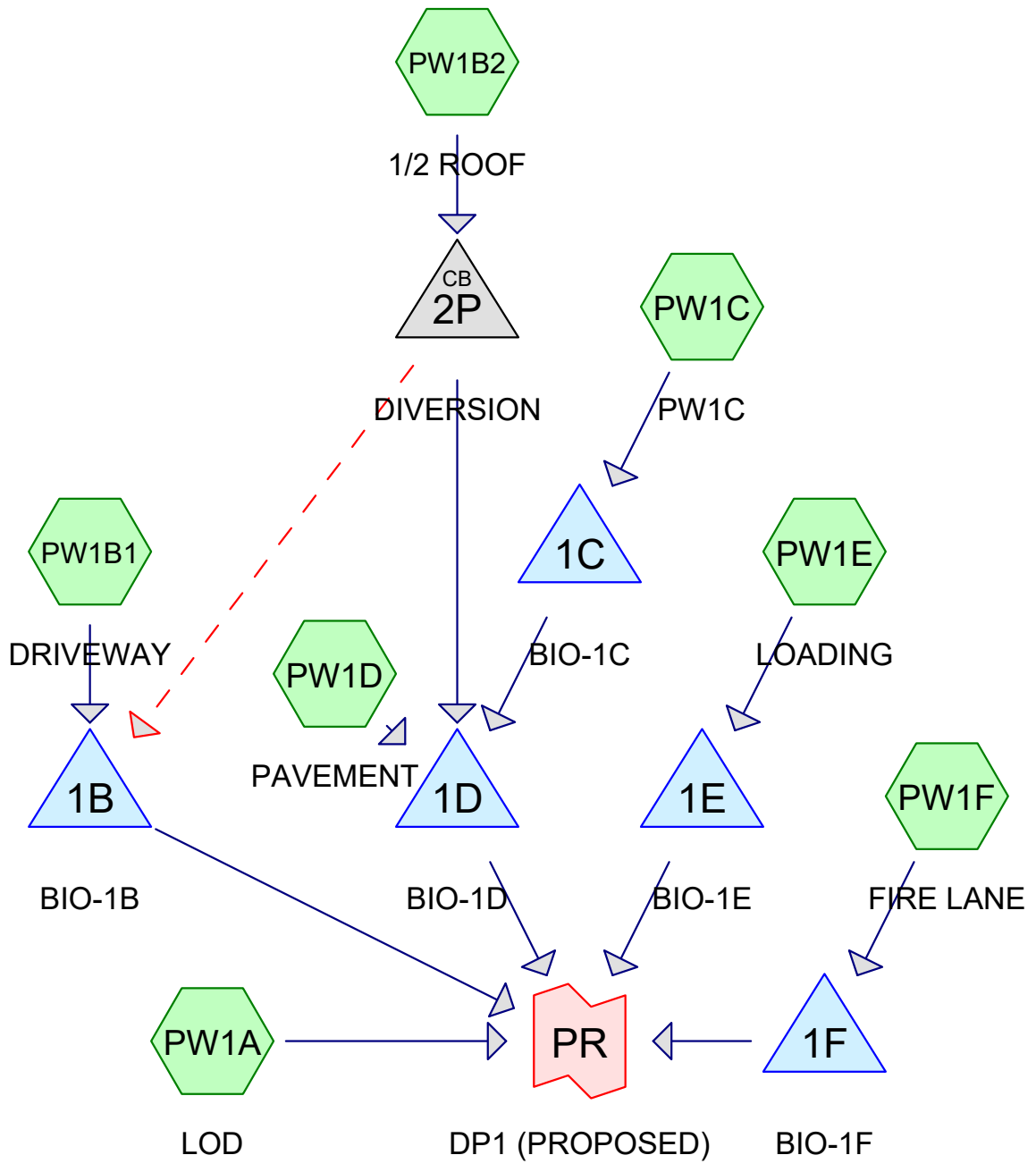

Routing Diagram for 250109 Dewpoint North R3
 Prepared by Colliers Engineering & Design, Printed 1/23/2025
 HydroCAD® 10.20-5c s/n 04431 © 2023 HydroCAD Software Solutions LLC

250109 Dewpoint North R3

Prepared by Colliers Engineering & Design

HydroCAD® 10.20-5c s/n 04431 © 2023 HydroCAD Software Solutions LLC

Printed 1/23/2025

Page 2

Rainfall Events Listing (selected events)

Event#	Event Name	Storm Type	Curve	Mode	Duration (hours)	B/B	Depth (inches)	AMC
1	1-yr	Type III 24-hr		Default	24.00	1	2.64	2
2	10-yr	Type III 24-hr		Default	24.00	1	4.68	2
3	100-yr	Type III 24-hr		Default	24.00	1	8.22	2

250109 Dewpoint North R3

Prepared by Colliers Engineering & Design

HydroCAD® 10.20-5c s/n 04431 © 2023 HydroCAD Software Solutions LLC

Type III 24-hr 1-yr Rainfall=2.64"

Printed 1/23/2025

Page 3

Summary for Subcatchment PW1A: LOD

Runoff = 1.84 cfs @ 12.25 hrs, Volume= 8,307 cf, Depth= 0.88"

Routed to Link PR : DP1 (PROPOSED)

Runoff by SCS TR-20 method, UH=SCS, Weighted-CN, Time Span= 0.00-30.00 hrs, dt= 0.05 hrs
Type III 24-hr 1-yr Rainfall=2.64"

Area (sf)	CN	Description
1,071	98	Paved parking, HSG D
46,678	80	>75% Grass cover, Good, HSG D
2,307	73	Brush, Good, HSG D
63,211	77	Woods, Good, HSG D
113,267	78	Weighted Average
112,196		99.05% Pervious Area
1,071		0.95% Impervious Area

Tc (min)	Length (feet)	Slope (ft/ft)	Velocity (ft/sec)	Capacity (cfs)	Description
16.4	100	0.0400	0.10		Sheet Flow, Woods: Light underbrush n= 0.400 P2= 3.17"

Subcatchment PW1A: LOD

Hydrograph

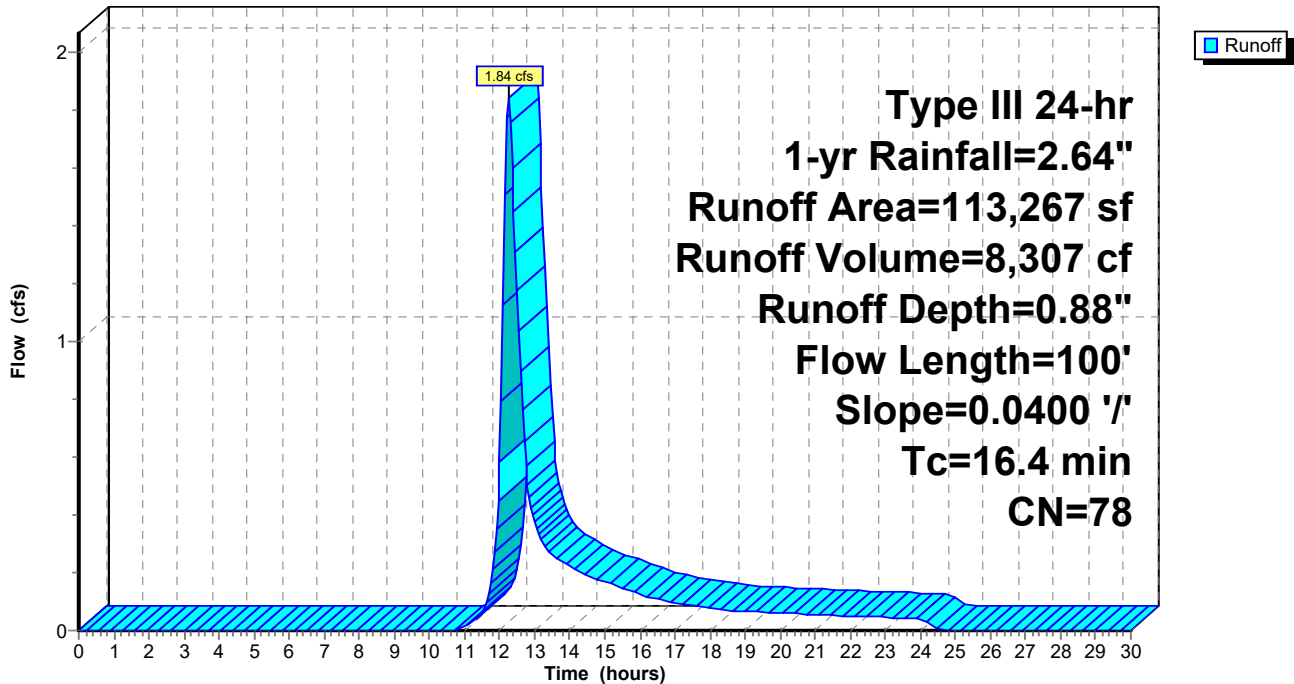

250109 Dewpoint North R3

Prepared by Colliers Engineering & Design

HydroCAD® 10.20-5c s/n 04431 © 2023 HydroCAD Software Solutions LLC

Type III 24-hr 1-yr Rainfall=2.64"

Printed 1/23/2025

Page 4

Summary for Subcatchment PW1B1: DRIVEWAY

Runoff = 1.21 cfs @ 12.09 hrs, Volume= 3,896 cf, Depth= 1.82"
Routed to Pond 1B : BIO-1B

Runoff by SCS TR-20 method, UH=SCS, Weighted-CN, Time Span= 0.00-30.00 hrs, dt= 0.05 hrs
Type III 24-hr 1-yr Rainfall=2.64"

Area (sf)	CN	Description
17,549	98	Paved parking, HSG D
8,097	80	>75% Grass cover, Good, HSG D
25,646	92	Weighted Average
8,097		31.57% Pervious Area
17,549		68.43% Impervious Area

Tc (min)	Length (feet)	Slope (ft/ft)	Velocity (ft/sec)	Capacity (cfs)	Description
6.0					Direct Entry,

Subcatchment PW1B1: DRIVEWAY

Hydrograph

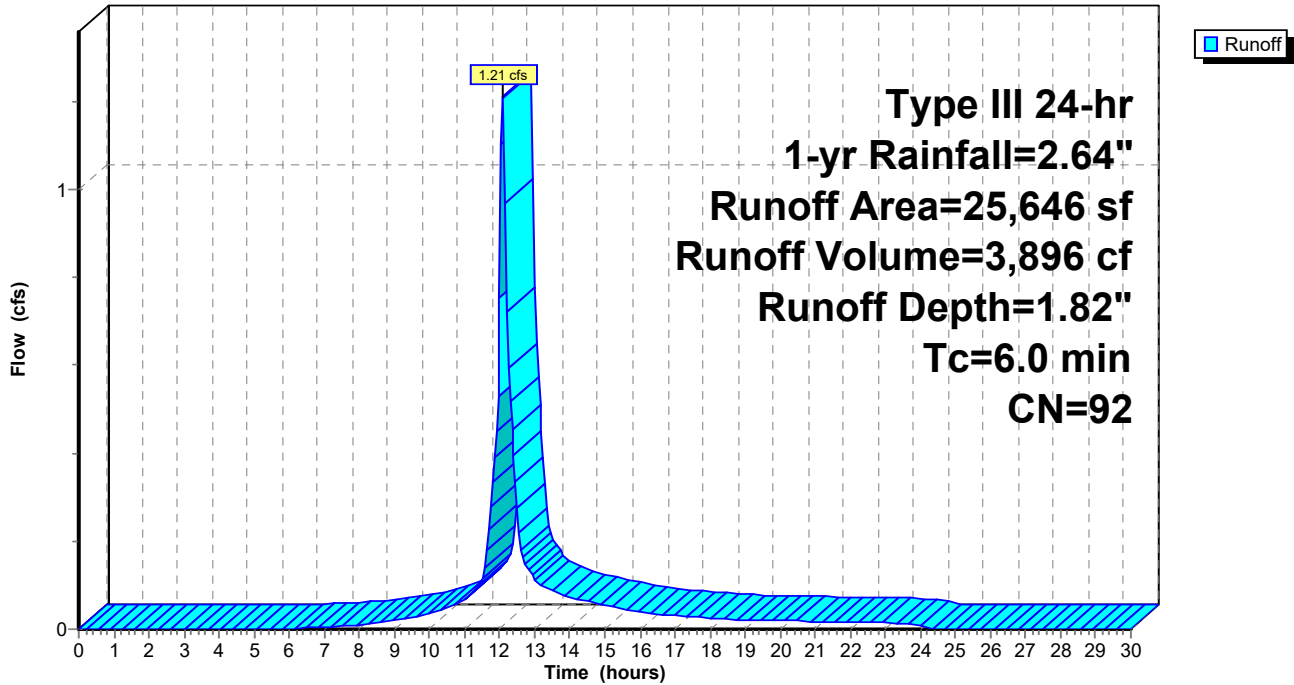

250109 Dewpoint North R3

Prepared by Colliers Engineering & Design

HydroCAD® 10.20-5c s/n 04431 © 2023 HydroCAD Software Solutions LLC

Type III 24-hr 1-yr Rainfall=2.64"

Printed 1/23/2025

Page 5

Summary for Subcatchment PW1B2: 1/2 ROOF

Runoff = 0.91 cfs @ 12.09 hrs, Volume= 3,213 cf, Depth= 2.41"

Routed to Pond 2P : DIVERSION

Runoff by SCS TR-20 method, UH=SCS, Weighted-CN, Time Span= 0.00-30.00 hrs, dt= 0.05 hrs
Type III 24-hr 1-yr Rainfall=2.64"

Area (sf)	CN	Description
* 16,000	98	
16,000		100.00% Impervious Area

Tc (min)	Length (feet)	Slope (ft/ft)	Velocity (ft/sec)	Capacity (cfs)	Description
6.0					Direct Entry,

Subcatchment PW1B2: 1/2 ROOF

Hydrograph

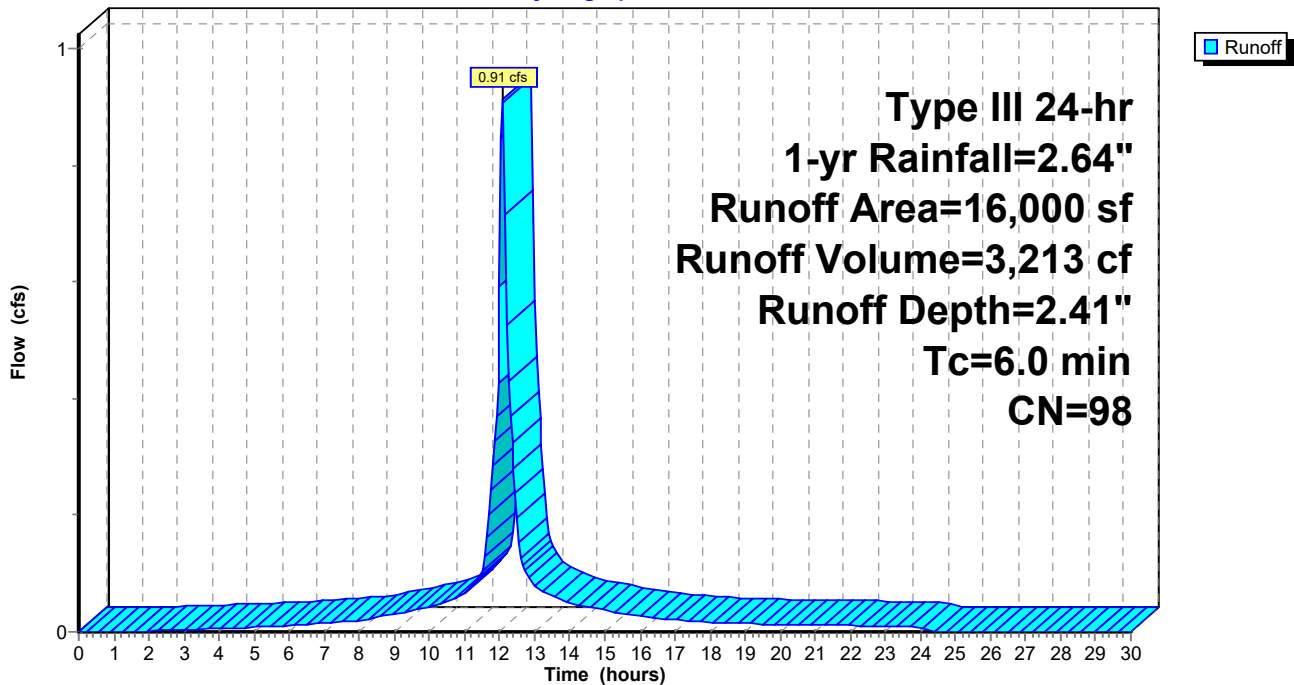

250109 Dewpoint North R3

Prepared by Colliers Engineering & Design

HydroCAD® 10.20-5c s/n 04431 © 2023 HydroCAD Software Solutions LLC

Type III 24-hr 1-yr Rainfall=2.64"

Printed 1/23/2025

Page 6

Summary for Subcatchment PW1C: PW1C

Runoff = 0.66 cfs @ 12.09 hrs, Volume= 2,106 cf, Depth= 1.66"
Routed to Pond 1C : BIO-1C

Runoff by SCS TR-20 method, UH=SCS, Weighted-CN, Time Span= 0.00-30.00 hrs, dt= 0.05 hrs
Type III 24-hr 1-yr Rainfall=2.64"

Area (sf)	CN	Description
8,081	98	Paved parking, HSG D
7,173	80	>75% Grass cover, Good, HSG D
15,254	90	Weighted Average
7,173		47.02% Pervious Area
8,081		52.98% Impervious Area

Tc (min)	Length (feet)	Slope (ft/ft)	Velocity (ft/sec)	Capacity (cfs)	Description
6.0					Direct Entry,

Subcatchment PW1C: PW1C

Hydrograph

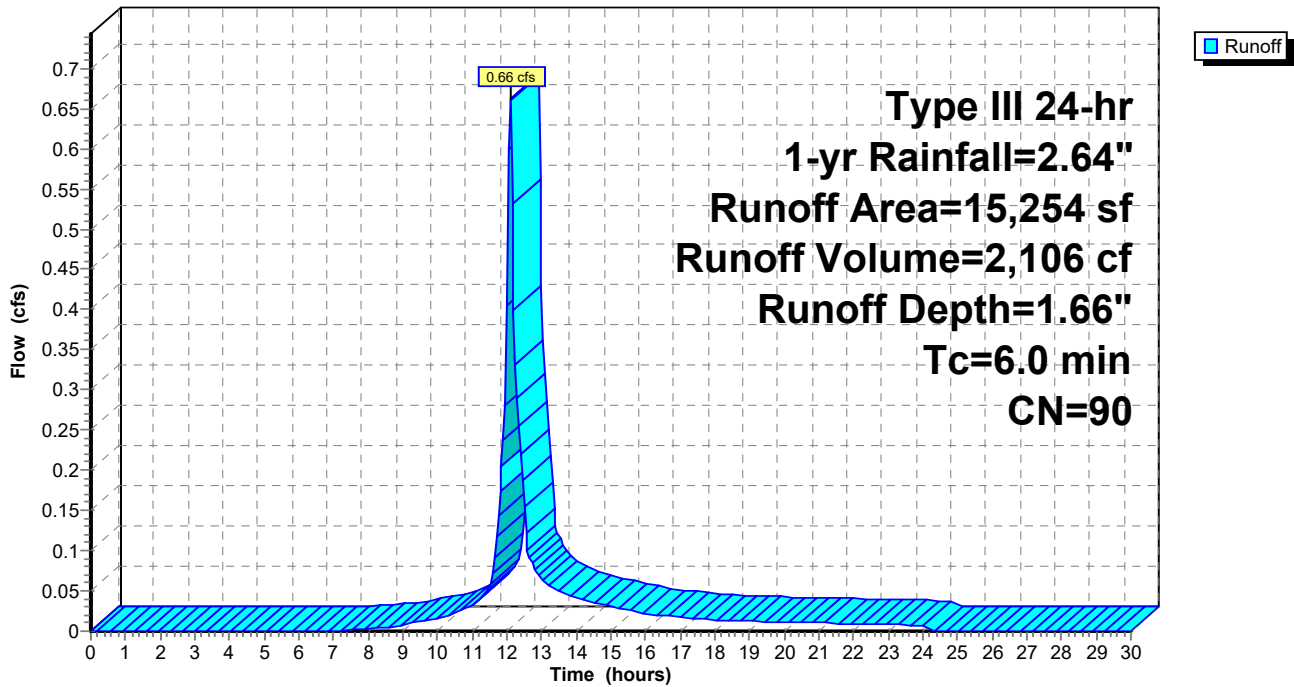

250109 Dewpoint North R3

Prepared by Colliers Engineering & Design

HydroCAD® 10.20-5c s/n 04431 © 2023 HydroCAD Software Solutions LLC

Type III 24-hr 1-yr Rainfall=2.64"

Printed 1/23/2025

Page 7

Summary for Subcatchment PW1D: PAVEMENT

Runoff = 2.06 cfs @ 12.09 hrs, Volume= 6,738 cf, Depth= 2.00"
Routed to Pond 1D : BIO-1D

Runoff by SCS TR-20 method, UH=SCS, Weighted-CN, Time Span= 0.00-30.00 hrs, dt= 0.05 hrs
Type III 24-hr 1-yr Rainfall=2.64"

Area (sf)	CN	Description
30,875	98	Paved parking, HSG D
9,484	80	>75% Grass cover, Good, HSG D
40,359	94	Weighted Average
9,484		23.50% Pervious Area
30,875		76.50% Impervious Area

Tc (min)	Length (feet)	Slope (ft/ft)	Velocity (ft/sec)	Capacity (cfs)	Description
6.0					Direct Entry,

Subcatchment PW1D: PAVEMENT

Hydrograph

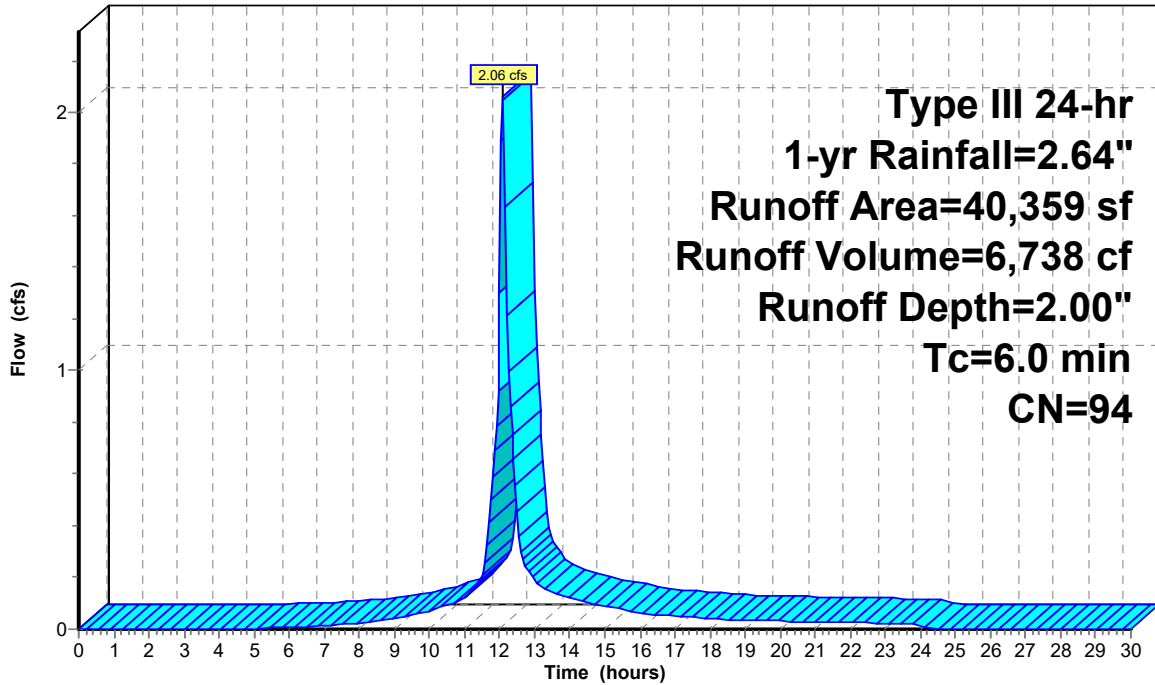

Runoff

250109 Dewpoint North R3

Prepared by Colliers Engineering & Design

HydroCAD® 10.20-5c s/n 04431 © 2023 HydroCAD Software Solutions LLC

Type III 24-hr 1-yr Rainfall=2.64"

Printed 1/23/2025

Page 8

Summary for Subcatchment PW1E: LOADING

Runoff = 0.40 cfs @ 12.09 hrs, Volume= 1,275 cf, Depth= 1.66"
 Routed to Pond 1E : BIO-1E

Runoff by SCS TR-20 method, UH=SCS, Weighted-CN, Time Span= 0.00-30.00 hrs, dt= 0.05 hrs
 Type III 24-hr 1-yr Rainfall=2.64"

Area (sf)	CN	Description
5,385	98	Paved parking, HSG D
3,851	80	>75% Grass cover, Good, HSG D
9,236	90	Weighted Average
3,851		41.70% Pervious Area
5,385		58.30% Impervious Area

Tc (min)	Length (feet)	Slope (ft/ft)	Velocity (ft/sec)	Capacity (cfs)	Description
6.0					Direct Entry,

Subcatchment PW1E: LOADING

Hydrograph

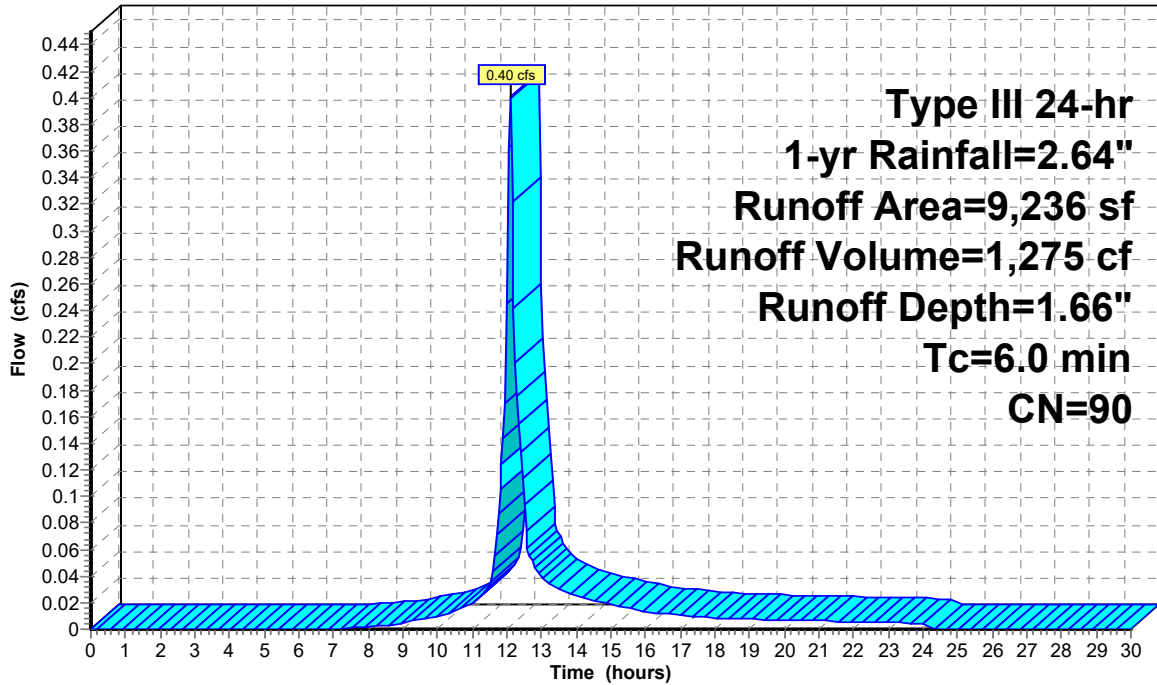

Runoff

250109 Dewpoint North R3

Prepared by Colliers Engineering & Design

HydroCAD® 10.20-5c s/n 04431 © 2023 HydroCAD Software Solutions LLC

Type III 24-hr 1-yr Rainfall=2.64"

Printed 1/23/2025

Page 9

Summary for Subcatchment PW1F: FIRE LANE

Runoff = 0.22 cfs @ 12.09 hrs, Volume= 723 cf, Depth= 1.91"
 Routed to Pond 1F : BIO-1F

Runoff by SCS TR-20 method, UH=SCS, Weighted-CN, Time Span= 0.00-30.00 hrs, dt= 0.05 hrs
 Type III 24-hr 1-yr Rainfall=2.64"

Area (sf)	CN	Description
3,269	98	Paved parking, HSG D
1,268	80	>75% Grass cover, Good, HSG D
4,537	93	Weighted Average
1,268		27.95% Pervious Area
3,269		72.05% Impervious Area

Tc (min)	Length (feet)	Slope (ft/ft)	Velocity (ft/sec)	Capacity (cfs)	Description
6.0					Direct Entry,

Subcatchment PW1F: FIRE LANE

Hydrograph

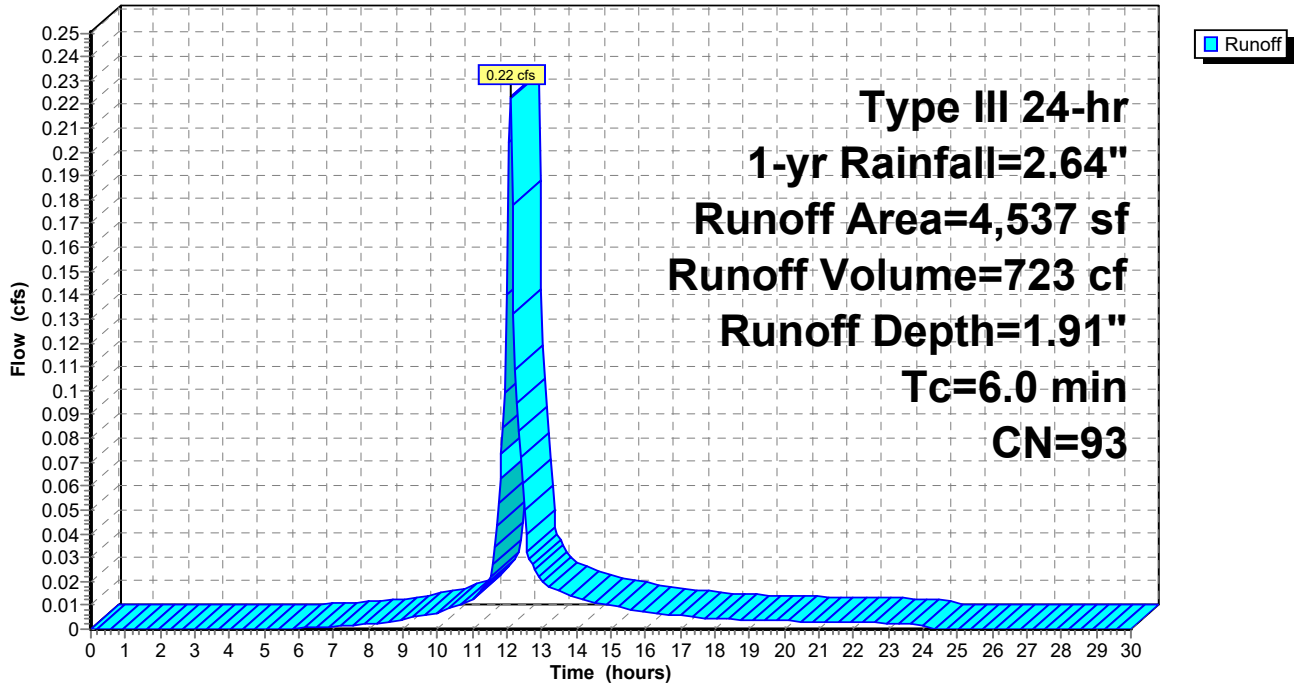

250109 Dewpoint North R3

Type III 24-hr 1-yr Rainfall=2.64"

Prepared by Colliers Engineering & Design

Printed 1/23/2025

HydroCAD® 10.20-5c s/n 04431 © 2023 HydroCAD Software Solutions LLC

Page 10

Summary for Pond 1B: BIO-1B

Inflow Area = 25,646 sf, 68.43% Impervious, Inflow Depth = 1.82" for 1-yr event
 Inflow = 1.21 cfs @ 12.09 hrs, Volume= 3,896 cf
 Outflow = 0.27 cfs @ 12.51 hrs, Volume= 3,663 cf, Atten= 78%, Lag= 24.9 min
 Primary = 0.27 cfs @ 12.51 hrs, Volume= 3,663 cf
 Routed to Link PR : DP1 (PROPOSED)

Routing by Dyn-Stor-Ind method, Time Span= 0.00-30.00 hrs, dt= 0.05 hrs
 Peak Elev= 474.74' @ 12.51 hrs Surf.Area= 2,438 sf Storage= 1,653 cf

Plug-Flow detention time= (not calculated: outflow precedes inflow)
 Center-of-Mass det. time= 131.7 min (936.6 - 804.9)

Volume	Invert	Avail.Storage	Storage Description
#1	474.00'	12,985 cf	Custom Stage Data (Pyramidal) listed below (Recalc)

Elevation (feet)	Surf.Area (sq-ft)	Inc.Store (cubic-feet)	Cum.Store (cubic-feet)	Wet.Area (sq-ft)
474.00	2,038	0	0	2,038
478.00	4,629	12,985	12,985	4,783

Device	Routing	Invert	Outlet Devices
#1	Device 4	477.60'	16.0' long x 0.5' breadth Broad-Crested Rectangular Weir Head (feet) 0.20 0.40 0.60 0.80 1.00 Coef. (English) 2.80 2.92 3.08 3.30 3.32
#2	Device 4	474.20'	4.0" Vert. Orifice/Grate C= 0.600 Limited to weir flow at low heads
#3	Device 4	474.00'	0.250 in/hr BIO MEDIA over Surface area
#4	Primary	470.50'	18.0" Round Culvert L= 17.8' CMP, square edge headwall, Ke= 0.500 Inlet / Outlet Invert= 470.50' / 470.14' S= 0.0202 '/' Cc= 0.900 n= 0.013 Corrugated PE, smooth interior, Flow Area= 1.77 sf

Primary OutFlow Max=0.27 cfs @ 12.51 hrs HW=474.74' TW=0.00' (Dynamic Tailwater)

- ↑ **4=Culvert** (Passes 0.27 cfs of 15.89 cfs potential flow)
- ↑ **1=Broad-Crested Rectangular Weir** (Controls 0.00 cfs)
- ↑ **2=Orifice/Grate** (Orifice Controls 0.26 cfs @ 2.94 fps)
- ↑ **3=BIO MEDIA** (Exfiltration Controls 0.01 cfs)

Pond 1B: BIO-1B

Hydrograph

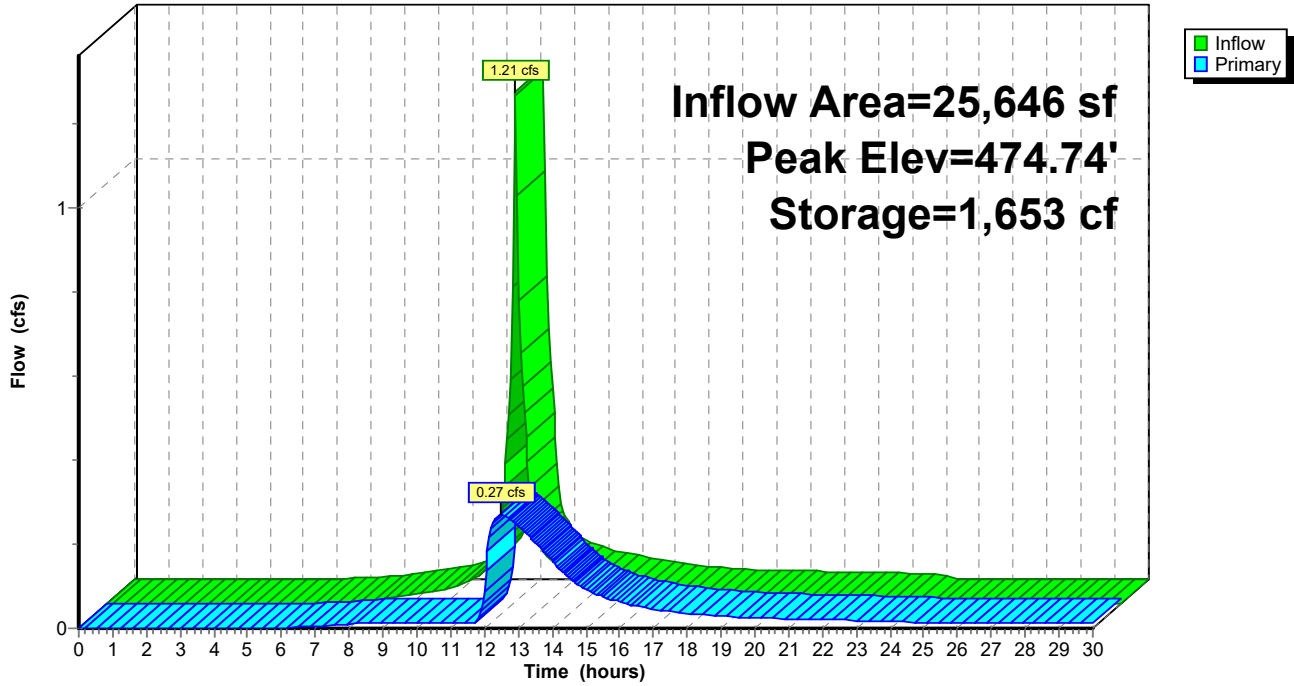

250109 Dewpoint North R3

Prepared by Colliers Engineering & Design

HydroCAD® 10.20-5c s/n 04431 © 2023 HydroCAD Software Solutions LLC

Type III 24-hr 1-yr Rainfall=2.64"

Printed 1/23/2025

Page 12

Stage-Area-Storage for Pond 1B: BIO-1B

Elevation (feet)	Surface (sq-ft)	Storage (cubic-feet)	Elevation (feet)	Surface (sq-ft)	Storage (cubic-feet)
474.00	2,038	0	476.60	3,603	7,237
474.05	2,064	103	476.65	3,637	7,418
474.10	2,090	206	476.70	3,672	7,601
474.15	2,116	312	476.75	3,707	7,785
474.20	2,143	418	476.80	3,742	7,972
474.25	2,169	526	476.85	3,777	8,160
474.30	2,196	635	476.90	3,812	8,349
474.35	2,223	745	476.95	3,847	8,541
474.40	2,250	857	477.00	3,883	8,734
474.45	2,277	970	477.05	3,919	8,929
474.50	2,305	1,085	477.10	3,955	9,126
474.55	2,332	1,201	477.15	3,991	9,325
474.60	2,360	1,318	477.20	4,027	9,525
474.65	2,388	1,437	477.25	4,063	9,727
474.70	2,416	1,557	477.30	4,100	9,931
474.75	2,444	1,678	477.35	4,137	10,137
474.80	2,472	1,801	477.40	4,174	10,345
474.85	2,501	1,926	477.45	4,211	10,555
474.90	2,530	2,051	477.50	4,248	10,766
474.95	2,558	2,179	477.55	4,285	10,979
475.00	2,587	2,307	477.60	4,323	11,195
475.05	2,617	2,437	477.65	4,360	11,412
475.10	2,646	2,569	477.70	4,398	11,631
475.15	2,676	2,702	477.75	4,436	11,852
475.20	2,705	2,837	477.80	4,475	12,074
475.25	2,735	2,973	477.85	4,513	12,299
475.30	2,765	3,110	477.90	4,551	12,526
475.35	2,795	3,249	477.95	4,590	12,754
475.40	2,826	3,390	478.00	4,629	12,985
475.45	2,856	3,532			
475.50	2,887	3,675			
475.55	2,918	3,820			
475.60	2,949	3,967			
475.65	2,980	4,115			
475.70	3,011	4,265			
475.75	3,043	4,416			
475.80	3,074	4,569			
475.85	3,106	4,724			
475.90	3,138	4,880			
475.95	3,170	5,037			
476.00	3,202	5,197			
476.05	3,235	5,358			
476.10	3,268	5,520			
476.15	3,300	5,685			
476.20	3,333	5,850			
476.25	3,366	6,018			
476.30	3,400	6,187			
476.35	3,433	6,358			
476.40	3,467	6,530			
476.45	3,501	6,705			
476.50	3,535	6,880			
476.55	3,569	7,058			

250109 Dewpoint North R3

Type III 24-hr 1-yr Rainfall=2.64"

Prepared by Colliers Engineering & Design

Printed 1/23/2025

HydroCAD® 10.20-5c s/n 04431 © 2023 HydroCAD Software Solutions LLC

Page 13

Summary for Pond 1C: BIO-1C

Inflow Area = 15,254 sf, 52.98% Impervious, Inflow Depth = 1.66" for 1-yr event
 Inflow = 0.66 cfs @ 12.09 hrs, Volume= 2,106 cf
 Outflow = 0.61 cfs @ 12.13 hrs, Volume= 1,860 cf, Atten= 9%, Lag= 2.4 min
 Primary = 0.61 cfs @ 12.13 hrs, Volume= 1,860 cf
 Routed to Pond 1D : BIO-1D

Routing by Dyn-Stor-Ind method, Time Span= 0.00-30.00 hrs, dt= 0.05 hrs
 Peak Elev= 495.36' @ 12.13 hrs Surf.Area= 1,537 sf Storage= 519 cf

Plug-Flow detention time= 165.8 min calculated for 1,857 cf (88% of inflow)
 Center-of-Mass det. time= 112.4 min (926.9 - 814.5)

Volume	Invert	Avail.Storage	Storage Description		
#1	495.00'	2,593 cf	Custom Stage Data (Pyramidal) listed below (Recalc)		
Elevation (feet)	Surf.Area (sq-ft)	Inc.Store (cubic-feet)	Cum.Store (cubic-feet)	Wet.Area (sq-ft)	
495.00	1,379	0	0	1,379	
496.50	2,104	2,593	2,593	2,146	

Device	Routing	Invert	Outlet Devices					
#1	Device 3	495.30'	16.0' long x 0.5' breadth Broad-Crested Rectangular Weir					
			Head (feet) 0.20 0.40 0.60 0.80 1.00					
			Coef. (English) 2.80 2.92 3.08 3.30 3.32					
#2	Device 3	495.00'	0.250 in/hr BIO MEDIA over Surface area					
#3	Primary	491.50'	18.0" Round Culvert L= 82.0' Ke= 0.500					
			Inlet / Outlet Invert= 491.50' / 479.00' S= 0.1524 '/' Cc= 0.900					
			n= 0.013 Corrugated PE, smooth interior, Flow Area= 1.77 sf					

Primary OutFlow Max=0.59 cfs @ 12.13 hrs HW=495.36' TW=479.55' (Dynamic Tailwater)
 3=Culvert (Passes 0.59 cfs of 14.99 cfs potential flow)
 1=Broad-Crested Rectangular Weir (Weir Controls 0.58 cfs @ 0.66 fps)
 2=BIO MEDIA (Exfiltration Controls 0.01 cfs)

Pond 1C: BIO-1C

Hydrograph

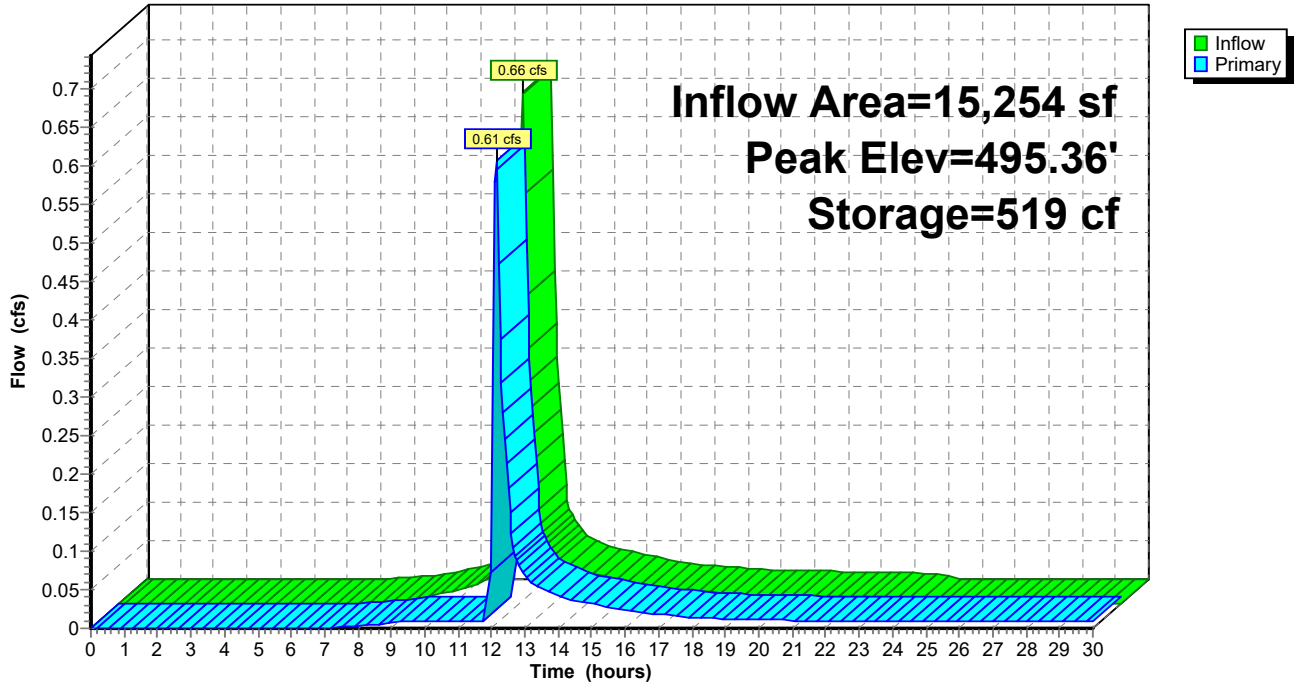

250109 Dewpoint North R3

Type III 24-hr 1-yr Rainfall=2.64"

Prepared by Colliers Engineering & Design

Printed 1/23/2025

HydroCAD® 10.20-5c s/n 04431 © 2023 HydroCAD Software Solutions LLC

Page 15

Stage-Area-Storage for Pond 1C: BIO-1C

Elevation (feet)	Surface (sq-ft)	Storage (cubic-feet)	Elevation (feet)	Surface (sq-ft)	Storage (cubic-feet)
495.00	1,379	0	496.04	1,865	1,681
495.02	1,388	28	496.06	1,876	1,718
495.04	1,396	56	496.08	1,886	1,756
495.06	1,405	84	496.10	1,896	1,794
495.08	1,414	112	496.12	1,906	1,832
495.10	1,423	140	496.14	1,916	1,870
495.12	1,431	169	496.16	1,926	1,908
495.14	1,440	197	496.18	1,937	1,947
495.16	1,449	226	496.20	1,947	1,986
495.18	1,458	255	496.22	1,957	2,025
495.20	1,467	285	496.24	1,967	2,064
495.22	1,476	314	496.26	1,978	2,103
495.24	1,485	344	496.28	1,988	2,143
495.26	1,494	373	496.30	1,999	2,183
495.28	1,503	403	496.32	2,009	2,223
495.30	1,512	433	496.34	2,019	2,263
495.32	1,521	464	496.36	2,030	2,304
495.34	1,530	494	496.38	2,040	2,345
495.36	1,539	525	496.40	2,051	2,385
495.38	1,548	556	496.42	2,061	2,427
495.40	1,557	587	496.44	2,072	2,468
495.42	1,567	618	496.46	2,083	2,509
495.44	1,576	650	496.48	2,093	2,551
495.46	1,585	681	496.50	2,104	2,593
495.48	1,594	713			
495.50	1,604	745			
495.52	1,613	777			
495.54	1,622	809			
495.56	1,632	842			
495.58	1,641	875			
495.60	1,651	908			
495.62	1,660	941			
495.64	1,670	974			
495.66	1,679	1,008			
495.68	1,689	1,041			
495.70	1,698	1,075			
495.72	1,708	1,109			
495.74	1,718	1,143			
495.76	1,727	1,178			
495.78	1,737	1,213			
495.80	1,747	1,247			
495.82	1,756	1,282			
495.84	1,766	1,318			
495.86	1,776	1,353			
495.88	1,786	1,389			
495.90	1,796	1,424			
495.92	1,806	1,461			
495.94	1,815	1,497			
495.96	1,825	1,533			
495.98	1,835	1,570			
496.00	1,845	1,607			
496.02	1,855	1,644			

250109 Dewpoint North R3

Type III 24-hr 1-yr Rainfall=2.64"

Prepared by Colliers Engineering & Design

Printed 1/23/2025

HydroCAD® 10.20-5c s/n 04431 © 2023 HydroCAD Software Solutions LLC

Page 16

Summary for Pond 1D: BIO-1D

Inflow Area = 71,613 sf, 76.74% Impervious, Inflow Depth > 1.98" for 1-yr event
 Inflow = 3.53 cfs @ 12.10 hrs, Volume= 11,811 cf
 Outflow = 0.17 cfs @ 14.88 hrs, Volume= 5,358 cf, Atten= 95%, Lag= 166.9 min
 Primary = 0.17 cfs @ 14.88 hrs, Volume= 5,358 cf
 Routed to Link PR : DP1 (PROPOSED)

Routing by Dyn-Stor-Ind method, Time Span= 0.00-30.00 hrs, dt= 0.05 hrs
 Peak Elev= 480.05' @ 14.88 hrs Surf.Area= 7,486 sf Storage= 7,575 cf

Plug-Flow detention time= 385.9 min calculated for 5,358 cf (45% of inflow)
 Center-of-Mass det. time= 248.7 min (1,054.3 - 805.6)

Volume	Invert	Avail.Storage	Storage Description		
#1	479.00'	23,267 cf	Custom Stage Data (Pyramidal) Listed below (Recalc)		
Elevation (feet)	Surf.Area (sq-ft)	Inc.Store (cubic-feet)	Cum.Store (cubic-feet)	Wet.Area (sq-ft)	
479.00	6,887	0	0	6,887	
482.00	8,658	23,267	23,267	8,949	

Device	Routing	Invert	Outlet Devices
#1	Device 3	480.75'	16.0' long x 0.5' breadth Broad-Crested Rectangular Weir Head (feet) 0.20 0.40 0.60 0.80 1.00 Coef. (English) 2.80 2.92 3.08 3.30 3.32
#2	Device 3	479.00'	0.250 in/hr BIO MEDIA over Surface area
#3	Primary	475.50'	18.0" Round Culvert L= 22.6' CMP, square edge headwall, Ke= 0.500 Inlet / Outlet Invert= 475.50' / 474.80' S= 0.0310 '/' Cc= 0.900 n= 0.013 Corrugated PE, smooth interior, Flow Area= 1.77 sf
#4	Primary	480.00'	36.0" W x 4.0" H Vert. Orifice/Grate C= 0.600 Limited to weir flow at low heads

Primary OutFlow Max=0.17 cfs @ 14.88 hrs HW=480.05' TW=0.00' (Dynamic Tailwater)

- 3=Culvert (Passes 0.04 cfs of 16.60 cfs potential flow)
- 1=Broad-Crested Rectangular Weir (Controls 0.00 cfs)
- 2=BIO MEDIA (Exfiltration Controls 0.04 cfs)
- 4=Orifice/Grate (Orifice Controls 0.12 cfs @ 0.75 fps)

Pond 1D: BIO-1D

Hydrograph

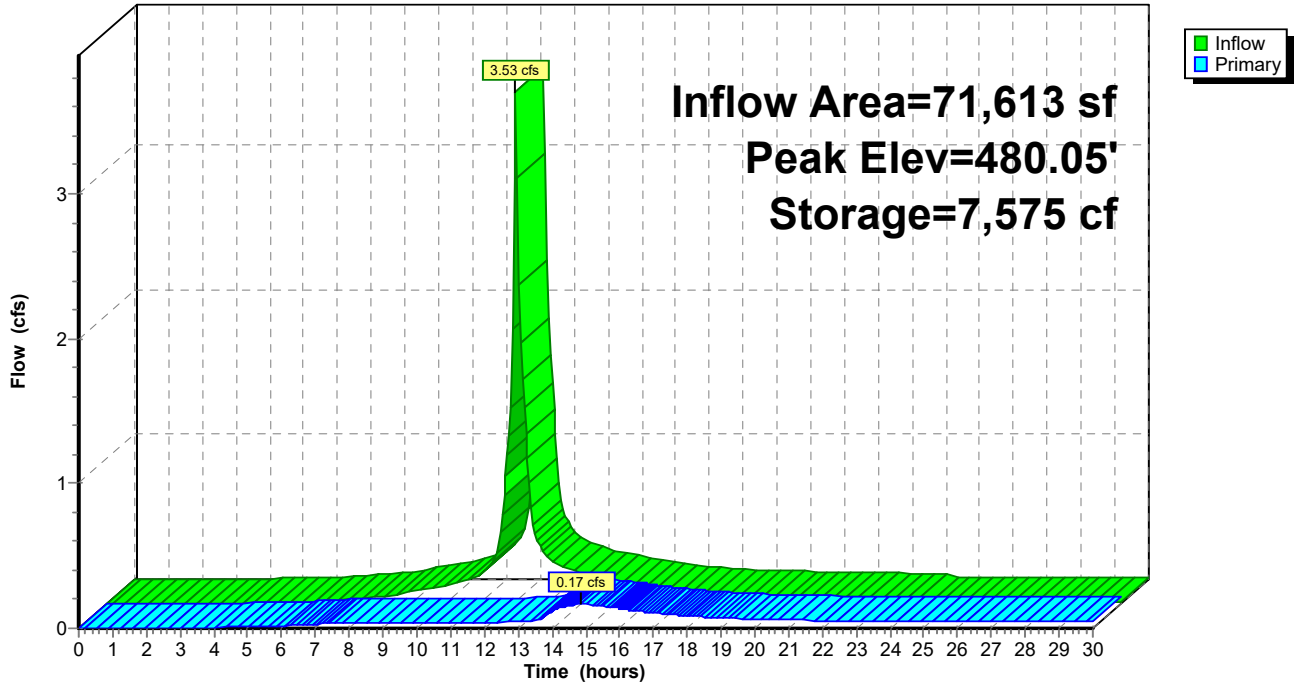

250109 Dewpoint North R3

Type III 24-hr 1-yr Rainfall=2.64"

Prepared by Colliers Engineering & Design

Printed 1/23/2025

HydroCAD® 10.20-5c s/n 04431 © 2023 HydroCAD Software Solutions LLC

Page 18

Stage-Area-Storage for Pond 1D: BIO-1D

Elevation (feet)	Surface (sq-ft)	Storage (cubic-feet)	Elevation (feet)	Surface (sq-ft)	Storage (cubic-feet)
479.00	6,887	0	481.60	8,410	19,853
479.05	6,915	345	481.65	8,441	20,275
479.10	6,943	691	481.70	8,472	20,697
479.15	6,971	1,039	481.75	8,503	21,122
479.20	6,999	1,389	481.80	8,534	21,548
479.25	7,027	1,739	481.85	8,565	21,975
479.30	7,055	2,091	481.90	8,596	22,404
479.35	7,083	2,445	481.95	8,627	22,835
479.40	7,111	2,800	482.00	8,658	23,267
479.45	7,140	3,156			
479.50	7,168	3,514			
479.55	7,197	3,873			
479.60	7,225	4,233			
479.65	7,254	4,595			
479.70	7,282	4,959			
479.75	7,311	5,323			
479.80	7,339	5,690			
479.85	7,368	6,057			
479.90	7,397	6,426			
479.95	7,426	6,797			
480.00	7,455	7,169			
480.05	7,484	7,543			
480.10	7,513	7,917			
480.15	7,542	8,294			
480.20	7,571	8,672			
480.25	7,600	9,051			
480.30	7,630	9,432			
480.35	7,659	9,814			
480.40	7,688	10,198			
480.45	7,718	10,583			
480.50	7,747	10,969			
480.55	7,777	11,357			
480.60	7,806	11,747			
480.65	7,836	12,138			
480.70	7,866	12,531			
480.75	7,895	12,925			
480.80	7,925	13,320			
480.85	7,955	13,717			
480.90	7,985	14,116			
480.95	8,015	14,516			
481.00	8,045	14,917			
481.05	8,075	15,320			
481.10	8,105	15,725			
481.15	8,136	16,131			
481.20	8,166	16,538			
481.25	8,196	16,947			
481.30	8,227	17,358			
481.35	8,257	17,770			
481.40	8,288	18,184			
481.45	8,318	18,599			
481.50	8,349	19,015			
481.55	8,379	19,434			

250109 Dewpoint North R3

Type III 24-hr 1-yr Rainfall=2.64"

Prepared by Colliers Engineering & Design

Printed 1/23/2025

HydroCAD® 10.20-5c s/n 04431 © 2023 HydroCAD Software Solutions LLC

Page 19

Summary for Pond 1E: BIO-1E

Inflow Area = 9,236 sf, 58.30% Impervious, Inflow Depth = 1.66" for 1-yr event
 Inflow = 0.40 cfs @ 12.09 hrs, Volume= 1,275 cf
 Outflow = 0.01 cfs @ 17.10 hrs, Volume= 518 cf, Atten= 97%, Lag= 300.6 min
 Primary = 0.01 cfs @ 17.10 hrs, Volume= 518 cf
 Routed to Link PR : DP1 (PROPOSED)

Routing by Dyn-Stor-Ind method, Time Span= 0.00-30.00 hrs, dt= 0.05 hrs
 Peak Elev= 490.04' @ 17.10 hrs Surf.Area= 1,070 sf Storage= 921 cf

Plug-Flow detention time= (not calculated: outflow precedes inflow)
 Center-of-Mass det. time= 349.4 min (1,163.9 - 814.5)

Volume	Invert	Avail.Storage	Storage Description		
#1	489.00'	3,828 cf	Custom Stage Data (Pyramidal) listed below (Recalc)		
Elevation (feet)	Surf.Area (sq-ft)	Inc.Store (cubic-feet)	Cum.Store (cubic-feet)	Wet.Area (sq-ft)	
489.00	715	0	0	715	
492.00	1,936	3,828	3,828	2,008	

Device	Routing	Invert	Outlet Devices
#1	Device 4	491.00'	16.0' long x 0.5' breadth Broad-Crested Rectangular Weir Head (feet) 0.20 0.40 0.60 0.80 1.00 Coef. (English) 2.80 2.92 3.08 3.30 3.32
#2	Device 4	490.00'	5.0" Vert. Orifice/Grate C= 0.600 Limited to weir flow at low heads
#3	Device 4	489.00'	0.250 in/hr BIO MEDIA over Surface area
#4	Primary	485.50'	12.0" Round Culvert L= 33.0' CMP, square edge headwall, Ke= 0.500 Inlet / Outlet Invert= 485.50' / 480.00' S= 0.1667 '/' Cc= 0.900 n= 0.013 Corrugated PE, smooth interior, Flow Area= 0.79 sf

Primary OutFlow Max=0.01 cfs @ 17.10 hrs HW=490.04' TW=0.00' (Dynamic Tailwater)

- ↑ **4=Culvert** (Passes 0.01 cfs of 7.60 cfs potential flow)
- ↑ **1=Broad-Crested Rectangular Weir** (Controls 0.00 cfs)
- ↑ **2=Orifice/Grate** (Orifice Controls 0.00 cfs @ 0.67 fps)
- ↑ **3=BIO MEDIA** (Exfiltration Controls 0.01 cfs)

Pond 1E: BIO-1E

Hydrograph

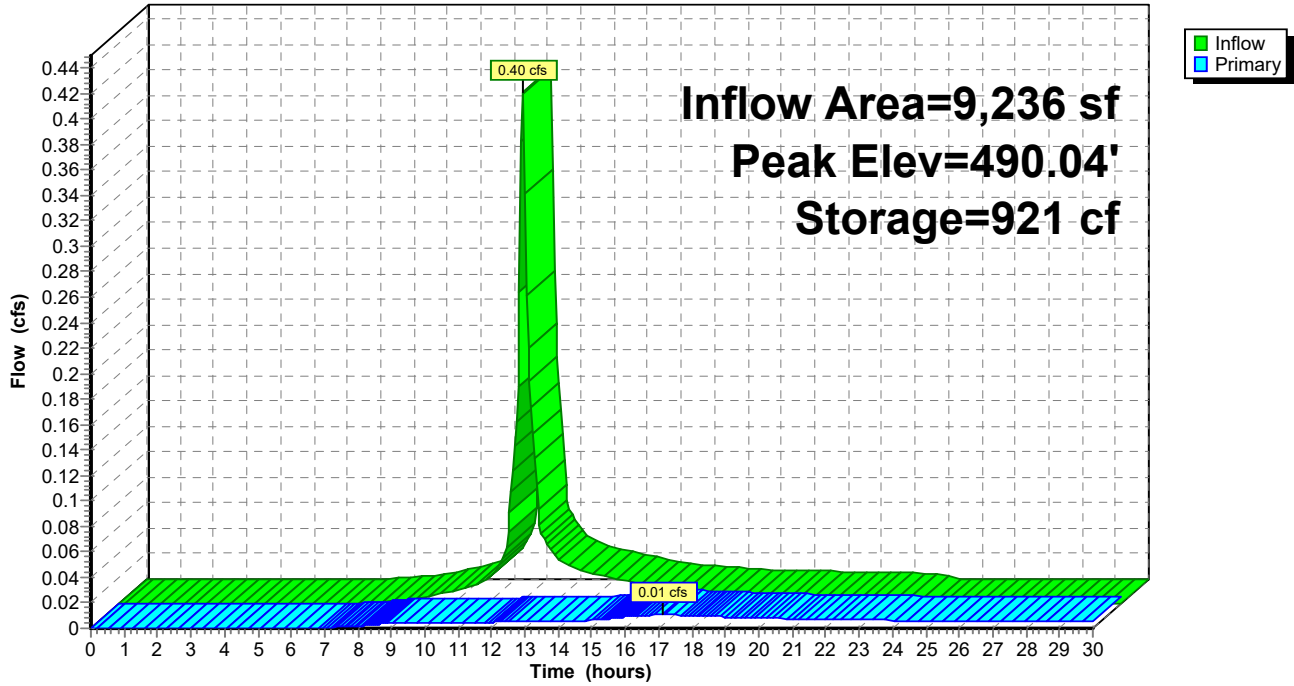

250109 Dewpoint North R3

Prepared by Colliers Engineering & Design

HydroCAD® 10.20-5c s/n 04431 © 2023 HydroCAD Software Solutions LLC

Type III 24-hr 1-yr Rainfall=2.64"

Printed 1/23/2025

Page 21

Stage-Area-Storage for Pond 1E: BIO-1E

Elevation (feet)	Surface (sq-ft)	Storage (cubic-feet)	Elevation (feet)	Surface (sq-ft)	Storage (cubic-feet)
489.00	715	0	491.60	1,739	3,093
489.05	730	36	491.65	1,763	3,180
489.10	746	73	491.70	1,787	3,269
489.15	762	111	491.75	1,811	3,359
489.20	778	149	491.80	1,836	3,450
489.25	794	189	491.85	1,861	3,543
489.30	810	229	491.90	1,886	3,636
489.35	827	270	491.95	1,911	3,731
489.40	843	311	492.00	1,936	3,828
489.45	860	354			
489.50	877	397			
489.55	894	442			
489.60	912	487			
489.65	929	533			
489.70	947	580			
489.75	964	627			
489.80	982	676			
489.85	1,000	726			
489.90	1,019	776			
489.95	1,037	828			
490.00	1,056	880			
490.05	1,075	933			
490.10	1,094	987			
490.15	1,113	1,042			
490.20	1,132	1,099			
490.25	1,151	1,156			
490.30	1,171	1,214			
490.35	1,191	1,273			
490.40	1,211	1,333			
490.45	1,231	1,394			
490.50	1,251	1,456			
490.55	1,271	1,519			
490.60	1,292	1,583			
490.65	1,313	1,648			
490.70	1,334	1,714			
490.75	1,355	1,782			
490.80	1,376	1,850			
490.85	1,398	1,919			
490.90	1,419	1,990			
490.95	1,441	2,061			
491.00	1,463	2,134			
491.05	1,485	2,207			
491.10	1,507	2,282			
491.15	1,530	2,358			
491.20	1,552	2,435			
491.25	1,575	2,513			
491.30	1,598	2,593			
491.35	1,621	2,673			
491.40	1,644	2,755			
491.45	1,668	2,837			
491.50	1,691	2,921			
491.55	1,715	3,007			

250109 Dewpoint North R3

Type III 24-hr 1-yr Rainfall=2.64"

Prepared by Colliers Engineering & Design

Printed 1/23/2025

HydroCAD® 10.20-5c s/n 04431 © 2023 HydroCAD Software Solutions LLC

Page 22

Summary for Pond 1F: BIO-1F

Inflow Area = 4,537 sf, 72.05% Impervious, Inflow Depth = 1.91" for 1-yr event
 Inflow = 0.22 cfs @ 12.09 hrs, Volume= 723 cf
 Outflow = 0.02 cfs @ 13.63 hrs, Volume= 345 cf, Atten= 93%, Lag= 92.4 min
 Primary = 0.02 cfs @ 13.63 hrs, Volume= 345 cf
 Routed to Link PR : DP1 (PROPOSED)

Routing by Dyn-Stor-Ind method, Time Span= 0.00-30.00 hrs, dt= 0.05 hrs
 Peak Elev= 482.01' @ 13.63 hrs Surf.Area= 583 sf Storage= 458 cf

Plug-Flow detention time= (not calculated: outflow precedes inflow)
 Center-of-Mass det. time= 287.8 min (1,087.3 - 799.5)

Volume	Invert	Avail.Storage	Storage Description
#1	481.00'	781 cf	Custom Stage Data (Pyramidal) Listed below (Recalc)
Elevation (feet)	Surf.Area (sq-ft)	Inc.Store (cubic-feet)	Cum.Store (cubic-feet) Wet.Area (sq-ft)
481.00	339	0	0 339
482.50	727	781	781 750

Device	Routing	Invert	Outlet Devices
#1	Primary	482.00'	10.0' long x 10.0' breadth Broad-Crested Rectangular Weir Head (feet) 0.20 0.40 0.60 0.80 1.00 1.20 1.40 1.60 Coef. (English) 2.49 2.56 2.70 2.69 2.68 2.69 2.67 2.64
#2	Primary	481.00'	0.250 in/hr BIO MEDIA over Surface area

Primary OutFlow Max=0.02 cfs @ 13.63 hrs HW=482.01' TW=0.00' (Dynamic Tailwater)
 1=Broad-Crested Rectangular Weir (Weir Controls 0.01 cfs @ 0.20 fps)
 2=BIO MEDIA (Exfiltration Controls 0.00 cfs)

Pond 1F: BIO-1F

Hydrograph

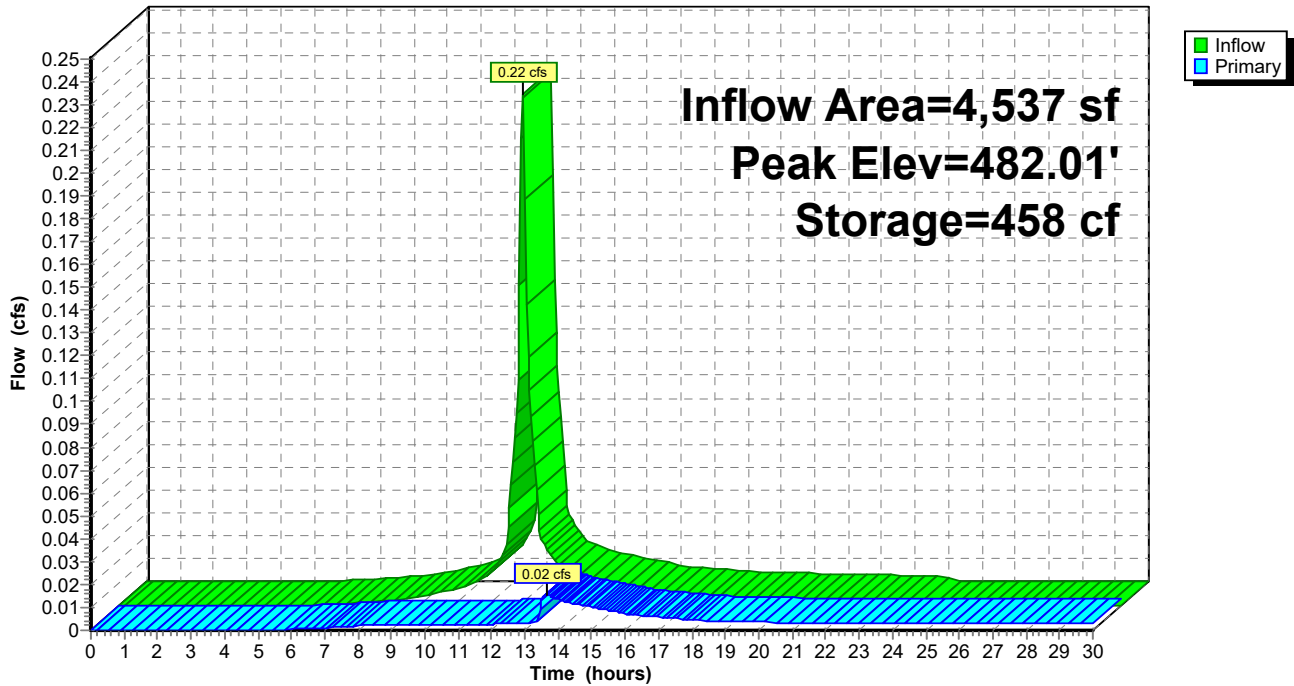

250109 Dewpoint North R3

Prepared by Colliers Engineering & Design

HydroCAD® 10.20-5c s/n 04431 © 2023 HydroCAD Software Solutions LLC

Type III 24-hr 1-yr Rainfall=2.64"

Printed 1/23/2025

Page 24

Stage-Area-Storage for Pond 1F: BIO-1F

Elevation (feet)	Surface (sq-ft)	Storage (cubic-feet)	Elevation (feet)	Surface (sq-ft)	Storage (cubic-feet)
481.00	339	0	482.04	592	478
481.02	343	7	482.06	598	490
481.04	347	14	482.08	604	502
481.06	352	21	482.10	609	514
481.08	356	28	482.12	615	527
481.10	360	35	482.14	621	539
481.12	365	42	482.16	626	551
481.14	369	50	482.18	632	564
481.16	373	57	482.20	638	577
481.18	378	64	482.22	643	589
481.20	382	72	482.24	649	602
481.22	387	80	482.26	655	615
481.24	391	88	482.28	661	629
481.26	396	95	482.30	667	642
481.28	400	103	482.32	673	655
481.30	405	111	482.34	679	669
481.32	410	120	482.36	685	682
481.34	414	128	482.38	691	696
481.36	419	136	482.40	697	710
481.38	423	145	482.42	703	724
481.40	428	153	482.44	709	738
481.42	433	162	482.46	715	752
481.44	438	170	482.48	721	767
481.46	442	179	482.50	727	781
481.48	447	188			
481.50	452	197			
481.52	457	206			
481.54	462	215			
481.56	467	225			
481.58	472	234			
481.60	477	244			
481.62	482	253			
481.64	487	263			
481.66	492	273			
481.68	497	282			
481.70	502	292			
481.72	507	303			
481.74	512	313			
481.76	517	323			
481.78	523	333			
481.80	528	344			
481.82	533	355			
481.84	538	365			
481.86	544	376			
481.88	549	387			
481.90	554	398			
481.92	560	409			
481.94	565	420			
481.96	570	432			
481.98	576	443			
482.00	581	455			
482.02	587	466			

250109 Dewpoint North R3

Prepared by Colliers Engineering & Design

HydroCAD® 10.20-5c s/n 04431 © 2023 HydroCAD Software Solutions LLC

Type III 24-hr 1-yr Rainfall=2.64"

Printed 1/23/2025

Page 25

Summary for Pond 2P: DIVERSION

Inflow Area = 16,000 sf, 100.00% Impervious, Inflow Depth = 2.41" for 1-yr event
 Inflow = 0.91 cfs @ 12.09 hrs, Volume= 3,213 cf
 Outflow = 0.91 cfs @ 12.09 hrs, Volume= 3,213 cf, Atten= 0%, Lag= 0.0 min
 Primary = 0.91 cfs @ 12.09 hrs, Volume= 3,213 cf
 Routed to Pond 1D : BIO-1D
 Secondary = 0.00 cfs @ 0.00 hrs, Volume= 0 cf
 Routed to Pond 1B : BIO-1B

Routing by Dyn-Stor-Ind method, Time Span= 0.00-30.00 hrs, dt= 0.05 hrs
 Peak Elev= 489.18' @ 12.09 hrs

Device	Routing	Invert	Outlet Devices
#1	Primary	488.00'	6.0" Round Culvert L= 12.0' CMP, square edge headwall, Ke= 0.500 Inlet / Outlet Invert= 488.00' / 486.00' S= 0.1667 ' S= 0.1667 ' Cc= 0.900 n= 0.013 Corrugated PE, smooth interior, Flow Area= 0.20 sf
#2	Secondary	489.20'	15.0" Round Culvert L= 250.0' Ke= 0.500 Inlet / Outlet Invert= 489.20' / 470.00' S= 0.0768 ' S= 0.0768 ' Cc= 0.900 n= 0.013 Corrugated PE, smooth interior, Flow Area= 1.23 sf

Primary OutFlow Max=0.89 cfs @ 12.09 hrs HW=489.14' TW=479.47' (Dynamic Tailwater)
 ↳1=Culvert (Inlet Controls 0.89 cfs @ 4.53 fps)

Secondary OutFlow Max=0.00 cfs @ 0.00 hrs HW=488.00' TW=474.00' (Dynamic Tailwater)
 ↳2=Culvert (Controls 0.00 cfs)

Pond 2P: DIVERSION

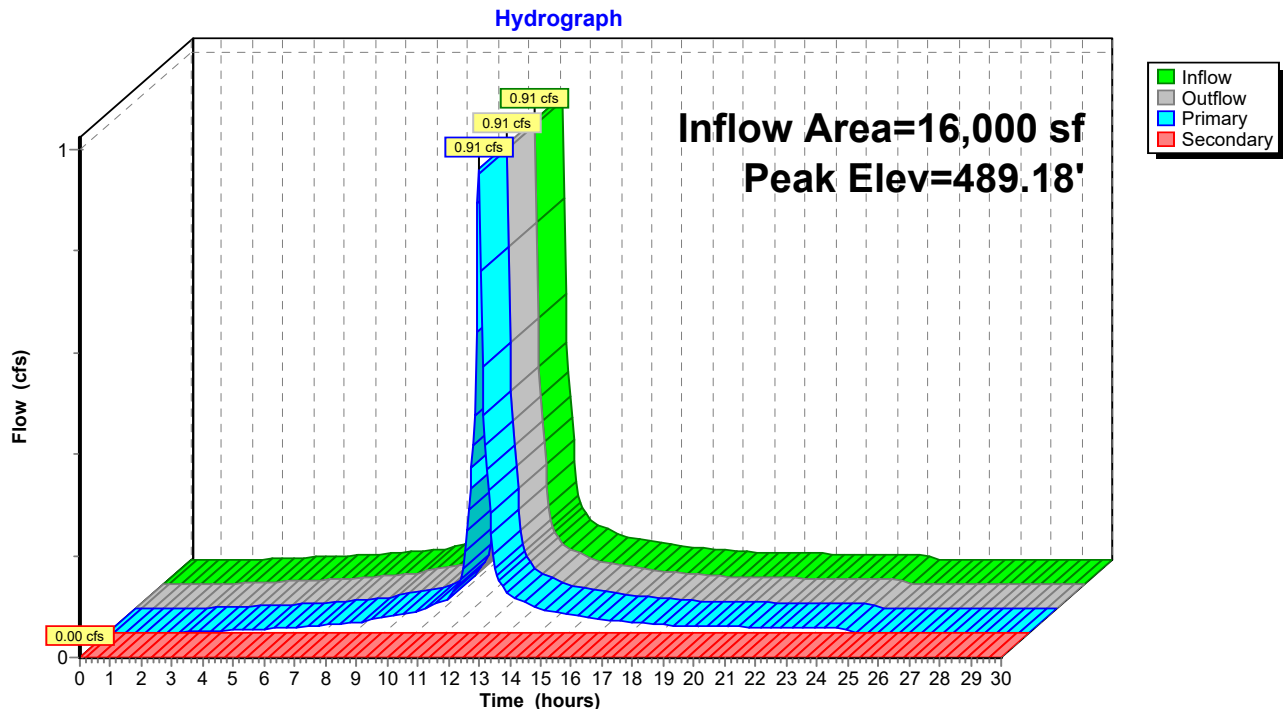

250109 Dewpoint North R3

Type III 24-hr 1-yr Rainfall=2.64"

Prepared by Colliers Engineering & Design

Printed 1/23/2025

HydroCAD® 10.20-5c s/n 04431 © 2023 HydroCAD Software Solutions LLC

Page 26

Stage-Area-Storage for Pond 2P: DIVERSION

Elevation (feet)	Storage (cubic-feet)	Elevation (feet)	Storage (cubic-feet)	Elevation (feet)	Storage (cubic-feet)
488.00	0	489.04	0	490.08	0
488.02	0	489.06	0	490.10	0
488.04	0	489.08	0	490.12	0
488.06	0	489.10	0	490.14	0
488.08	0	489.12	0	490.16	0
488.10	0	489.14	0	490.18	0
488.12	0	489.16	0	490.20	0
488.14	0	489.18	0	490.22	0
488.16	0	489.20	0	490.24	0
488.18	0	489.22	0	490.26	0
488.20	0	489.24	0	490.28	0
488.22	0	489.26	0	490.30	0
488.24	0	489.28	0	490.32	0
488.26	0	489.30	0	490.34	0
488.28	0	489.32	0	490.36	0
488.30	0	489.34	0	490.38	0
488.32	0	489.36	0	490.40	0
488.34	0	489.38	0	490.42	0
488.36	0	489.40	0	490.44	0
488.38	0	489.42	0		
488.40	0	489.44	0		
488.42	0	489.46	0		
488.44	0	489.48	0		
488.46	0	489.50	0		
488.48	0	489.52	0		
488.50	0	489.54	0		
488.52	0	489.56	0		
488.54	0	489.58	0		
488.56	0	489.60	0		
488.58	0	489.62	0		
488.60	0	489.64	0		
488.62	0	489.66	0		
488.64	0	489.68	0		
488.66	0	489.70	0		
488.68	0	489.72	0		
488.70	0	489.74	0		
488.72	0	489.76	0		
488.74	0	489.78	0		
488.76	0	489.80	0		
488.78	0	489.82	0		
488.80	0	489.84	0		
488.82	0	489.86	0		
488.84	0	489.88	0		
488.86	0	489.90	0		
488.88	0	489.92	0		
488.90	0	489.94	0		
488.92	0	489.96	0		
488.94	0	489.98	0		
488.96	0	490.00	0		
488.98	0	490.02	0		
489.00	0	490.04	0		
489.02	0	490.06	0		

250109 Dewpoint North R3

Prepared by Colliers Engineering & Design

HydroCAD® 10.20-5c s/n 04431 © 2023 HydroCAD Software Solutions LLC

Type III 24-hr 1-yr Rainfall=2.64"

Printed 1/23/2025

Page 27

Summary for Link PR: DP1 (PROPOSED)

Inflow Area = 224,299 sf, 36.66% Impervious, Inflow Depth > 0.97" for 1-yr event
Inflow = 2.14 cfs @ 12.25 hrs, Volume= 18,190 cf
Primary = 2.14 cfs @ 12.25 hrs, Volume= 18,190 cf, Atten= 0%, Lag= 0.0 min

Primary outflow = Inflow, Time Span= 0.00-30.00 hrs, dt= 0.05 hrs

Link PR: DP1 (PROPOSED)

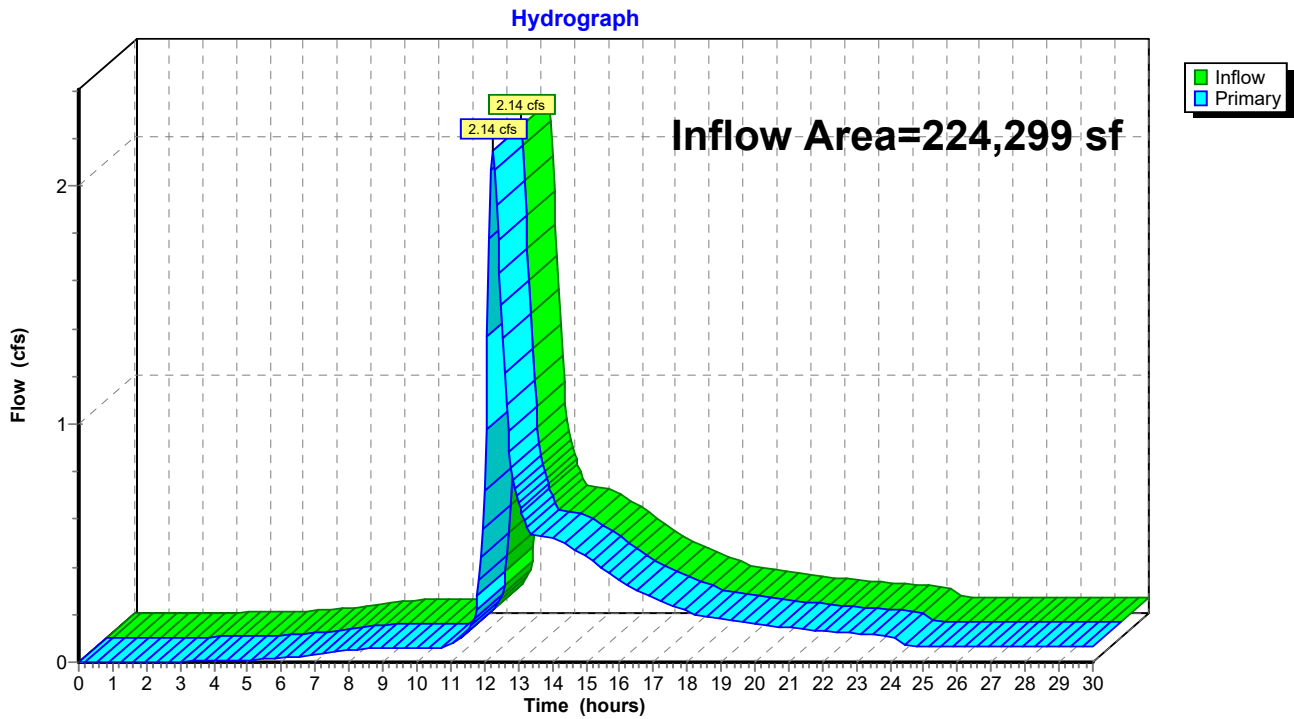

250109 Dewpoint North R3

Prepared by Colliers Engineering & Design

HydroCAD® 10.20-5c s/n 04431 © 2023 HydroCAD Software Solutions LLC

Type III 24-hr 10-yr Rainfall=4.68"

Printed 1/23/2025

Page 28

Summary for Subcatchment PW1A: LOD

Runoff = 5.40 cfs @ 12.23 hrs, Volume= 23,052 cf, Depth= 2.44"

Routed to Link PR : DP1 (PROPOSED)

Runoff by SCS TR-20 method, UH=SCS, Weighted-CN, Time Span= 0.00-30.00 hrs, dt= 0.05 hrs
Type III 24-hr 10-yr Rainfall=4.68"

Area (sf)	CN	Description
1,071	98	Paved parking, HSG D
46,678	80	>75% Grass cover, Good, HSG D
2,307	73	Brush, Good, HSG D
63,211	77	Woods, Good, HSG D
113,267	78	Weighted Average
112,196		99.05% Pervious Area
1,071		0.95% Impervious Area

Tc (min)	Length (feet)	Slope (ft/ft)	Velocity (ft/sec)	Capacity (cfs)	Description
16.4	100	0.0400	0.10		Sheet Flow, Woods: Light underbrush n= 0.400 P2= 3.17"

Subcatchment PW1A: LOD

Hydrograph

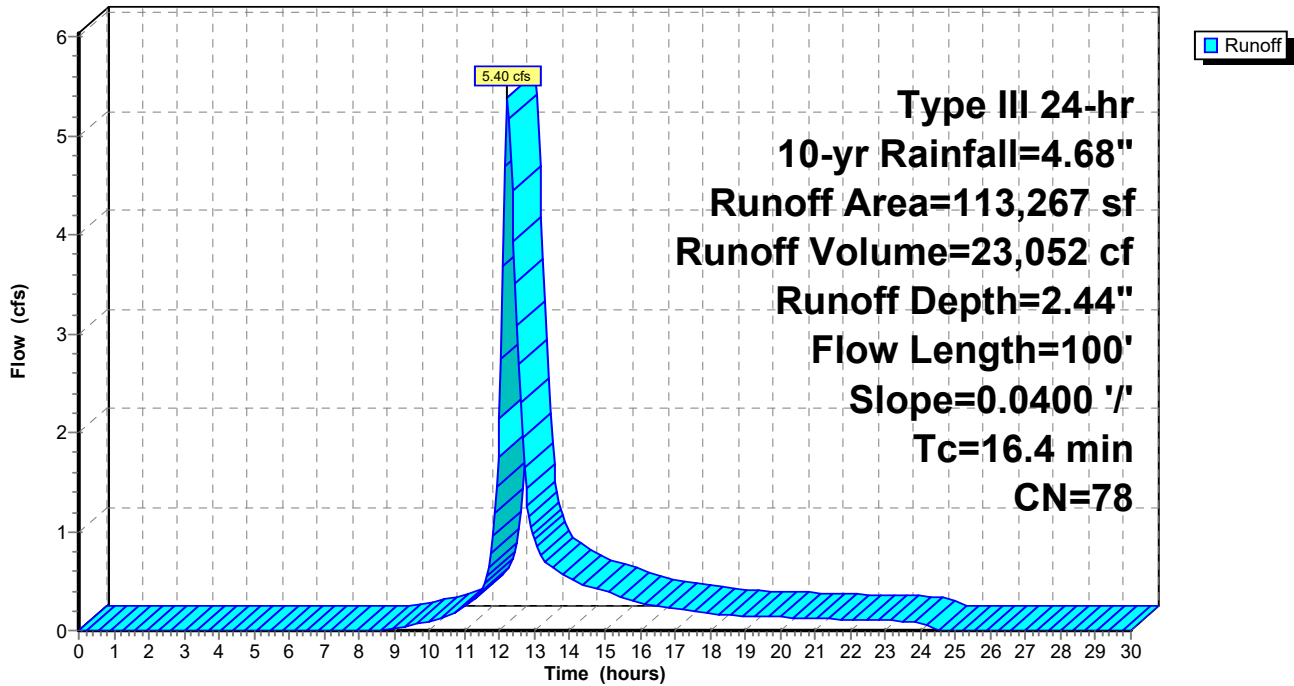

250109 Dewpoint North R3

Prepared by Colliers Engineering & Design

HydroCAD® 10.20-5c s/n 04431 © 2023 HydroCAD Software Solutions LLC

Type III 24-hr 10-yr Rainfall=4.68"

Printed 1/23/2025

Page 29

Summary for Subcatchment PW1B1: DRIVEWAY

Runoff = 2.43 cfs @ 12.09 hrs, Volume= 8,072 cf, Depth= 3.78"
 Routed to Pond 1B : BIO-1B

Runoff by SCS TR-20 method, UH=SCS, Weighted-CN, Time Span= 0.00-30.00 hrs, dt= 0.05 hrs
 Type III 24-hr 10-yr Rainfall=4.68"

Area (sf)	CN	Description
17,549	98	Paved parking, HSG D
8,097	80	>75% Grass cover, Good, HSG D
25,646	92	Weighted Average
8,097		31.57% Pervious Area
17,549		68.43% Impervious Area

Tc (min)	Length (feet)	Slope (ft/ft)	Velocity (ft/sec)	Capacity (cfs)	Description
6.0					Direct Entry,

Subcatchment PW1B1: DRIVEWAY

Hydrograph

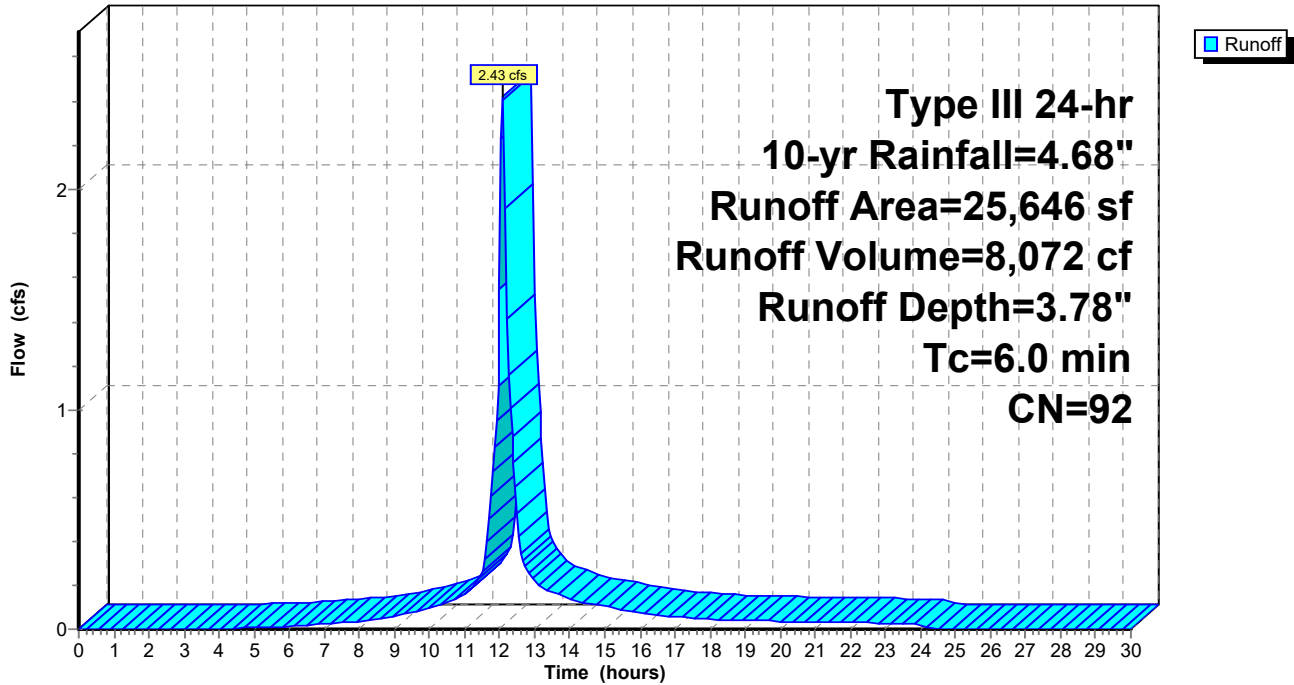

250109 Dewpoint North R3

Prepared by Colliers Engineering & Design

HydroCAD® 10.20-5c s/n 04431 © 2023 HydroCAD Software Solutions LLC

Type III 24-hr 10-yr Rainfall=4.68"

Printed 1/23/2025

Page 30

Summary for Subcatchment PW1B2: 1/2 ROOF

Runoff = 1.64 cfs @ 12.09 hrs, Volume= 5,925 cf, Depth= 4.44"

Routed to Pond 2P : DIVERSION

Runoff by SCS TR-20 method, UH=SCS, Weighted-CN, Time Span= 0.00-30.00 hrs, dt= 0.05 hrs
Type III 24-hr 10-yr Rainfall=4.68"

Area (sf)	CN	Description
* 16,000	98	
16,000		100.00% Impervious Area

Tc (min)	Length (feet)	Slope (ft/ft)	Velocity (ft/sec)	Capacity (cfs)	Description
6.0					Direct Entry,

Subcatchment PW1B2: 1/2 ROOF

Hydrograph

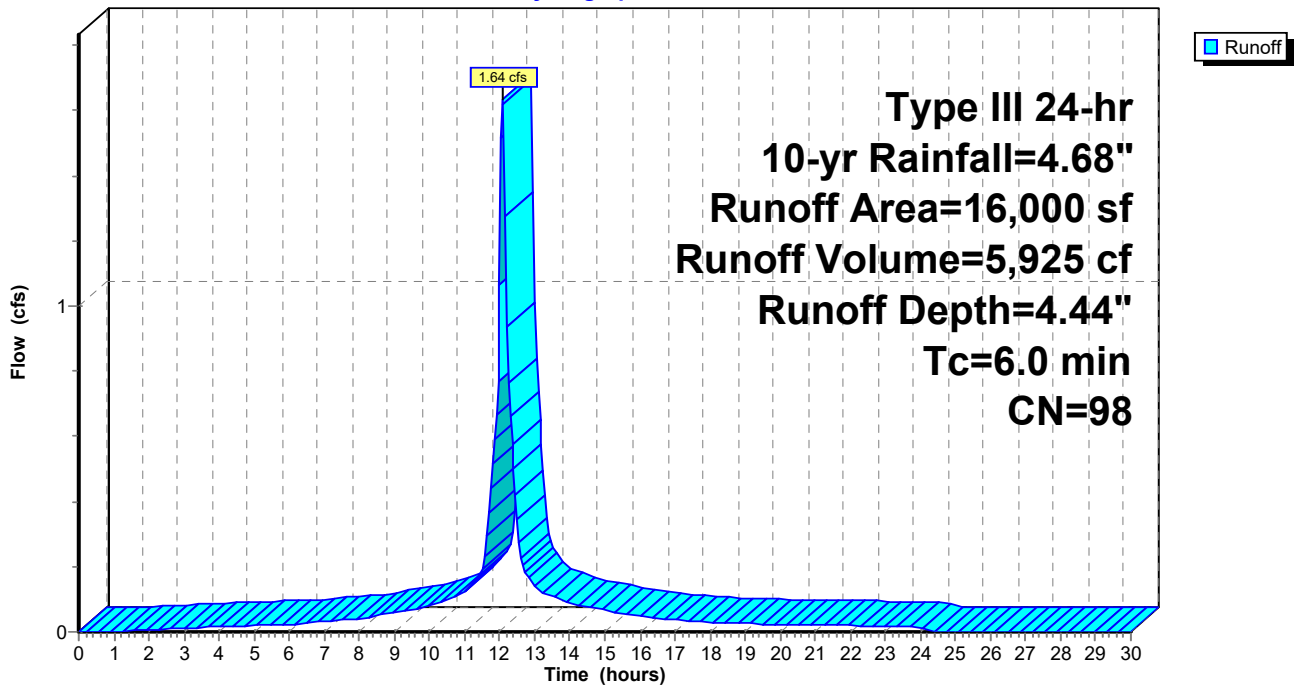

250109 Dewpoint North R3

Prepared by Colliers Engineering & Design

HydroCAD® 10.20-5c s/n 04431 © 2023 HydroCAD Software Solutions LLC

Type III 24-hr 10-yr Rainfall=4.68"

Printed 1/23/2025

Page 31

Summary for Subcatchment PW1C: PW1C

Runoff = 1.39 cfs @ 12.09 hrs, Volume= 4,536 cf, Depth= 3.57"
 Routed to Pond 1C : BIO-1C

Runoff by SCS TR-20 method, UH=SCS, Weighted-CN, Time Span= 0.00-30.00 hrs, dt= 0.05 hrs
 Type III 24-hr 10-yr Rainfall=4.68"

Area (sf)	CN	Description
8,081	98	Paved parking, HSG D
7,173	80	>75% Grass cover, Good, HSG D
15,254	90	Weighted Average
7,173		47.02% Pervious Area
8,081		52.98% Impervious Area

Tc (min)	Length (feet)	Slope (ft/ft)	Velocity (ft/sec)	Capacity (cfs)	Description
6.0					Direct Entry,

Subcatchment PW1C: PW1C

Hydrograph

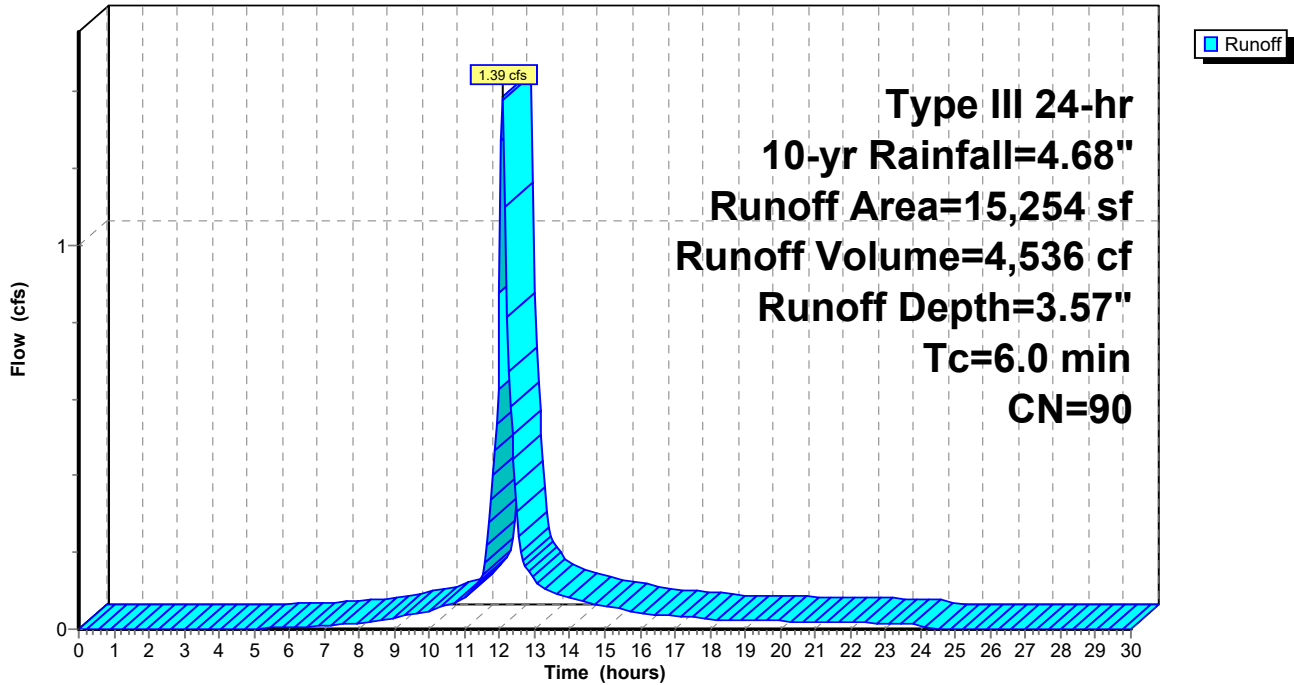

250109 Dewpoint North R3

Prepared by Colliers Engineering & Design

HydroCAD® 10.20-5c s/n 04431 © 2023 HydroCAD Software Solutions LLC

Type III 24-hr 10-yr Rainfall=4.68"

Printed 1/23/2025

Page 32

Summary for Subcatchment PW1D: PAVEMENT

Runoff = 3.96 cfs @ 12.09 hrs, Volume= 13,428 cf, Depth= 3.99"
 Routed to Pond 1D : BIO-1D

Runoff by SCS TR-20 method, UH=SCS, Weighted-CN, Time Span= 0.00-30.00 hrs, dt= 0.05 hrs
 Type III 24-hr 10-yr Rainfall=4.68"

Area (sf)	CN	Description
30,875	98	Paved parking, HSG D
9,484	80	>75% Grass cover, Good, HSG D
40,359	94	Weighted Average
9,484		23.50% Pervious Area
30,875		76.50% Impervious Area

Tc (min)	Length (feet)	Slope (ft/ft)	Velocity (ft/sec)	Capacity (cfs)	Description
6.0					Direct Entry,

Subcatchment PW1D: PAVEMENT

Hydrograph

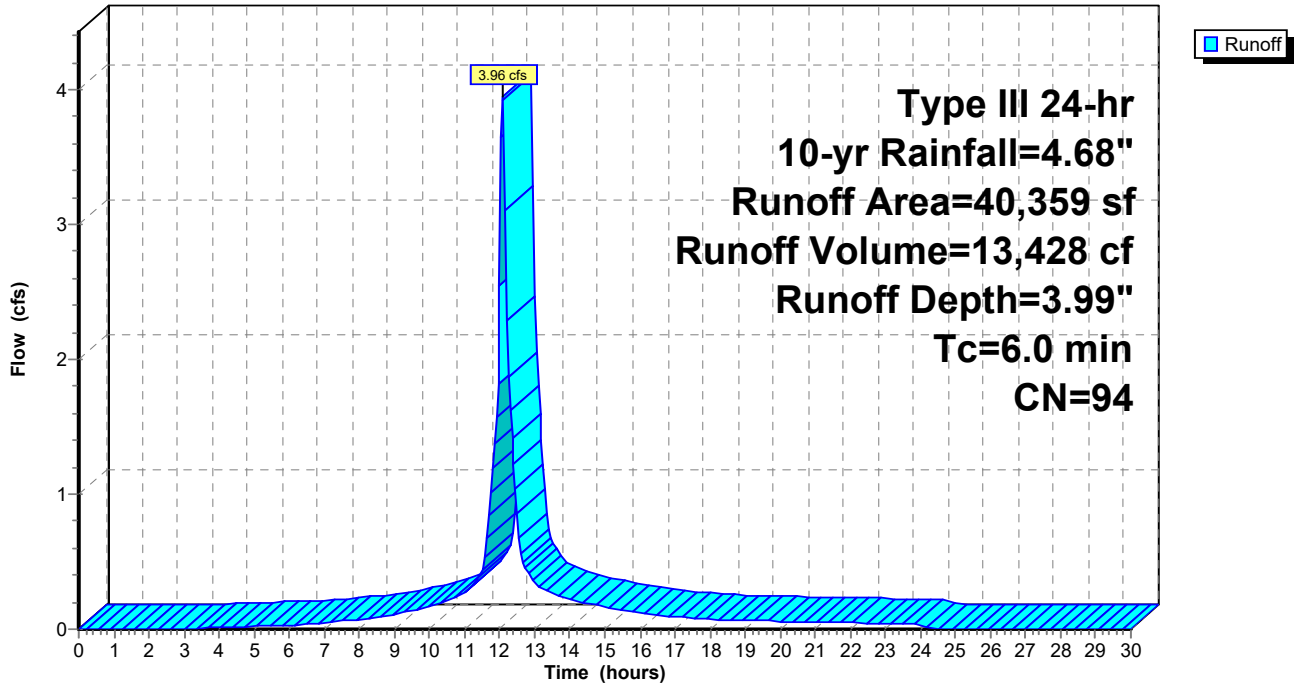

250109 Dewpoint North R3

Prepared by Colliers Engineering & Design

HydroCAD® 10.20-5c s/n 04431 © 2023 HydroCAD Software Solutions LLC

Type III 24-hr 10-yr Rainfall=4.68"

Printed 1/23/2025

Page 33

Summary for Subcatchment PW1E: LOADING

Runoff = 0.84 cfs @ 12.09 hrs, Volume= 2,746 cf, Depth= 3.57"
 Routed to Pond 1E : BIO-1E

Runoff by SCS TR-20 method, UH=SCS, Weighted-CN, Time Span= 0.00-30.00 hrs, dt= 0.05 hrs
 Type III 24-hr 10-yr Rainfall=4.68"

Area (sf)	CN	Description
5,385	98	Paved parking, HSG D
3,851	80	>75% Grass cover, Good, HSG D
9,236	90	Weighted Average
3,851		41.70% Pervious Area
5,385		58.30% Impervious Area

Tc (min)	Length (feet)	Slope (ft/ft)	Velocity (ft/sec)	Capacity (cfs)	Description
6.0					Direct Entry,

Subcatchment PW1E: LOADING

Hydrograph

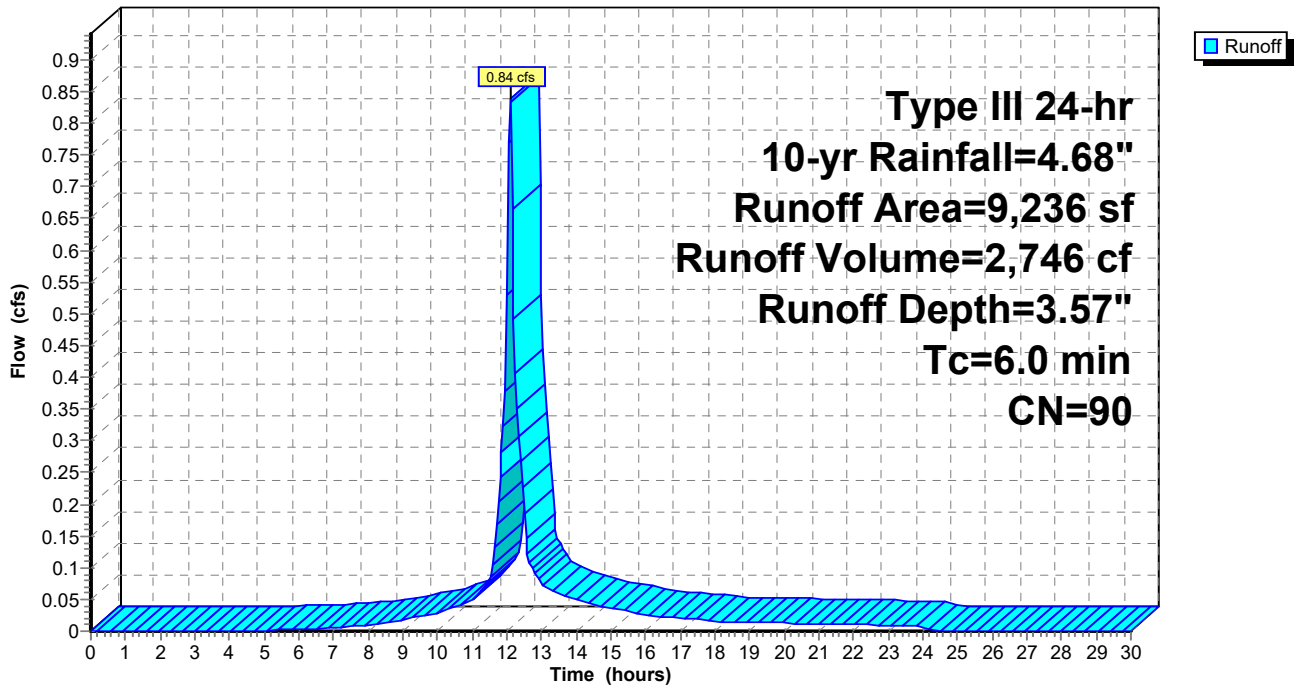

250109 Dewpoint North R3

Prepared by Colliers Engineering & Design

HydroCAD® 10.20-5c s/n 04431 © 2023 HydroCAD Software Solutions LLC

Type III 24-hr 10-yr Rainfall=4.68"

Printed 1/23/2025

Page 34

Summary for Subcatchment PW1F: FIRE LANE

Runoff = 0.44 cfs @ 12.09 hrs, Volume= 1,468 cf, Depth= 3.88"
 Routed to Pond 1F : BIO-1F

Runoff by SCS TR-20 method, UH=SCS, Weighted-CN, Time Span= 0.00-30.00 hrs, dt= 0.05 hrs
 Type III 24-hr 10-yr Rainfall=4.68"

Area (sf)	CN	Description
3,269	98	Paved parking, HSG D
1,268	80	>75% Grass cover, Good, HSG D
4,537	93	Weighted Average
1,268		27.95% Pervious Area
3,269		72.05% Impervious Area

Tc (min)	Length (feet)	Slope (ft/ft)	Velocity (ft/sec)	Capacity (cfs)	Description
6.0					Direct Entry,

Subcatchment PW1F: FIRE LANE

Hydrograph

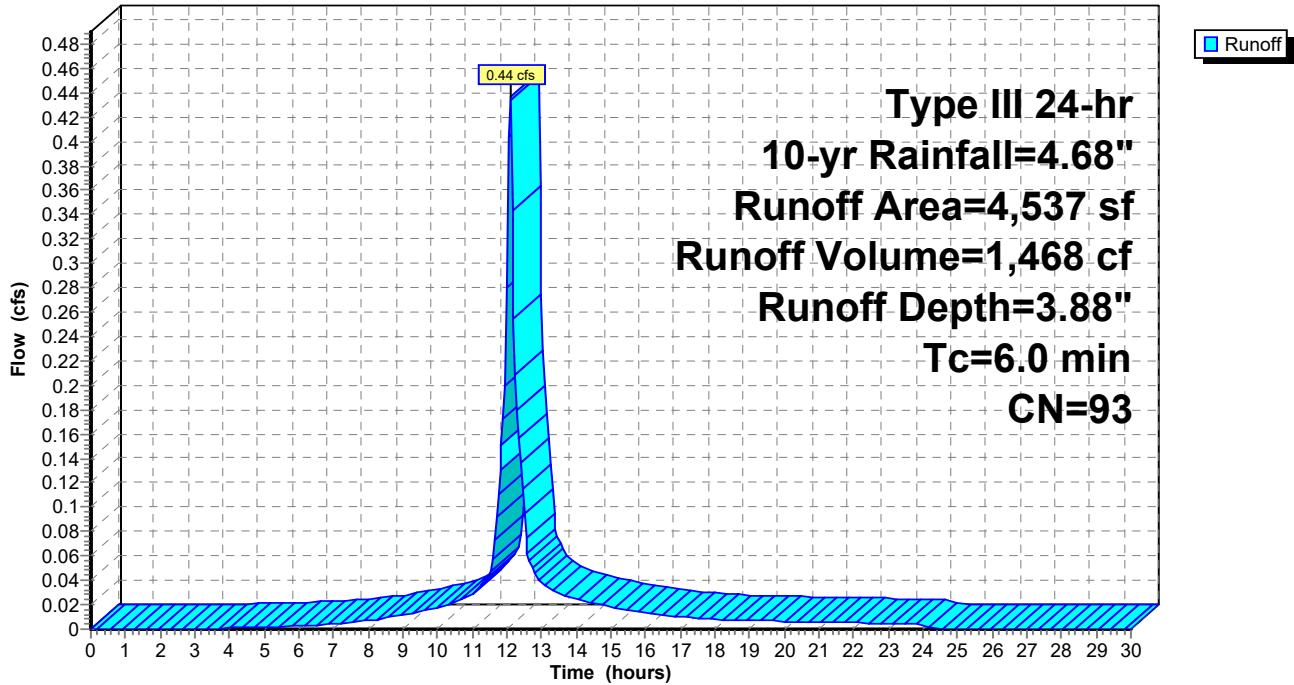

250109 Dewpoint North R3

Type III 24-hr 10-yr Rainfall=4.68"

Prepared by Colliers Engineering & Design

Printed 1/23/2025

HydroCAD® 10.20-5c s/n 04431 © 2023 HydroCAD Software Solutions LLC

Page 35

Summary for Pond 1B: BIO-1B

Inflow Area = 25,646 sf, 68.43% Impervious, Inflow Depth = 3.89" for 10-yr event
 Inflow = 2.99 cfs @ 12.09 hrs, Volume= 8,315 cf
 Outflow = 0.47 cfs @ 12.53 hrs, Volume= 8,033 cf, Atten= 84%, Lag= 26.5 min
 Primary = 0.47 cfs @ 12.53 hrs, Volume= 8,033 cf
 Routed to Link PR : DP1 (PROPOSED)

Routing by Dyn-Stor-Ind method, Time Span= 0.00-30.00 hrs, dt= 0.05 hrs
 Peak Elev= 475.51' @ 12.53 hrs Surf.Area= 2,891 sf Storage= 3,696 cf

Plug-Flow detention time= 136.7 min calculated for 8,033 cf (97% of inflow)
 Center-of-Mass det. time= 116.6 min (899.7 - 783.1)

Volume	Invert	Avail.Storage	Storage Description
#1	474.00'	12,985 cf	Custom Stage Data (Pyramidal) Listed below (Recalc)

Elevation (feet)	Surf.Area (sq-ft)	Inc.Store (cubic-feet)	Cum.Store (cubic-feet)	Wet.Area (sq-ft)
474.00	2,038	0	0	2,038
478.00	4,629	12,985	12,985	4,783

Device	Routing	Invert	Outlet Devices
#1	Device 4	477.60'	16.0' long x 0.5' breadth Broad-Crested Rectangular Weir Head (feet) 0.20 0.40 0.60 0.80 1.00 Coef. (English) 2.80 2.92 3.08 3.30 3.32
#2	Device 4	474.20'	4.0" Vert. Orifice/Grate C= 0.600 Limited to weir flow at low heads
#3	Device 4	474.00'	0.250 in/hr BIO MEDIA over Surface area
#4	Primary	470.50'	18.0" Round Culvert L= 17.8' CMP, square edge headwall, Ke= 0.500 Inlet / Outlet Invert= 470.50' / 470.14' S= 0.0202 '/' Cc= 0.900 n= 0.013 Corrugated PE, smooth interior, Flow Area= 1.77 sf

Primary OutFlow Max=0.47 cfs @ 12.53 hrs HW=475.51' TW=0.00' (Dynamic Tailwater)

- ↑ 4=Culvert (Passes 0.47 cfs of 17.55 cfs potential flow)
- ↑ 1=Broad-Crested Rectangular Weir (Controls 0.00 cfs)
- ↑ 2=Orifice/Grate (Orifice Controls 0.45 cfs @ 5.14 fps)
- ↑ 3=BIO MEDIA (Exfiltration Controls 0.02 cfs)

Pond 1B: BIO-1B

Hydrograph

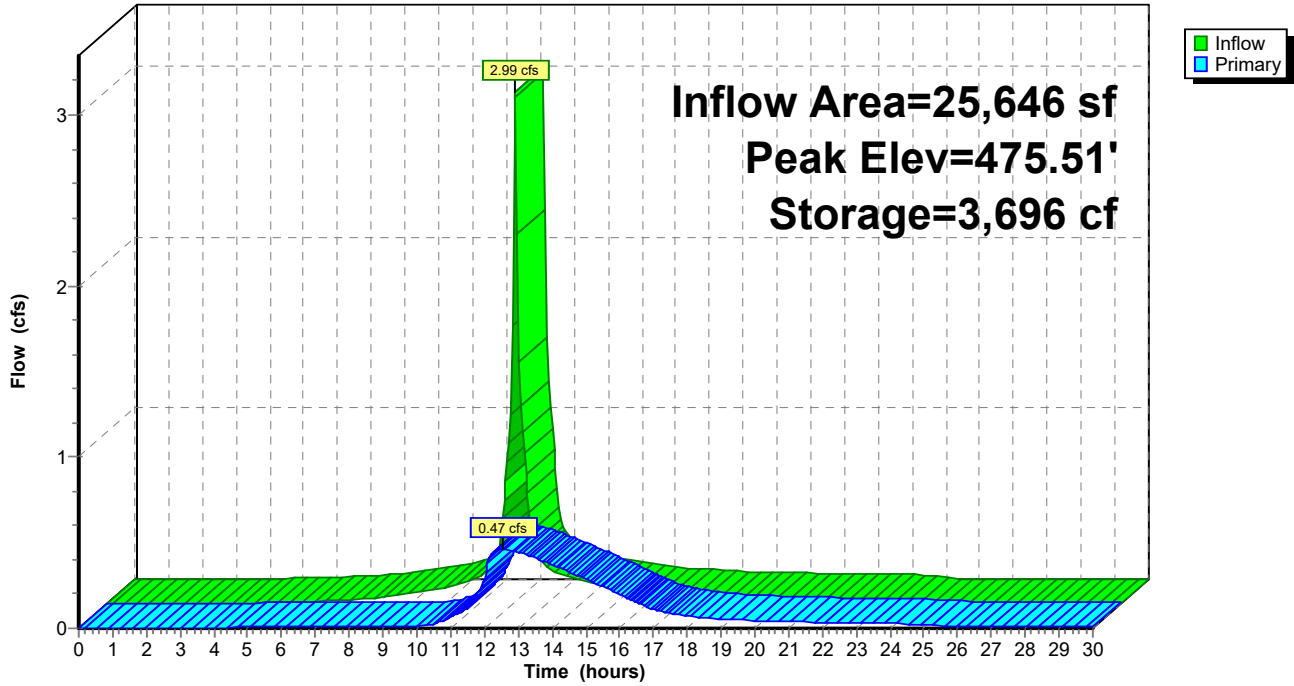

250109 Dewpoint North R3

Type III 24-hr 10-yr Rainfall=4.68"

Prepared by Colliers Engineering & Design

Printed 1/23/2025

HydroCAD® 10.20-5c s/n 04431 © 2023 HydroCAD Software Solutions LLC

Page 37

Stage-Area-Storage for Pond 1B: BIO-1B

Elevation (feet)	Surface (sq-ft)	Storage (cubic-feet)	Elevation (feet)	Surface (sq-ft)	Storage (cubic-feet)
474.00	2,038	0	476.60	3,603	7,237
474.05	2,064	103	476.65	3,637	7,418
474.10	2,090	206	476.70	3,672	7,601
474.15	2,116	312	476.75	3,707	7,785
474.20	2,143	418	476.80	3,742	7,972
474.25	2,169	526	476.85	3,777	8,160
474.30	2,196	635	476.90	3,812	8,349
474.35	2,223	745	476.95	3,847	8,541
474.40	2,250	857	477.00	3,883	8,734
474.45	2,277	970	477.05	3,919	8,929
474.50	2,305	1,085	477.10	3,955	9,126
474.55	2,332	1,201	477.15	3,991	9,325
474.60	2,360	1,318	477.20	4,027	9,525
474.65	2,388	1,437	477.25	4,063	9,727
474.70	2,416	1,557	477.30	4,100	9,931
474.75	2,444	1,678	477.35	4,137	10,137
474.80	2,472	1,801	477.40	4,174	10,345
474.85	2,501	1,926	477.45	4,211	10,555
474.90	2,530	2,051	477.50	4,248	10,766
474.95	2,558	2,179	477.55	4,285	10,979
475.00	2,587	2,307	477.60	4,323	11,195
475.05	2,617	2,437	477.65	4,360	11,412
475.10	2,646	2,569	477.70	4,398	11,631
475.15	2,676	2,702	477.75	4,436	11,852
475.20	2,705	2,837	477.80	4,475	12,074
475.25	2,735	2,973	477.85	4,513	12,299
475.30	2,765	3,110	477.90	4,551	12,526
475.35	2,795	3,249	477.95	4,590	12,754
475.40	2,826	3,390	478.00	4,629	12,985
475.45	2,856	3,532			
475.50	2,887	3,675			
475.55	2,918	3,820			
475.60	2,949	3,967			
475.65	2,980	4,115			
475.70	3,011	4,265			
475.75	3,043	4,416			
475.80	3,074	4,569			
475.85	3,106	4,724			
475.90	3,138	4,880			
475.95	3,170	5,037			
476.00	3,202	5,197			
476.05	3,235	5,358			
476.10	3,268	5,520			
476.15	3,300	5,685			
476.20	3,333	5,850			
476.25	3,366	6,018			
476.30	3,400	6,187			
476.35	3,433	6,358			
476.40	3,467	6,530			
476.45	3,501	6,705			
476.50	3,535	6,880			
476.55	3,569	7,058			

250109 Dewpoint North R3

Type III 24-hr 10-yr Rainfall=4.68"

Prepared by Colliers Engineering & Design

Printed 1/23/2025

HydroCAD® 10.20-5c s/n 04431 © 2023 HydroCAD Software Solutions LLC

Page 38

Summary for Pond 1C: BIO-1C

Inflow Area = 15,254 sf, 52.98% Impervious, Inflow Depth = 3.57" for 10-yr event
 Inflow = 1.39 cfs @ 12.09 hrs, Volume= 4,536 cf
 Outflow = 1.35 cfs @ 12.11 hrs, Volume= 4,283 cf, Atten= 3%, Lag= 1.3 min
 Primary = 1.35 cfs @ 12.11 hrs, Volume= 4,283 cf
 Routed to Pond 1D : BIO-1D

Routing by Dyn-Stor-Ind method, Time Span= 0.00-30.00 hrs, dt= 0.05 hrs
 Peak Elev= 495.40' @ 12.11 hrs Surf.Area= 1,556 sf Storage= 581 cf

Plug-Flow detention time= 88.2 min calculated for 4,283 cf (94% of inflow)
 Center-of-Mass det. time= 57.4 min (850.4 - 793.0)

Volume	Invert	Avail.Storage	Storage Description		
#1	495.00'	2,593 cf	Custom Stage Data (Pyramidal) listed below (Recalc)		
Elevation (feet)	Surf.Area (sq-ft)	Inc.Store (cubic-feet)	Cum.Store (cubic-feet)	Wet.Area (sq-ft)	
495.00	1,379	0	0	1,379	
496.50	2,104	2,593	2,593	2,146	

Device	Routing	Invert	Outlet Devices					
#1	Device 3	495.30'	16.0' long x 0.5' breadth Broad-Crested Rectangular Weir					
			Head (feet) 0.20 0.40 0.60 0.80 1.00					
			Coef. (English) 2.80 2.92 3.08 3.30 3.32					
#2	Device 3	495.00'	0.250 in/hr BIO MEDIA over Surface area					
#3	Primary	491.50'	18.0" Round Culvert L= 82.0' Ke= 0.500					
			Inlet / Outlet Invert= 491.50' / 479.00' S= 0.1524 '/' Cc= 0.900					
			n= 0.013 Corrugated PE, smooth interior, Flow Area= 1.77 sf					

Primary OutFlow Max=1.32 cfs @ 12.11 hrs HW=495.39' TW=480.20' (Dynamic Tailwater)
 3=Culvert (Passes 1.32 cfs of 15.09 cfs potential flow)
 1=Broad-Crested Rectangular Weir (Weir Controls 1.31 cfs @ 0.86 fps)
 2=BIO MEDIA (Exfiltration Controls 0.01 cfs)

Pond 1C: BIO-1C

Hydrograph

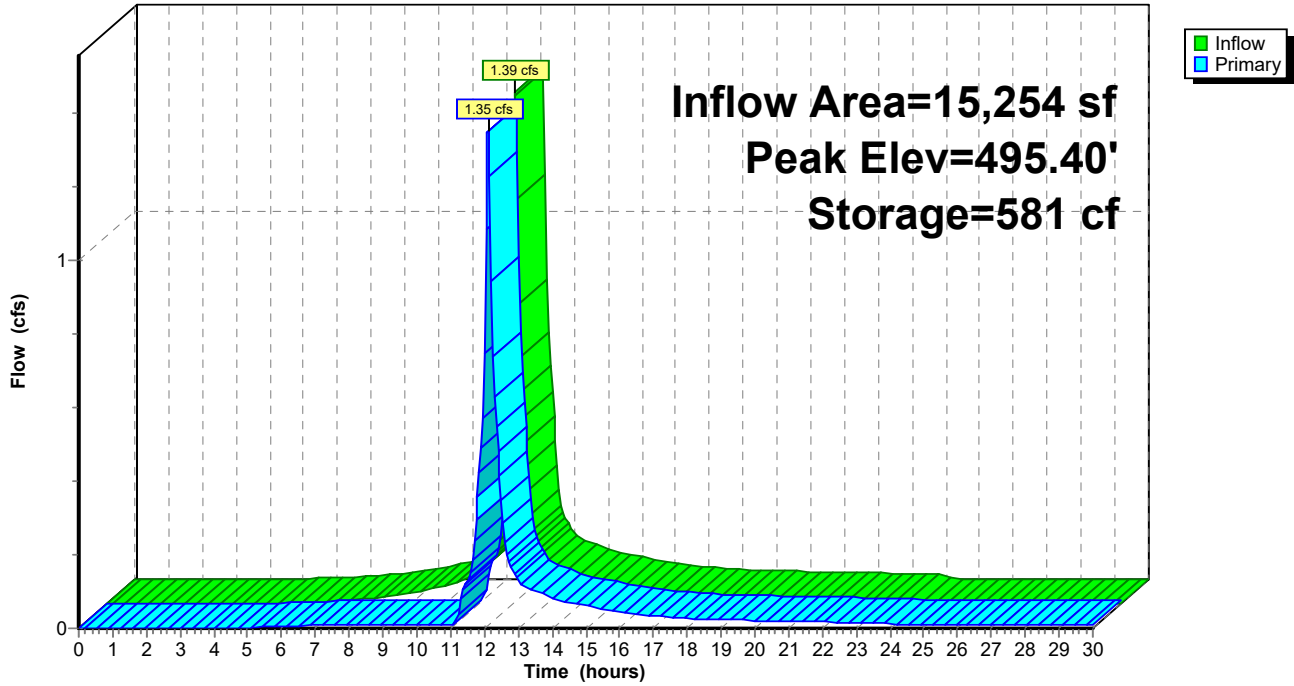

250109 Dewpoint North R3

Type III 24-hr 10-yr Rainfall=4.68"

Prepared by Colliers Engineering & Design

Printed 1/23/2025

HydroCAD® 10.20-5c s/n 04431 © 2023 HydroCAD Software Solutions LLC

Page 40

Stage-Area-Storage for Pond 1C: BIO-1C

Elevation (feet)	Surface (sq-ft)	Storage (cubic-feet)	Elevation (feet)	Surface (sq-ft)	Storage (cubic-feet)
495.00	1,379	0	496.04	1,865	1,681
495.02	1,388	28	496.06	1,876	1,718
495.04	1,396	56	496.08	1,886	1,756
495.06	1,405	84	496.10	1,896	1,794
495.08	1,414	112	496.12	1,906	1,832
495.10	1,423	140	496.14	1,916	1,870
495.12	1,431	169	496.16	1,926	1,908
495.14	1,440	197	496.18	1,937	1,947
495.16	1,449	226	496.20	1,947	1,986
495.18	1,458	255	496.22	1,957	2,025
495.20	1,467	285	496.24	1,967	2,064
495.22	1,476	314	496.26	1,978	2,103
495.24	1,485	344	496.28	1,988	2,143
495.26	1,494	373	496.30	1,999	2,183
495.28	1,503	403	496.32	2,009	2,223
495.30	1,512	433	496.34	2,019	2,263
495.32	1,521	464	496.36	2,030	2,304
495.34	1,530	494	496.38	2,040	2,345
495.36	1,539	525	496.40	2,051	2,385
495.38	1,548	556	496.42	2,061	2,427
495.40	1,557	587	496.44	2,072	2,468
495.42	1,567	618	496.46	2,083	2,509
495.44	1,576	650	496.48	2,093	2,551
495.46	1,585	681	496.50	2,104	2,593
495.48	1,594	713			
495.50	1,604	745			
495.52	1,613	777			
495.54	1,622	809			
495.56	1,632	842			
495.58	1,641	875			
495.60	1,651	908			
495.62	1,660	941			
495.64	1,670	974			
495.66	1,679	1,008			
495.68	1,689	1,041			
495.70	1,698	1,075			
495.72	1,708	1,109			
495.74	1,718	1,143			
495.76	1,727	1,178			
495.78	1,737	1,213			
495.80	1,747	1,247			
495.82	1,756	1,282			
495.84	1,766	1,318			
495.86	1,776	1,353			
495.88	1,786	1,389			
495.90	1,796	1,424			
495.92	1,806	1,461			
495.94	1,815	1,497			
495.96	1,825	1,533			
495.98	1,835	1,570			
496.00	1,845	1,607			
496.02	1,855	1,644			

250109 Dewpoint North R3

Type III 24-hr 10-yr Rainfall=4.68"

Prepared by Colliers Engineering & Design

Printed 1/23/2025

HydroCAD® 10.20-5c s/n 04431 © 2023 HydroCAD Software Solutions LLC

Page 41

Summary for Pond 1D: BIO-1D

Inflow Area = 71,613 sf, 76.74% Impervious, Inflow Depth > 3.92" for 10-yr event
 Inflow = 6.36 cfs @ 12.09 hrs, Volume= 23,393 cf
 Outflow = 2.43 cfs @ 12.37 hrs, Volume= 16,837 cf, Atten= 62%, Lag= 16.5 min
 Primary = 2.43 cfs @ 12.37 hrs, Volume= 16,837 cf
 Routed to Link PR : DP1 (PROPOSED)

Routing by Dyn-Stor-Ind method, Time Span= 0.00-30.00 hrs, dt= 0.05 hrs
 Peak Elev= 480.42' @ 12.37 hrs Surf.Area= 7,702 sf Storage= 10,372 cf

Plug-Flow detention time= (not calculated: outflow precedes inflow)
 Center-of-Mass det. time= 111.5 min (894.5 - 783.0)

Volume	Invert	Avail.Storage	Storage Description		
#1	479.00'	23,267 cf	Custom Stage Data (Pyramidal) Listed below (Recalc)		
Elevation (feet)	Surf.Area (sq-ft)	Inc.Store (cubic-feet)	Cum.Store (cubic-feet)	Wet.Area (sq-ft)	
479.00	6,887	0	0	6,887	
482.00	8,658	23,267	23,267	8,949	

Device	Routing	Invert	Outlet Devices
#1	Device 3	480.75'	16.0' long x 0.5' breadth Broad-Crested Rectangular Weir Head (feet) 0.20 0.40 0.60 0.80 1.00 Coef. (English) 2.80 2.92 3.08 3.30 3.32
#2	Device 3	479.00'	0.250 in/hr BIO MEDIA over Surface area
#3	Primary	475.50'	18.0" Round Culvert L= 22.6' CMP, square edge headwall, Ke= 0.500 Inlet / Outlet Invert= 475.50' / 474.80' S= 0.0310 '/' Cc= 0.900 n= 0.013 Corrugated PE, smooth interior, Flow Area= 1.77 sf
#4	Primary	480.00'	36.0" W x 4.0" H Vert. Orifice/Grate C= 0.600 Limited to weir flow at low heads

Primary OutFlow Max=2.43 cfs @ 12.37 hrs HW=480.42' TW=0.00' (Dynamic Tailwater)

- 3=Culvert (Passes 0.04 cfs of 17.38 cfs potential flow)
- 1=Broad-Crested Rectangular Weir (Controls 0.00 cfs)
- 2=BIO MEDIA (Exfiltration Controls 0.04 cfs)
- 4=Orifice/Grate (Orifice Controls 2.38 cfs @ 2.38 fps)

Pond 1D: BIO-1D

Hydrograph

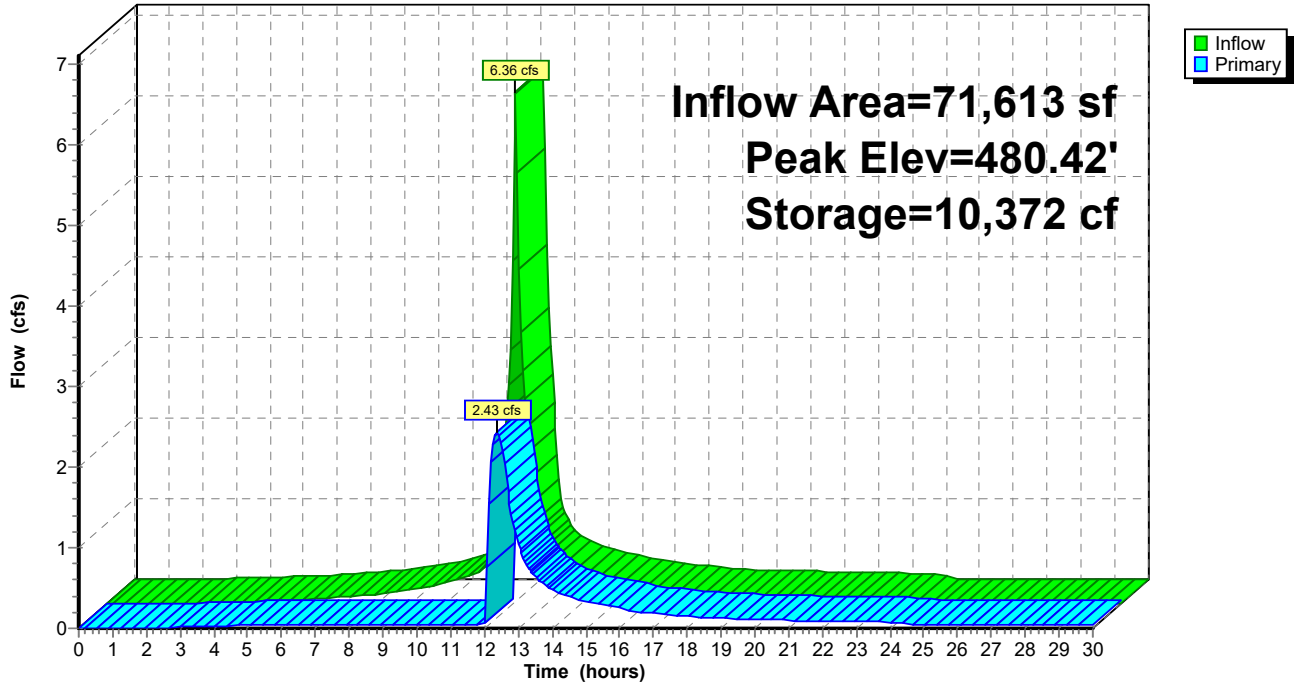

250109 Dewpoint North R3

Type III 24-hr 10-yr Rainfall=4.68"

Prepared by Colliers Engineering & Design

Printed 1/23/2025

HydroCAD® 10.20-5c s/n 04431 © 2023 HydroCAD Software Solutions LLC

Page 43

Stage-Area-Storage for Pond 1D: BIO-1D

Elevation (feet)	Surface (sq-ft)	Storage (cubic-feet)	Elevation (feet)	Surface (sq-ft)	Storage (cubic-feet)
479.00	6,887	0	481.60	8,410	19,853
479.05	6,915	345	481.65	8,441	20,275
479.10	6,943	691	481.70	8,472	20,697
479.15	6,971	1,039	481.75	8,503	21,122
479.20	6,999	1,389	481.80	8,534	21,548
479.25	7,027	1,739	481.85	8,565	21,975
479.30	7,055	2,091	481.90	8,596	22,404
479.35	7,083	2,445	481.95	8,627	22,835
479.40	7,111	2,800	482.00	8,658	23,267
479.45	7,140	3,156			
479.50	7,168	3,514			
479.55	7,197	3,873			
479.60	7,225	4,233			
479.65	7,254	4,595			
479.70	7,282	4,959			
479.75	7,311	5,323			
479.80	7,339	5,690			
479.85	7,368	6,057			
479.90	7,397	6,426			
479.95	7,426	6,797			
480.00	7,455	7,169			
480.05	7,484	7,543			
480.10	7,513	7,917			
480.15	7,542	8,294			
480.20	7,571	8,672			
480.25	7,600	9,051			
480.30	7,630	9,432			
480.35	7,659	9,814			
480.40	7,688	10,198			
480.45	7,718	10,583			
480.50	7,747	10,969			
480.55	7,777	11,357			
480.60	7,806	11,747			
480.65	7,836	12,138			
480.70	7,866	12,531			
480.75	7,895	12,925			
480.80	7,925	13,320			
480.85	7,955	13,717			
480.90	7,985	14,116			
480.95	8,015	14,516			
481.00	8,045	14,917			
481.05	8,075	15,320			
481.10	8,105	15,725			
481.15	8,136	16,131			
481.20	8,166	16,538			
481.25	8,196	16,947			
481.30	8,227	17,358			
481.35	8,257	17,770			
481.40	8,288	18,184			
481.45	8,318	18,599			
481.50	8,349	19,015			
481.55	8,379	19,434			

250109 Dewpoint North R3

Type III 24-hr 10-yr Rainfall=4.68"

Prepared by Colliers Engineering & Design

Printed 1/23/2025

HydroCAD® 10.20-5c s/n 04431 © 2023 HydroCAD Software Solutions LLC

Page 44

Summary for Pond 1E: BIO-1E

Inflow Area = 9,236 sf, 58.30% Impervious, Inflow Depth = 3.57" for 10-yr event
 Inflow = 0.84 cfs @ 12.09 hrs, Volume= 2,746 cf
 Outflow = 0.26 cfs @ 12.41 hrs, Volume= 1,964 cf, Atten= 69%, Lag= 19.3 min
 Primary = 0.26 cfs @ 12.41 hrs, Volume= 1,964 cf
 Routed to Link PR : DP1 (PROPOSED)

Routing by Dyn-Stor-Ind method, Time Span= 0.00-30.00 hrs, dt= 0.05 hrs
 Peak Elev= 490.36' @ 12.41 hrs Surf.Area= 1,193 sf Storage= 1,280 cf

Plug-Flow detention time= 224.8 min calculated for 1,964 cf (72% of inflow)
 Center-of-Mass det. time= 134.6 min (927.6 - 793.0)

Volume	Invert	Avail.Storage	Storage Description		
#1	489.00'	3,828 cf	Custom Stage Data (Pyramidal) Listed below (Recalc)		
Elevation (feet)	Surf.Area (sq-ft)	Inc.Store (cubic-feet)	Cum.Store (cubic-feet)	Wet.Area (sq-ft)	
489.00	715	0	0	715	
492.00	1,936	3,828	3,828	2,008	

Device	Routing	Invert	Outlet Devices
#1	Device 4	491.00'	16.0' long x 0.5' breadth Broad-Crested Rectangular Weir Head (feet) 0.20 0.40 0.60 0.80 1.00 Coef. (English) 2.80 2.92 3.08 3.30 3.32
#2	Device 4	490.00'	5.0" Vert. Orifice/Grate C= 0.600 Limited to weir flow at low heads
#3	Device 4	489.00'	0.250 in/hr BIO MEDIA over Surface area
#4	Primary	485.50'	12.0" Round Culvert L= 33.0' CMP, square edge headwall, Ke= 0.500 Inlet / Outlet Invert= 485.50' / 480.00' S= 0.1667 '/' Cc= 0.900 n= 0.013 Corrugated PE, smooth interior, Flow Area= 0.79 sf

Primary OutFlow Max=0.26 cfs @ 12.41 hrs HW=490.36' TW=0.00' (Dynamic Tailwater)

- ↑ **4=Culvert** (Passes 0.26 cfs of 7.89 cfs potential flow)
- ↑ **1=Broad-Crested Rectangular Weir** (Controls 0.00 cfs)
- ↑ **2=Orifice/Grate** (Orifice Controls 0.25 cfs @ 2.03 fps)
- ↑ **3=BIO MEDIA** (Exfiltration Controls 0.01 cfs)

Pond 1E: BIO-1E

Hydrograph

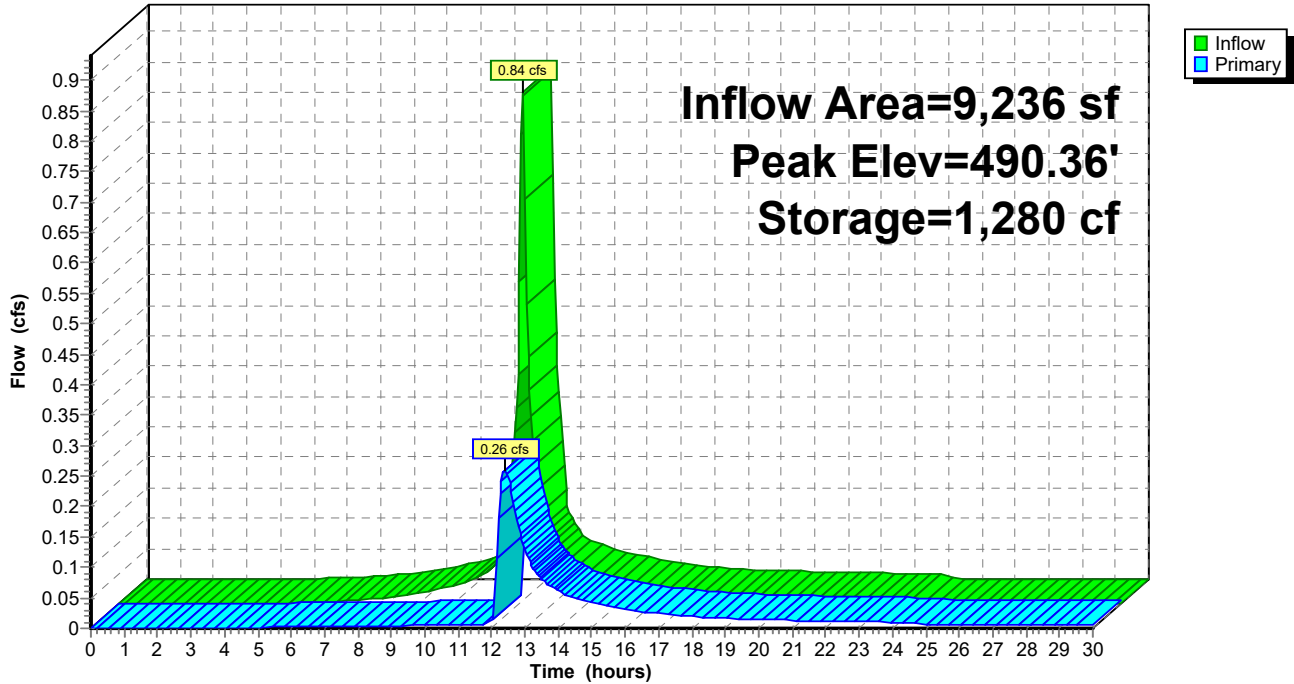

250109 Dewpoint North R3

Type III 24-hr 10-yr Rainfall=4.68"

Prepared by Colliers Engineering & Design

Printed 1/23/2025

HydroCAD® 10.20-5c s/n 04431 © 2023 HydroCAD Software Solutions LLC

Page 46

Stage-Area-Storage for Pond 1E: BIO-1E

Elevation (feet)	Surface (sq-ft)	Storage (cubic-feet)	Elevation (feet)	Surface (sq-ft)	Storage (cubic-feet)
489.00	715	0	491.60	1,739	3,093
489.05	730	36	491.65	1,763	3,180
489.10	746	73	491.70	1,787	3,269
489.15	762	111	491.75	1,811	3,359
489.20	778	149	491.80	1,836	3,450
489.25	794	189	491.85	1,861	3,543
489.30	810	229	491.90	1,886	3,636
489.35	827	270	491.95	1,911	3,731
489.40	843	311	492.00	1,936	3,828
489.45	860	354			
489.50	877	397			
489.55	894	442			
489.60	912	487			
489.65	929	533			
489.70	947	580			
489.75	964	627			
489.80	982	676			
489.85	1,000	726			
489.90	1,019	776			
489.95	1,037	828			
490.00	1,056	880			
490.05	1,075	933			
490.10	1,094	987			
490.15	1,113	1,042			
490.20	1,132	1,099			
490.25	1,151	1,156			
490.30	1,171	1,214			
490.35	1,191	1,273			
490.40	1,211	1,333			
490.45	1,231	1,394			
490.50	1,251	1,456			
490.55	1,271	1,519			
490.60	1,292	1,583			
490.65	1,313	1,648			
490.70	1,334	1,714			
490.75	1,355	1,782			
490.80	1,376	1,850			
490.85	1,398	1,919			
490.90	1,419	1,990			
490.95	1,441	2,061			
491.00	1,463	2,134			
491.05	1,485	2,207			
491.10	1,507	2,282			
491.15	1,530	2,358			
491.20	1,552	2,435			
491.25	1,575	2,513			
491.30	1,598	2,593			
491.35	1,621	2,673			
491.40	1,644	2,755			
491.45	1,668	2,837			
491.50	1,691	2,921			
491.55	1,715	3,007			

250109 Dewpoint North R3

Type III 24-hr 10-yr Rainfall=4.68"

Prepared by Colliers Engineering & Design

Printed 1/23/2025

HydroCAD® 10.20-5c s/n 04431 © 2023 HydroCAD Software Solutions LLC

Page 47

Summary for Pond 1F: BIO-1F

Inflow Area = 4,537 sf, 72.05% Impervious, Inflow Depth = 3.88" for 10-yr event
 Inflow = 0.44 cfs @ 12.09 hrs, Volume= 1,468 cf
 Outflow = 0.46 cfs @ 12.11 hrs, Volume= 1,083 cf, Atten= 0%, Lag= 1.6 min
 Primary = 0.46 cfs @ 12.11 hrs, Volume= 1,083 cf
 Routed to Link PR : DP1 (PROPOSED)

Routing by Dyn-Stor-Ind method, Time Span= 0.00-30.00 hrs, dt= 0.05 hrs
 Peak Elev= 482.07' @ 12.12 hrs Surf.Area= 601 sf Storage= 496 cf

Plug-Flow detention time= 193.4 min calculated for 1,081 cf (74% of inflow)
 Center-of-Mass det. time= 108.1 min (888.4 - 780.3)

Volume	Invert	Avail.Storage	Storage Description		
#1	481.00'	781 cf	Custom Stage Data (Pyramidal) Listed below (Recalc)		
Elevation (feet)	Surf.Area (sq-ft)	Inc.Store (cubic-feet)	Cum.Store (cubic-feet)	Wet.Area (sq-ft)	
481.00	339	0	0	339	
482.50	727	781	781	750	

Device	Routing	Invert	Outlet Devices									
#1	Primary	482.00'	10.0' long x 10.0' breadth Broad-Crested Rectangular Weir									
			Head (feet) 0.20 0.40 0.60 0.80 1.00 1.20 1.40 1.60									
			Coef. (English) 2.49 2.56 2.70 2.69 2.68 2.69 2.67 2.64									
#2	Primary	481.00'	0.250 in/hr BIO MEDIA over Surface area									

Primary OutFlow Max=0.43 cfs @ 12.11 hrs HW=482.07' TW=0.00' (Dynamic Tailwater)

- 1=Broad-Crested Rectangular Weir (Weir Controls 0.42 cfs @ 0.64 fps)
- 2=BIO MEDIA (Exfiltration Controls 0.00 cfs)

Pond 1F: BIO-1F

Hydrograph

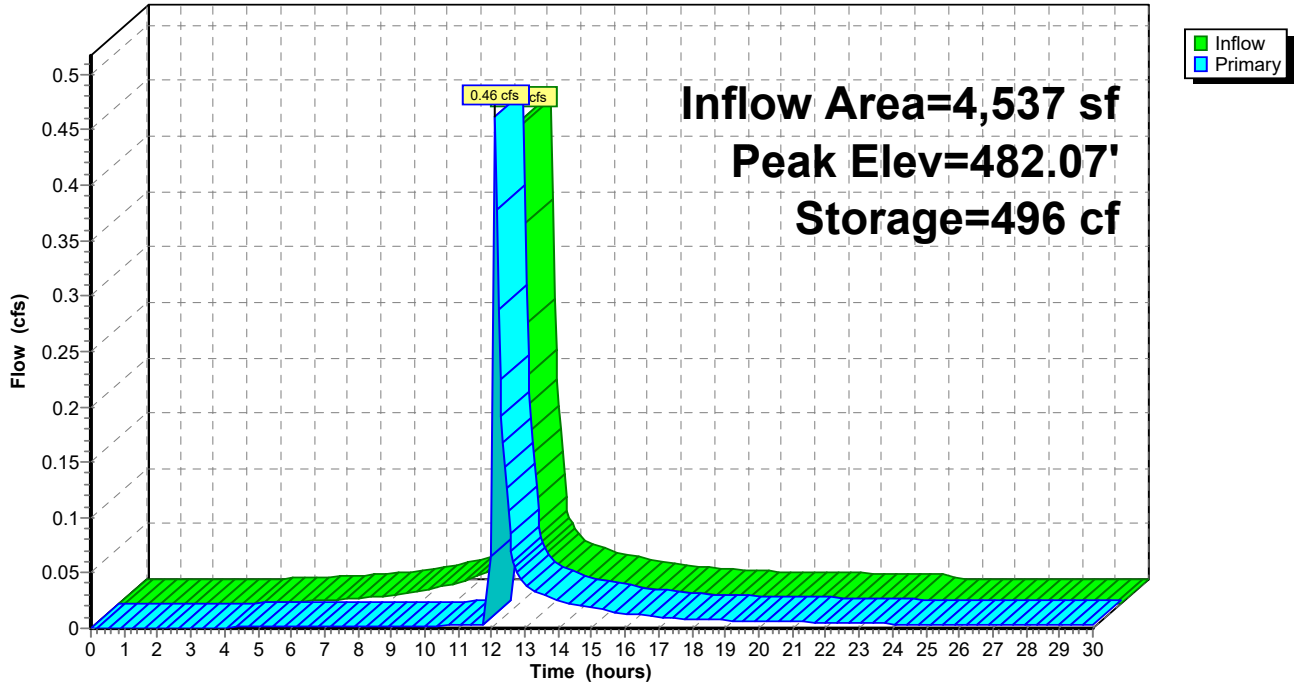

250109 Dewpoint North R3

Type III 24-hr 10-yr Rainfall=4.68"

Prepared by Colliers Engineering & Design

Printed 1/23/2025

HydroCAD® 10.20-5c s/n 04431 © 2023 HydroCAD Software Solutions LLC

Page 49

Stage-Area-Storage for Pond 1F: BIO-1F

Elevation (feet)	Surface (sq-ft)	Storage (cubic-feet)	Elevation (feet)	Surface (sq-ft)	Storage (cubic-feet)
481.00	339	0	482.04	592	478
481.02	343	7	482.06	598	490
481.04	347	14	482.08	604	502
481.06	352	21	482.10	609	514
481.08	356	28	482.12	615	527
481.10	360	35	482.14	621	539
481.12	365	42	482.16	626	551
481.14	369	50	482.18	632	564
481.16	373	57	482.20	638	577
481.18	378	64	482.22	643	589
481.20	382	72	482.24	649	602
481.22	387	80	482.26	655	615
481.24	391	88	482.28	661	629
481.26	396	95	482.30	667	642
481.28	400	103	482.32	673	655
481.30	405	111	482.34	679	669
481.32	410	120	482.36	685	682
481.34	414	128	482.38	691	696
481.36	419	136	482.40	697	710
481.38	423	145	482.42	703	724
481.40	428	153	482.44	709	738
481.42	433	162	482.46	715	752
481.44	438	170	482.48	721	767
481.46	442	179	482.50	727	781
481.48	447	188			
481.50	452	197			
481.52	457	206			
481.54	462	215			
481.56	467	225			
481.58	472	234			
481.60	477	244			
481.62	482	253			
481.64	487	263			
481.66	492	273			
481.68	497	282			
481.70	502	292			
481.72	507	303			
481.74	512	313			
481.76	517	323			
481.78	523	333			
481.80	528	344			
481.82	533	355			
481.84	538	365			
481.86	544	376			
481.88	549	387			
481.90	554	398			
481.92	560	409			
481.94	565	420			
481.96	570	432			
481.98	576	443			
482.00	581	455			
482.02	587	466			

250109 Dewpoint North R3

Prepared by Colliers Engineering & Design

HydroCAD® 10.20-5c s/n 04431 © 2023 HydroCAD Software Solutions LLC

Type III 24-hr 10-yr Rainfall=4.68"

Printed 1/23/2025

Page 50

Summary for Pond 2P: DIVERSION

Inflow Area = 16,000 sf, 100.00% Impervious, Inflow Depth = 4.44" for 10-yr event
 Inflow = 1.64 cfs @ 12.09 hrs, Volume= 5,925 cf
 Outflow = 1.64 cfs @ 12.09 hrs, Volume= 5,925 cf, Atten= 0%, Lag= 0.0 min
 Primary = 1.08 cfs @ 12.09 hrs, Volume= 5,682 cf
 Routed to Pond 1D : BIO-1D
 Secondary = 0.56 cfs @ 12.09 hrs, Volume= 243 cf
 Routed to Pond 1B : BIO-1B

Routing by Dyn-Stor-Ind method, Time Span= 0.00-30.00 hrs, dt= 0.05 hrs
 Peak Elev= 489.55' @ 12.09 hrs

Device	Routing	Invert	Outlet Devices
#1	Primary	488.00'	6.0" Round Culvert L= 12.0' CMP, square edge headwall, Ke= 0.500 Inlet / Outlet Invert= 488.00' / 486.00' S= 0.1667 '/' Cc= 0.900 n= 0.013 Corrugated PE, smooth interior, Flow Area= 0.20 sf
#2	Secondary	489.20'	15.0" Round Culvert L= 250.0' Ke= 0.500 Inlet / Outlet Invert= 489.20' / 470.00' S= 0.0768 '/' Cc= 0.900 n= 0.013 Corrugated PE, smooth interior, Flow Area= 1.23 sf

Primary OutFlow Max=1.07 cfs @ 12.09 hrs HW=489.54' TW=480.14' (Dynamic Tailwater)
 ↑1=Culvert (Inlet Controls 1.07 cfs @ 5.46 fps)

Secondary OutFlow Max=0.52 cfs @ 12.09 hrs HW=489.54' TW=475.05' (Dynamic Tailwater)
 ↑2=Culvert (Inlet Controls 0.52 cfs @ 1.97 fps)

Pond 2P: DIVERSION

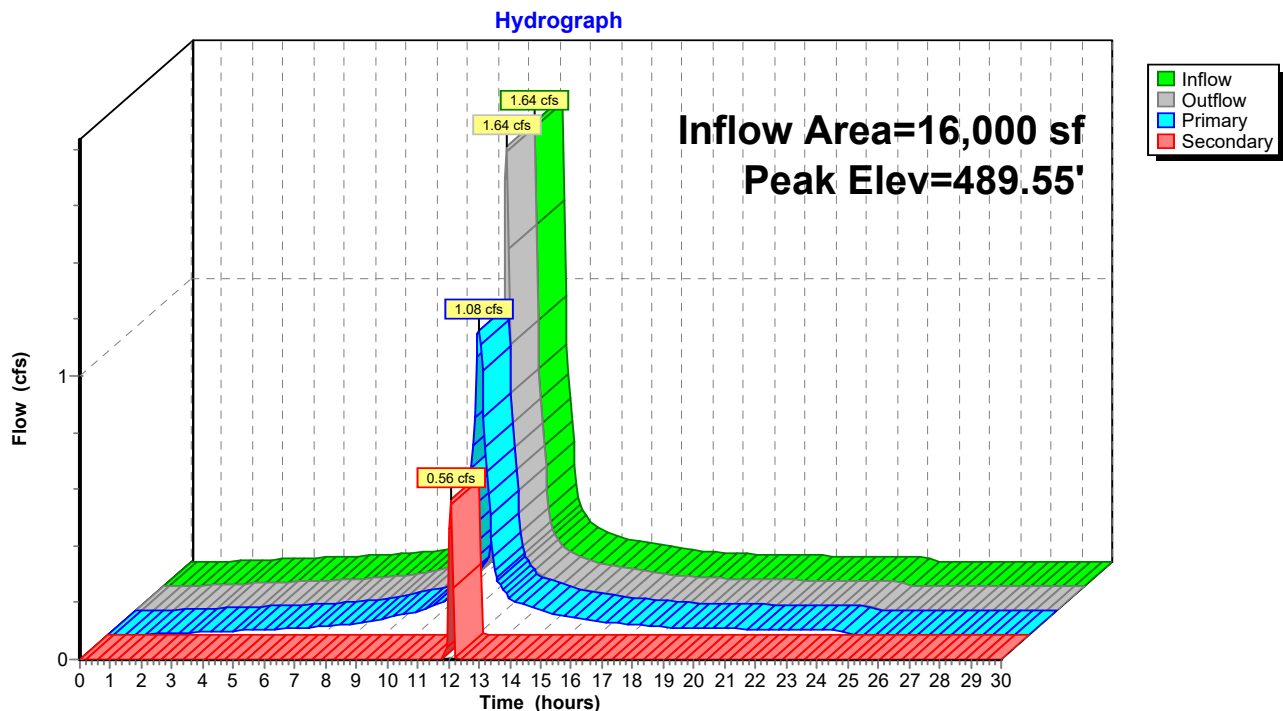

250109 Dewpoint North R3

Type III 24-hr 10-yr Rainfall=4.68"

Prepared by Colliers Engineering & Design

Printed 1/23/2025

HydroCAD® 10.20-5c s/n 04431 © 2023 HydroCAD Software Solutions LLC

Page 51

Stage-Area-Storage for Pond 2P: DIVERSION

Elevation (feet)	Storage (cubic-feet)	Elevation (feet)	Storage (cubic-feet)	Elevation (feet)	Storage (cubic-feet)
488.00	0	489.04	0	490.08	0
488.02	0	489.06	0	490.10	0
488.04	0	489.08	0	490.12	0
488.06	0	489.10	0	490.14	0
488.08	0	489.12	0	490.16	0
488.10	0	489.14	0	490.18	0
488.12	0	489.16	0	490.20	0
488.14	0	489.18	0	490.22	0
488.16	0	489.20	0	490.24	0
488.18	0	489.22	0	490.26	0
488.20	0	489.24	0	490.28	0
488.22	0	489.26	0	490.30	0
488.24	0	489.28	0	490.32	0
488.26	0	489.30	0	490.34	0
488.28	0	489.32	0	490.36	0
488.30	0	489.34	0	490.38	0
488.32	0	489.36	0	490.40	0
488.34	0	489.38	0	490.42	0
488.36	0	489.40	0	490.44	0
488.38	0	489.42	0		
488.40	0	489.44	0		
488.42	0	489.46	0		
488.44	0	489.48	0		
488.46	0	489.50	0		
488.48	0	489.52	0		
488.50	0	489.54	0		
488.52	0	489.56	0		
488.54	0	489.58	0		
488.56	0	489.60	0		
488.58	0	489.62	0		
488.60	0	489.64	0		
488.62	0	489.66	0		
488.64	0	489.68	0		
488.66	0	489.70	0		
488.68	0	489.72	0		
488.70	0	489.74	0		
488.72	0	489.76	0		
488.74	0	489.78	0		
488.76	0	489.80	0		
488.78	0	489.82	0		
488.80	0	489.84	0		
488.82	0	489.86	0		
488.84	0	489.88	0		
488.86	0	489.90	0		
488.88	0	489.92	0		
488.90	0	489.94	0		
488.92	0	489.96	0		
488.94	0	489.98	0		
488.96	0	490.00	0		
488.98	0	490.02	0		
489.00	0	490.04	0		
489.02	0	490.06	0		

250109 Dewpoint North R3

Prepared by Colliers Engineering & Design

HydroCAD® 10.20-5c s/n 04431 © 2023 HydroCAD Software Solutions LLC

Type III 24-hr 10-yr Rainfall=4.68"

Printed 1/23/2025

Page 52

Summary for Link PR: DP1 (PROPOSED)

Inflow Area = 224,299 sf, 36.66% Impervious, Inflow Depth > 2.73" for 10-yr event
Inflow = 8.54 cfs @ 12.25 hrs, Volume= 50,970 cf
Primary = 8.54 cfs @ 12.25 hrs, Volume= 50,970 cf, Atten= 0%, Lag= 0.0 min

Primary outflow = Inflow, Time Span= 0.00-30.00 hrs, dt= 0.05 hrs

Link PR: DP1 (PROPOSED)

Hydrograph

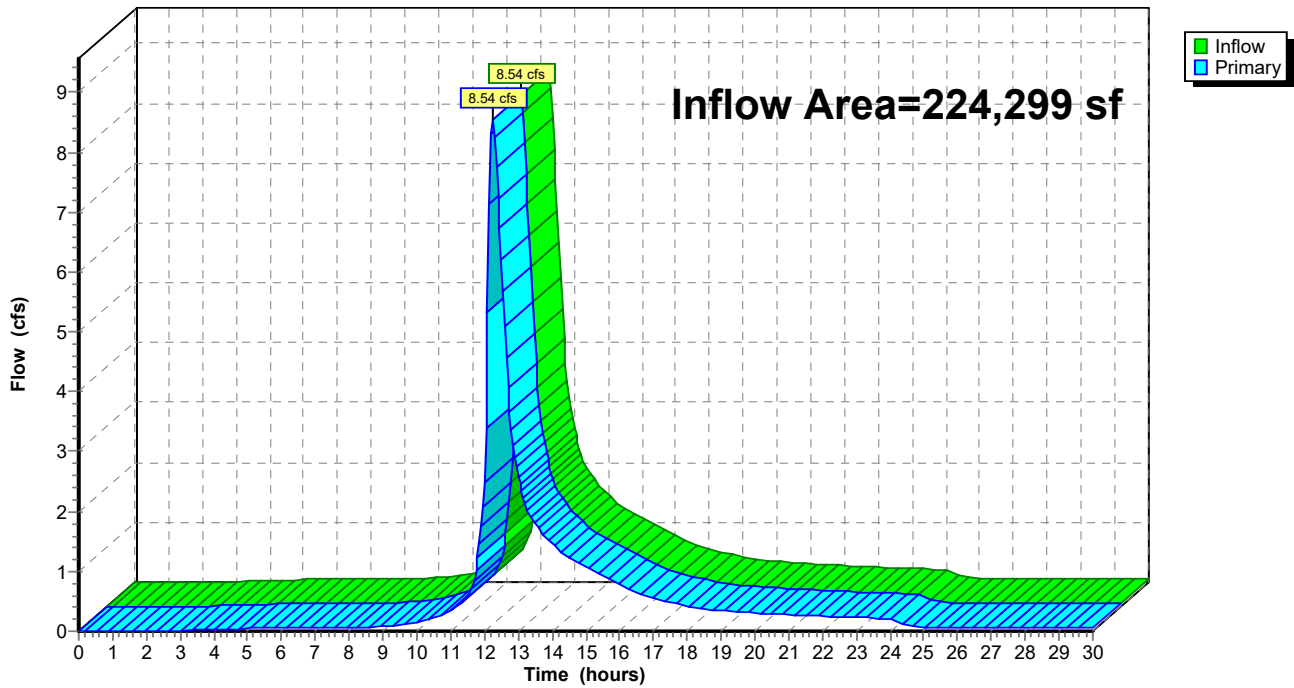

250109 Dewpoint North R3

Prepared by Colliers Engineering & Design

HydroCAD® 10.20-5c s/n 04431 © 2023 HydroCAD Software Solutions LLC

Type III 24-hr 100-yr Rainfall=8.22"

Printed 1/23/2025

Page 53

Summary for Subcatchment PW1A: LOD

Runoff = 12.32 cfs @ 12.22 hrs, Volume= 52,808 cf, Depth= 5.59"

Routed to Link PR : DP1 (PROPOSED)

Runoff by SCS TR-20 method, UH=SCS, Weighted-CN, Time Span= 0.00-30.00 hrs, dt= 0.05 hrs
Type III 24-hr 100-yr Rainfall=8.22"

Area (sf)	CN	Description
1,071	98	Paved parking, HSG D
46,678	80	>75% Grass cover, Good, HSG D
2,307	73	Brush, Good, HSG D
63,211	77	Woods, Good, HSG D
113,267	78	Weighted Average
112,196		99.05% Pervious Area
1,071		0.95% Impervious Area

Tc (min)	Length (feet)	Slope (ft/ft)	Velocity (ft/sec)	Capacity (cfs)	Description
16.4	100	0.0400	0.10		Sheet Flow, Woods: Light underbrush n= 0.400 P2= 3.17"

Subcatchment PW1A: LOD

Hydrograph

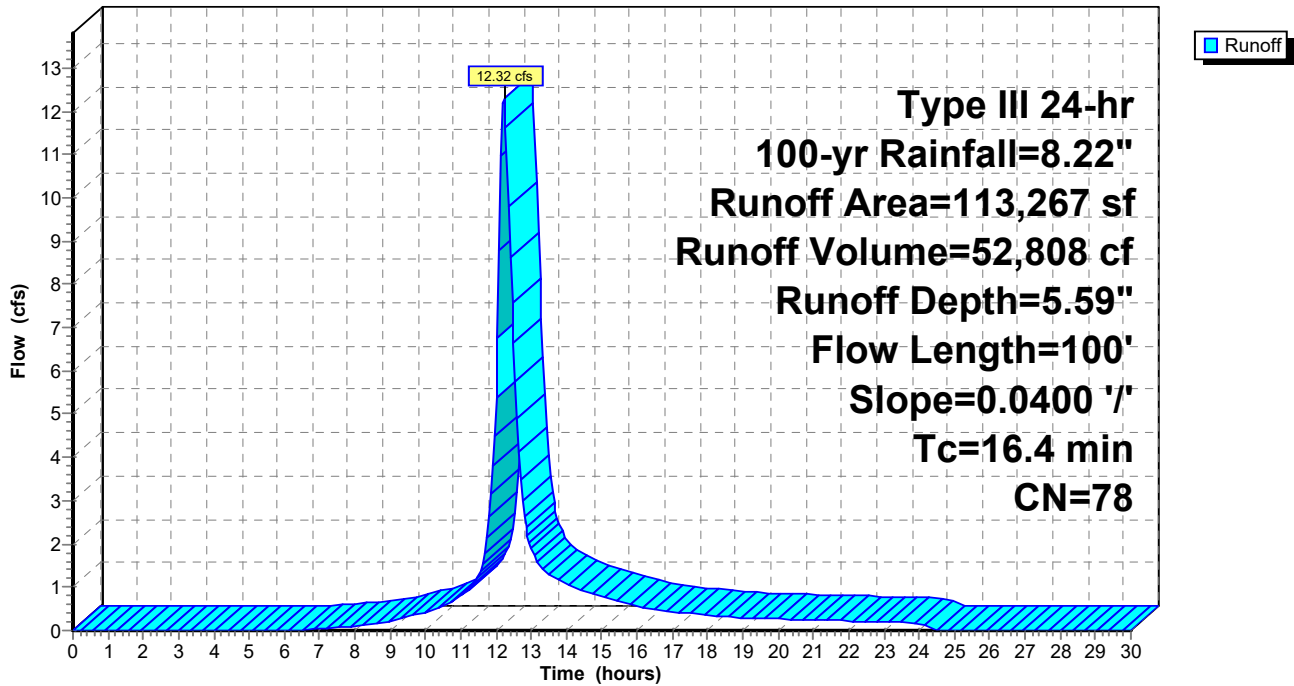

250109 Dewpoint North R3

Prepared by Colliers Engineering & Design

HydroCAD® 10.20-5c s/n 04431 © 2023 HydroCAD Software Solutions LLC

Type III 24-hr 100-yr Rainfall=8.22"

Printed 1/23/2025

Page 54

Summary for Subcatchment PW1B1: DRIVEWAY

Runoff = 4.50 cfs @ 12.09 hrs, Volume= 15,519 cf, Depth= 7.26"
 Routed to Pond 1B : BIO-1B

Runoff by SCS TR-20 method, UH=SCS, Weighted-CN, Time Span= 0.00-30.00 hrs, dt= 0.05 hrs
 Type III 24-hr 100-yr Rainfall=8.22"

Area (sf)	CN	Description
17,549	98	Paved parking, HSG D
8,097	80	>75% Grass cover, Good, HSG D
25,646	92	Weighted Average
8,097		31.57% Pervious Area
17,549		68.43% Impervious Area

Tc (min)	Length (feet)	Slope (ft/ft)	Velocity (ft/sec)	Capacity (cfs)	Description
6.0					Direct Entry,

Subcatchment PW1B1: DRIVEWAY

Hydrograph

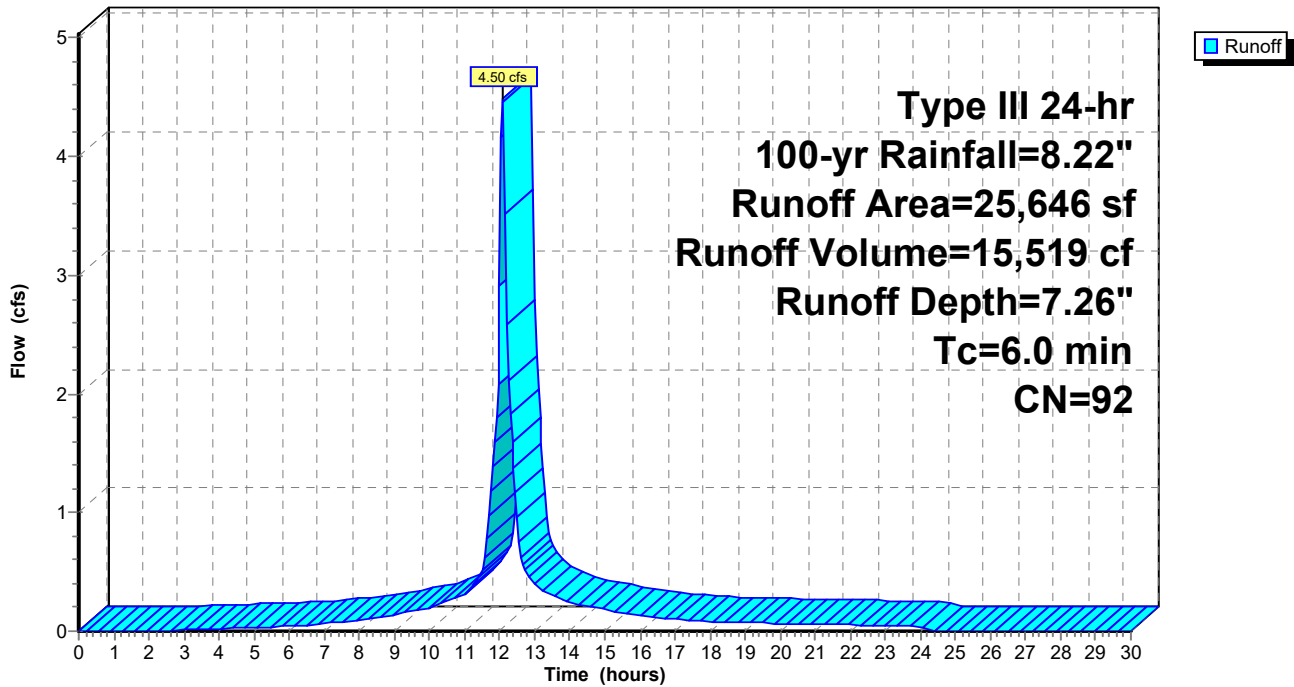

250109 Dewpoint North R3

Prepared by Colliers Engineering & Design

HydroCAD® 10.20-5c s/n 04431 © 2023 HydroCAD Software Solutions LLC

Type III 24-hr 100-yr Rainfall=8.22"

Printed 1/23/2025

Page 55

Summary for Subcatchment PW1B2: 1/2 ROOF

Runoff = 2.89 cfs @ 12.09 hrs, Volume= 10,640 cf, Depth= 7.98"

Routed to Pond 2P : DIVERSION

Runoff by SCS TR-20 method, UH=SCS, Weighted-CN, Time Span= 0.00-30.00 hrs, dt= 0.05 hrs
 Type III 24-hr 100-yr Rainfall=8.22"

Area (sf)	CN	Description
* 16,000	98	
16,000		100.00% Impervious Area

Tc (min)	Length (feet)	Slope (ft/ft)	Velocity (ft/sec)	Capacity (cfs)	Description
6.0					Direct Entry,

Subcatchment PW1B2: 1/2 ROOF

Hydrograph

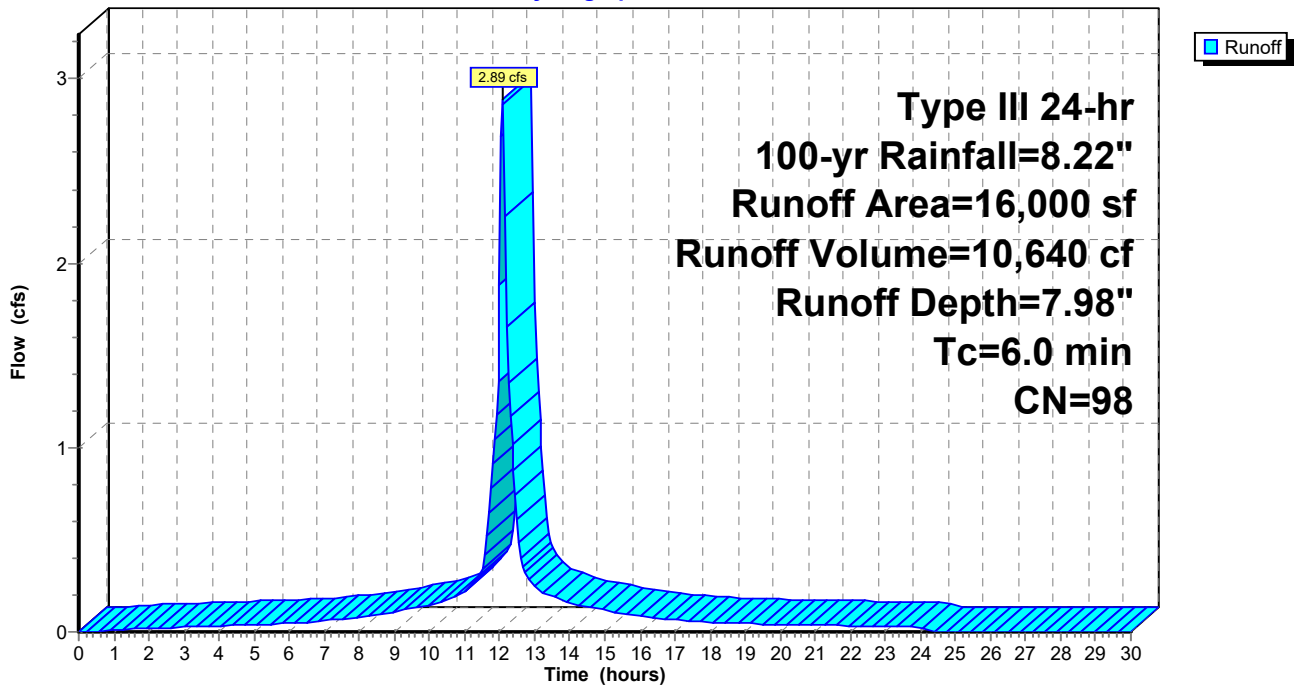

250109 Dewpoint North R3

Prepared by Colliers Engineering & Design

HydroCAD® 10.20-5c s/n 04431 © 2023 HydroCAD Software Solutions LLC

Type III 24-hr 100-yr Rainfall=8.22"

Printed 1/23/2025

Page 56

Summary for Subcatchment PW1C: PW1C

Runoff = 2.63 cfs @ 12.09 hrs, Volume= 8,926 cf, Depth= 7.02"
 Routed to Pond 1C : BIO-1C

Runoff by SCS TR-20 method, UH=SCS, Weighted-CN, Time Span= 0.00-30.00 hrs, dt= 0.05 hrs
 Type III 24-hr 100-yr Rainfall=8.22"

Area (sf)	CN	Description
8,081	98	Paved parking, HSG D
7,173	80	>75% Grass cover, Good, HSG D
15,254	90	Weighted Average
7,173		47.02% Pervious Area
8,081		52.98% Impervious Area

Tc (min)	Length (feet)	Slope (ft/ft)	Velocity (ft/sec)	Capacity (cfs)	Description
6.0					Direct Entry,

Subcatchment PW1C: PW1C

Hydrograph

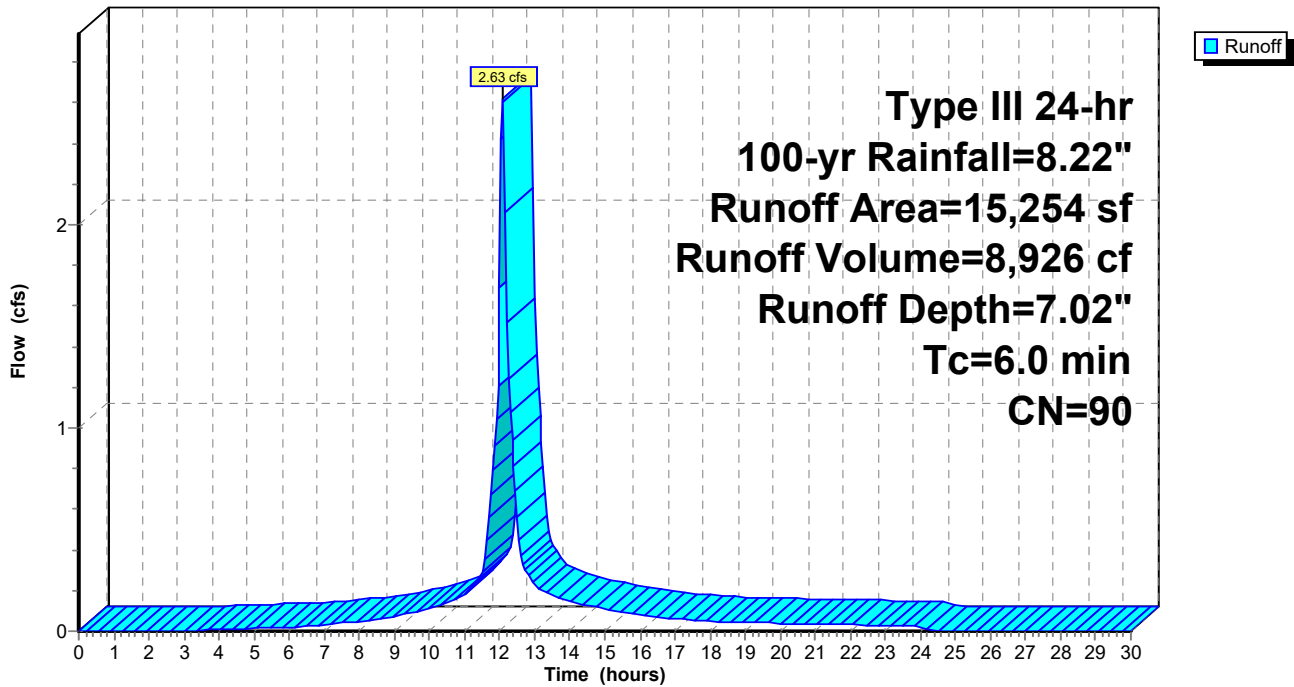

250109 Dewpoint North R3

Prepared by Colliers Engineering & Design

HydroCAD® 10.20-5c s/n 04431 © 2023 HydroCAD Software Solutions LLC

Type III 24-hr 100-yr Rainfall=8.22"

Printed 1/23/2025

Page 57

Summary for Subcatchment PW1D: PAVEMENT

Runoff = 7.18 cfs @ 12.09 hrs, Volume= 25,227 cf, Depth= 7.50"
 Routed to Pond 1D : BIO-1D

Runoff by SCS TR-20 method, UH=SCS, Weighted-CN, Time Span= 0.00-30.00 hrs, dt= 0.05 hrs
 Type III 24-hr 100-yr Rainfall=8.22"

Area (sf)	CN	Description
30,875	98	Paved parking, HSG D
9,484	80	>75% Grass cover, Good, HSG D
40,359	94	Weighted Average
9,484		23.50% Pervious Area
30,875		76.50% Impervious Area

Tc (min)	Length (feet)	Slope (ft/ft)	Velocity (ft/sec)	Capacity (cfs)	Description
6.0					Direct Entry,

Subcatchment PW1D: PAVEMENT

Hydrograph

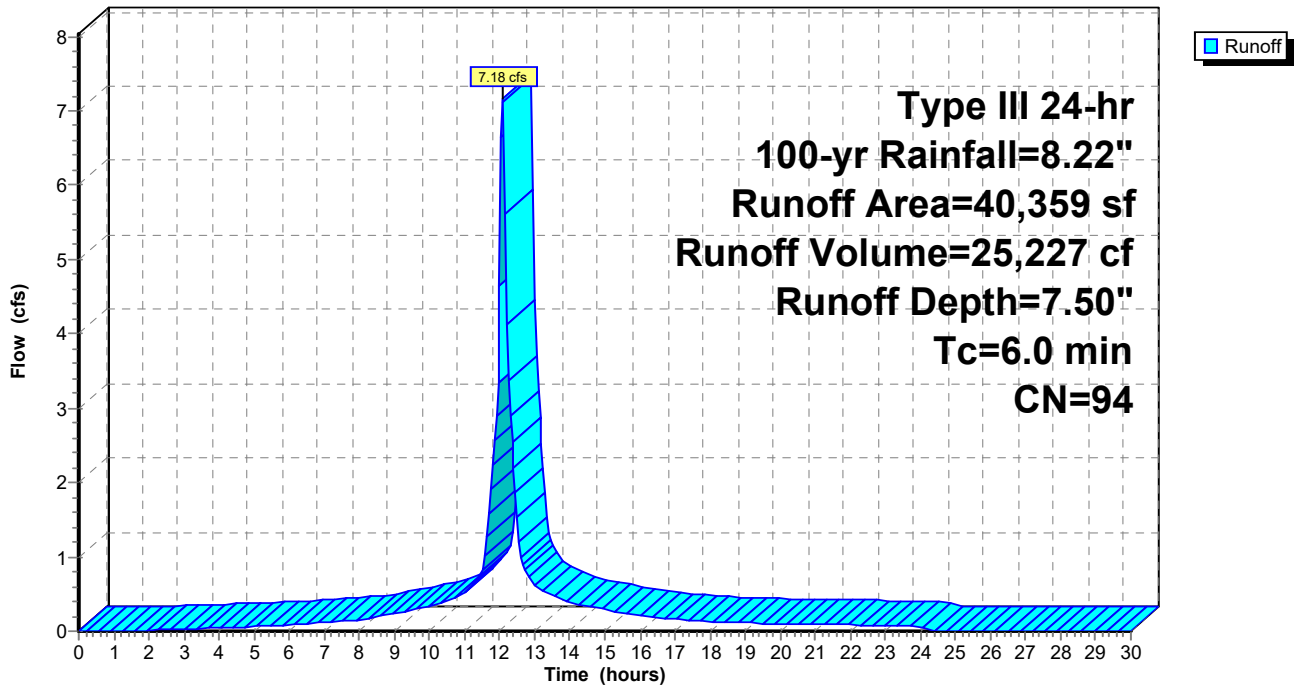

250109 Dewpoint North R3

Prepared by Colliers Engineering & Design

HydroCAD® 10.20-5c s/n 04431 © 2023 HydroCAD Software Solutions LLC

Type III 24-hr 100-yr Rainfall=8.22"

Printed 1/23/2025

Page 58

Summary for Subcatchment PW1E: LOADING

Runoff = 1.59 cfs @ 12.09 hrs, Volume= 5,405 cf, Depth= 7.02"
 Routed to Pond 1E : BIO-1E

Runoff by SCS TR-20 method, UH=SCS, Weighted-CN, Time Span= 0.00-30.00 hrs, dt= 0.05 hrs
 Type III 24-hr 100-yr Rainfall=8.22"

Area (sf)	CN	Description
5,385	98	Paved parking, HSG D
3,851	80	>75% Grass cover, Good, HSG D
9,236	90	Weighted Average
3,851		41.70% Pervious Area
5,385		58.30% Impervious Area

Tc (min)	Length (feet)	Slope (ft/ft)	Velocity (ft/sec)	Capacity (cfs)	Description
6.0					Direct Entry,

Subcatchment PW1E: LOADING

Hydrograph

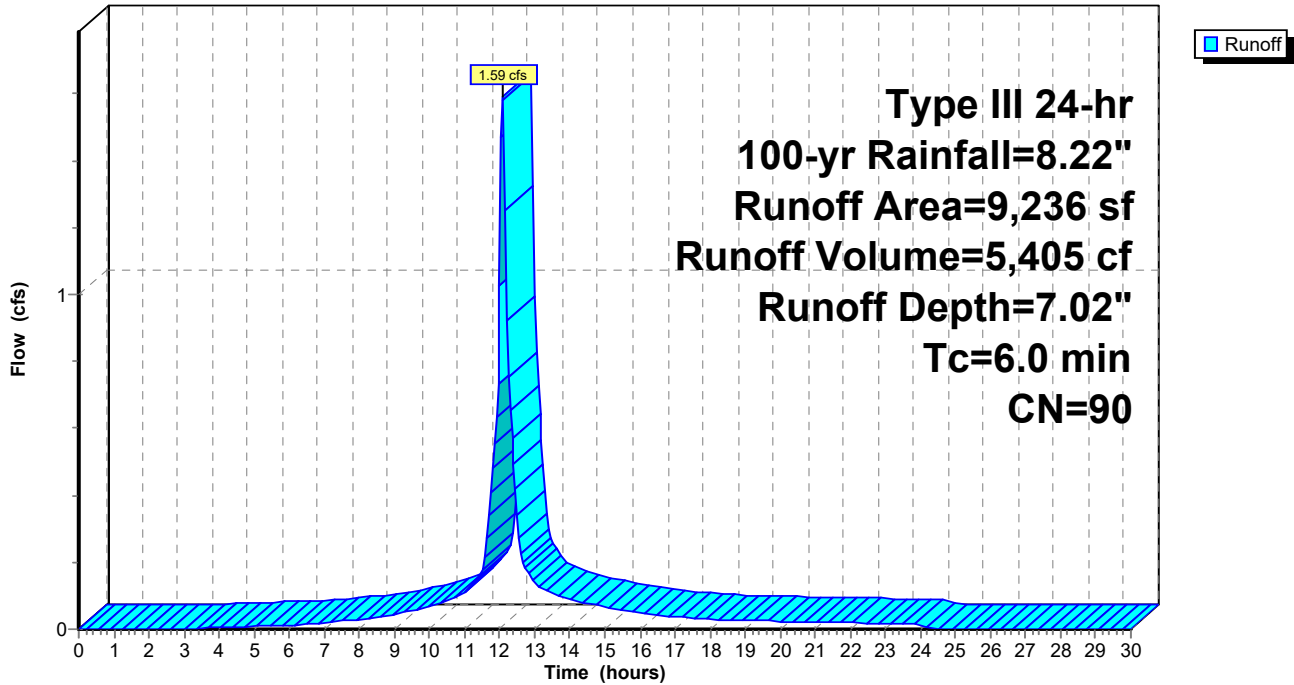

250109 Dewpoint North R3

Prepared by Colliers Engineering & Design

HydroCAD® 10.20-5c s/n 04431 © 2023 HydroCAD Software Solutions LLC

Type III 24-hr 100-yr Rainfall=8.22"

Printed 1/23/2025

Page 59

Summary for Subcatchment PW1F: FIRE LANE

Runoff = 0.80 cfs @ 12.09 hrs, Volume= 2,791 cf, Depth= 7.38"
 Routed to Pond 1F : BIO-1F

Runoff by SCS TR-20 method, UH=SCS, Weighted-CN, Time Span= 0.00-30.00 hrs, dt= 0.05 hrs
 Type III 24-hr 100-yr Rainfall=8.22"

Area (sf)	CN	Description
3,269	98	Paved parking, HSG D
1,268	80	>75% Grass cover, Good, HSG D
4,537	93	Weighted Average
1,268		27.95% Pervious Area
3,269		72.05% Impervious Area

Tc (min)	Length (feet)	Slope (ft/ft)	Velocity (ft/sec)	Capacity (cfs)	Description
6.0					Direct Entry,

Subcatchment PW1F: FIRE LANE

Hydrograph

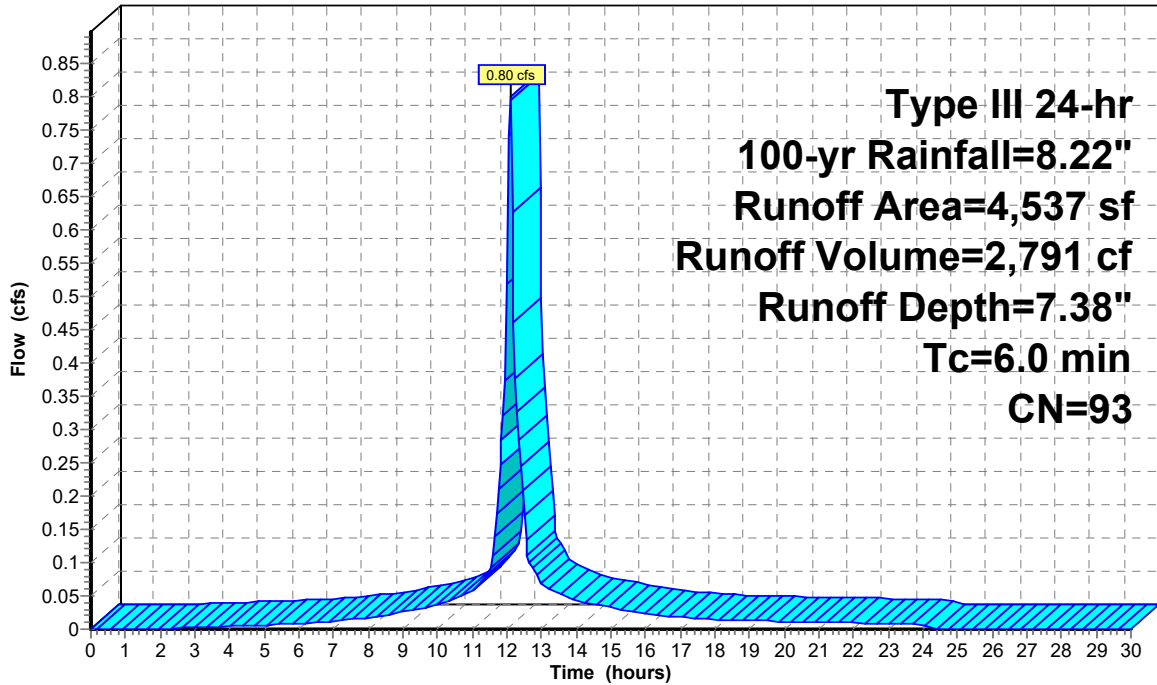

Runoff

250109 Dewpoint North R3

Type III 24-hr 100-yr Rainfall=8.22"

Prepared by Colliers Engineering & Design

Printed 1/23/2025

HydroCAD® 10.20-5c s/n 04431 © 2023 HydroCAD Software Solutions LLC

Page 60

Summary for Pond 1B: BIO-1B

Inflow Area = 25,646 sf, 68.43% Impervious, Inflow Depth = 7.83" for 100-yr event
 Inflow = 6.20 cfs @ 12.09 hrs, Volume= 16,733 cf
 Outflow = 0.67 cfs @ 12.58 hrs, Volume= 16,418 cf, Atten= 89%, Lag= 29.9 min
 Primary = 0.67 cfs @ 12.58 hrs, Volume= 16,418 cf
 Routed to Link PR : DP1 (PROPOSED)

Routing by Dyn-Stor-Ind method, Time Span= 0.00-30.00 hrs, dt= 0.05 hrs
 Peak Elev= 476.77' @ 12.58 hrs Surf.Area= 3,720 sf Storage= 7,856 cf

Plug-Flow detention time= 149.1 min calculated for 16,391 cf (98% of inflow)
 Center-of-Mass det. time= 137.7 min (903.0 - 765.3)

Volume	Invert	Avail.Storage	Storage Description		
#1	474.00'	12,985 cf	Custom Stage Data (Pyramidal) Listed below (Recalc)		
Elevation (feet)	Surf.Area (sq-ft)	Inc.Store (cubic-feet)	Cum.Store (cubic-feet)	Wet.Area (sq-ft)	
474.00	2,038	0	0	2,038	
478.00	4,629	12,985	12,985	4,783	

Device	Routing	Invert	Outlet Devices	
#1	Device 4	477.60'	16.0' long x 0.5' breadth Broad-Crested Rectangular Weir Head (feet) 0.20 0.40 0.60 0.80 1.00 Coef. (English) 2.80 2.92 3.08 3.30 3.32	
#2	Device 4	474.20'	4.0" Vert. Orifice/Grate C= 0.600 Limited to weir flow at low heads	
#3	Device 4	474.00'	0.250 in/hr BIO MEDIA over Surface area	
#4	Primary	470.50'	18.0" Round Culvert L= 17.8' CMP, square edge headwall, Ke= 0.500 Inlet / Outlet Invert= 470.50' / 470.14' S= 0.0202 '/' Cc= 0.900 n= 0.013 Corrugated PE, smooth interior, Flow Area= 1.77 sf	

Primary OutFlow Max=0.67 cfs @ 12.58 hrs HW=476.77' TW=0.00' (Dynamic Tailwater)

- ↑ **4=Culvert** (Passes 0.67 cfs of 19.99 cfs potential flow)
- ↑ **1=Broad-Crested Rectangular Weir** (Controls 0.00 cfs)
- ↑ **2=Orifice/Grate** (Orifice Controls 0.65 cfs @ 7.46 fps)
- ↑ **3=BIO MEDIA** (Exfiltration Controls 0.02 cfs)

Pond 1B: BIO-1B

Hydrograph

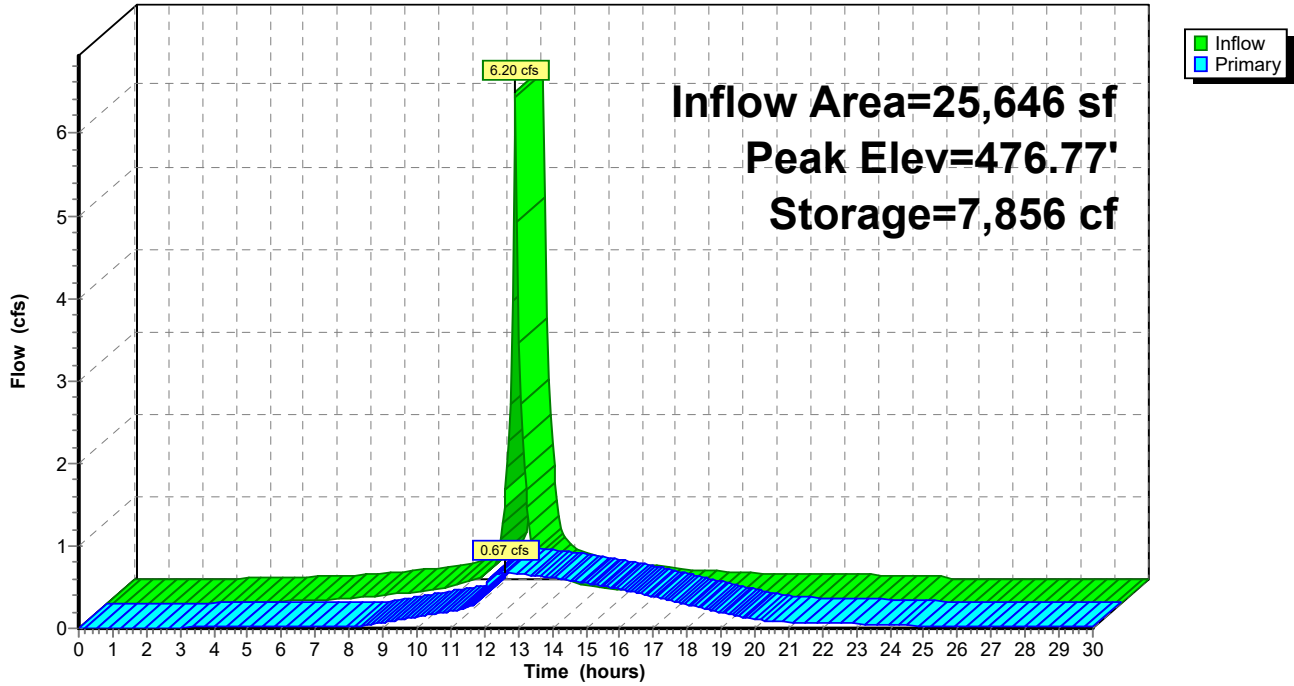

250109 Dewpoint North R3

Type III 24-hr 100-yr Rainfall=8.22"

Prepared by Colliers Engineering & Design

Printed 1/23/2025

HydroCAD® 10.20-5c s/n 04431 © 2023 HydroCAD Software Solutions LLC

Page 62

Stage-Area-Storage for Pond 1B: BIO-1B

Elevation (feet)	Surface (sq-ft)	Storage (cubic-feet)	Elevation (feet)	Surface (sq-ft)	Storage (cubic-feet)
474.00	2,038	0	476.60	3,603	7,237
474.05	2,064	103	476.65	3,637	7,418
474.10	2,090	206	476.70	3,672	7,601
474.15	2,116	312	476.75	3,707	7,785
474.20	2,143	418	476.80	3,742	7,972
474.25	2,169	526	476.85	3,777	8,160
474.30	2,196	635	476.90	3,812	8,349
474.35	2,223	745	476.95	3,847	8,541
474.40	2,250	857	477.00	3,883	8,734
474.45	2,277	970	477.05	3,919	8,929
474.50	2,305	1,085	477.10	3,955	9,126
474.55	2,332	1,201	477.15	3,991	9,325
474.60	2,360	1,318	477.20	4,027	9,525
474.65	2,388	1,437	477.25	4,063	9,727
474.70	2,416	1,557	477.30	4,100	9,931
474.75	2,444	1,678	477.35	4,137	10,137
474.80	2,472	1,801	477.40	4,174	10,345
474.85	2,501	1,926	477.45	4,211	10,555
474.90	2,530	2,051	477.50	4,248	10,766
474.95	2,558	2,179	477.55	4,285	10,979
475.00	2,587	2,307	477.60	4,323	11,195
475.05	2,617	2,437	477.65	4,360	11,412
475.10	2,646	2,569	477.70	4,398	11,631
475.15	2,676	2,702	477.75	4,436	11,852
475.20	2,705	2,837	477.80	4,475	12,074
475.25	2,735	2,973	477.85	4,513	12,299
475.30	2,765	3,110	477.90	4,551	12,526
475.35	2,795	3,249	477.95	4,590	12,754
475.40	2,826	3,390	478.00	4,629	12,985
475.45	2,856	3,532			
475.50	2,887	3,675			
475.55	2,918	3,820			
475.60	2,949	3,967			
475.65	2,980	4,115			
475.70	3,011	4,265			
475.75	3,043	4,416			
475.80	3,074	4,569			
475.85	3,106	4,724			
475.90	3,138	4,880			
475.95	3,170	5,037			
476.00	3,202	5,197			
476.05	3,235	5,358			
476.10	3,268	5,520			
476.15	3,300	5,685			
476.20	3,333	5,850			
476.25	3,366	6,018			
476.30	3,400	6,187			
476.35	3,433	6,358			
476.40	3,467	6,530			
476.45	3,501	6,705			
476.50	3,535	6,880			
476.55	3,569	7,058			

250109 Dewpoint North R3

Type III 24-hr 100-yr Rainfall=8.22"

Prepared by Colliers Engineering & Design

Printed 1/23/2025

HydroCAD® 10.20-5c s/n 04431 © 2023 HydroCAD Software Solutions LLC

Page 63

Summary for Pond 1C: BIO-1C

Inflow Area = 15,254 sf, 52.98% Impervious, Inflow Depth = 7.02" for 100-yr event
 Inflow = 2.63 cfs @ 12.09 hrs, Volume= 8,926 cf
 Outflow = 2.59 cfs @ 12.11 hrs, Volume= 8,671 cf, Atten= 2%, Lag= 1.1 min
 Primary = 2.59 cfs @ 12.11 hrs, Volume= 8,671 cf
 Routed to Pond 1D : BIO-1D

Routing by Dyn-Stor-Ind method, Time Span= 0.00-30.00 hrs, dt= 0.05 hrs
 Peak Elev= 495.45' @ 12.11 hrs Surf.Area= 1,580 sf Storage= 664 cf

Plug-Flow detention time= 52.4 min calculated for 8,657 cf (97% of inflow)
 Center-of-Mass det. time= 35.8 min (810.9 - 775.1)

Volume	Invert	Avail.Storage	Storage Description		
#1	495.00'	2,593 cf	Custom Stage Data (Pyramidal) listed below (Recalc)		
Elevation (feet)	Surf.Area (sq-ft)	Inc.Store (cubic-feet)	Cum.Store (cubic-feet)	Wet.Area (sq-ft)	
495.00	1,379	0	0	1,379	
496.50	2,104	2,593	2,593	2,146	

Device	Routing	Invert	Outlet Devices					
#1	Device 3	495.30'	16.0' long x 0.5' breadth Broad-Crested Rectangular Weir					
			Head (feet) 0.20 0.40 0.60 0.80 1.00					
			Coef. (English) 2.80 2.92 3.08 3.30 3.32					
#2	Device 3	495.00'	0.250 in/hr BIO MEDIA over Surface area					
#3	Primary	491.50'	18.0" Round Culvert L= 82.0' Ke= 0.500					
			Inlet / Outlet Invert= 491.50' / 479.00' S= 0.1524 '/' Cc= 0.900					
			n= 0.013 Corrugated PE, smooth interior, Flow Area= 1.77 sf					

Primary OutFlow Max=2.55 cfs @ 12.11 hrs HW=495.45' TW=480.84' (Dynamic Tailwater)
 3=Culvert (Passes 2.55 cfs of 15.22 cfs potential flow)
 1=Broad-Crested Rectangular Weir (Weir Controls 2.54 cfs @ 1.08 fps)
 2=BIO MEDIA (Exfiltration Controls 0.01 cfs)

Pond 1C: BIO-1C

Hydrograph

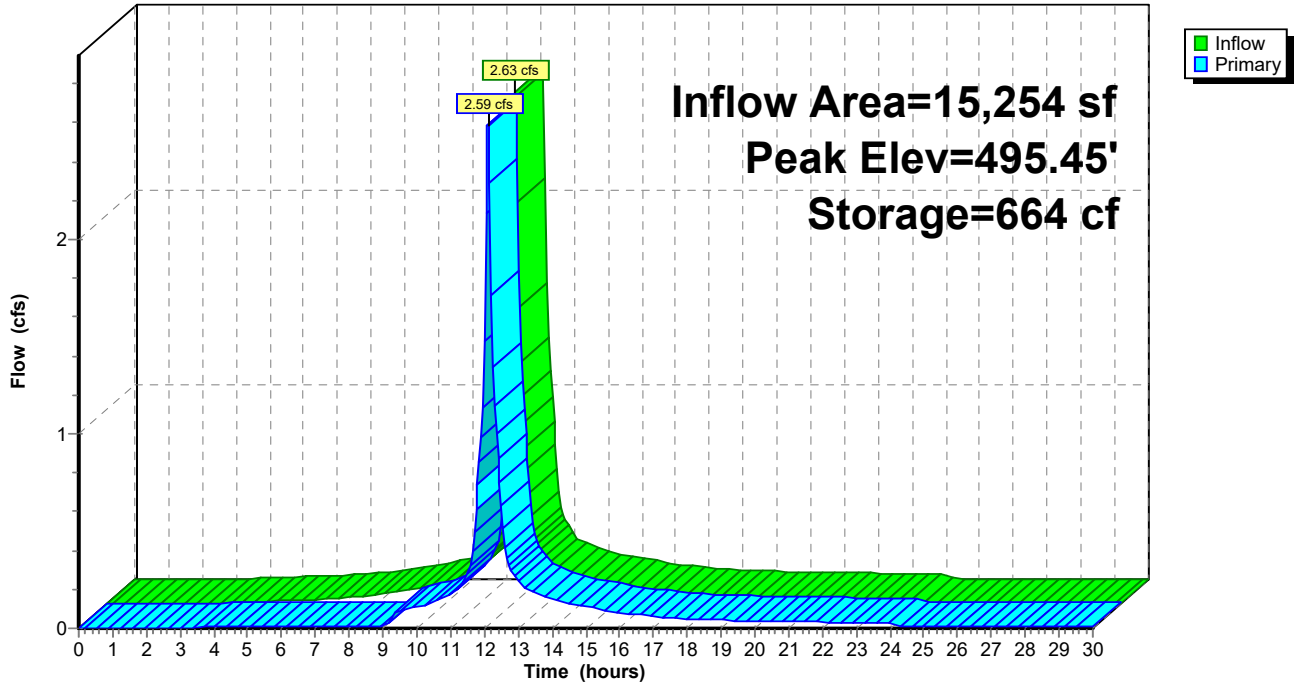

250109 Dewpoint North R3

Type III 24-hr 100-yr Rainfall=8.22"

Prepared by Colliers Engineering & Design

Printed 1/23/2025

HydroCAD® 10.20-5c s/n 04431 © 2023 HydroCAD Software Solutions LLC

Page 65

Stage-Area-Storage for Pond 1C: BIO-1C

Elevation (feet)	Surface (sq-ft)	Storage (cubic-feet)	Elevation (feet)	Surface (sq-ft)	Storage (cubic-feet)
495.00	1,379	0	496.04	1,865	1,681
495.02	1,388	28	496.06	1,876	1,718
495.04	1,396	56	496.08	1,886	1,756
495.06	1,405	84	496.10	1,896	1,794
495.08	1,414	112	496.12	1,906	1,832
495.10	1,423	140	496.14	1,916	1,870
495.12	1,431	169	496.16	1,926	1,908
495.14	1,440	197	496.18	1,937	1,947
495.16	1,449	226	496.20	1,947	1,986
495.18	1,458	255	496.22	1,957	2,025
495.20	1,467	285	496.24	1,967	2,064
495.22	1,476	314	496.26	1,978	2,103
495.24	1,485	344	496.28	1,988	2,143
495.26	1,494	373	496.30	1,999	2,183
495.28	1,503	403	496.32	2,009	2,223
495.30	1,512	433	496.34	2,019	2,263
495.32	1,521	464	496.36	2,030	2,304
495.34	1,530	494	496.38	2,040	2,345
495.36	1,539	525	496.40	2,051	2,385
495.38	1,548	556	496.42	2,061	2,427
495.40	1,557	587	496.44	2,072	2,468
495.42	1,567	618	496.46	2,083	2,509
495.44	1,576	650	496.48	2,093	2,551
495.46	1,585	681	496.50	2,104	2,593
495.48	1,594	713			
495.50	1,604	745			
495.52	1,613	777			
495.54	1,622	809			
495.56	1,632	842			
495.58	1,641	875			
495.60	1,651	908			
495.62	1,660	941			
495.64	1,670	974			
495.66	1,679	1,008			
495.68	1,689	1,041			
495.70	1,698	1,075			
495.72	1,708	1,109			
495.74	1,718	1,143			
495.76	1,727	1,178			
495.78	1,737	1,213			
495.80	1,747	1,247			
495.82	1,756	1,282			
495.84	1,766	1,318			
495.86	1,776	1,353			
495.88	1,786	1,389			
495.90	1,796	1,424			
495.92	1,806	1,461			
495.94	1,815	1,497			
495.96	1,825	1,533			
495.98	1,835	1,570			
496.00	1,845	1,607			
496.02	1,855	1,644			

250109 Dewpoint North R3

Type III 24-hr 100-yr Rainfall=8.22"

Prepared by Colliers Engineering & Design

Printed 1/23/2025

HydroCAD® 10.20-5c s/n 04431 © 2023 HydroCAD Software Solutions LLC

Page 66

Summary for Pond 1D: BIO-1D

Inflow Area = 71,613 sf, 76.74% Impervious, Inflow Depth > 7.26" for 100-yr event
 Inflow = 10.92 cfs @ 12.09 hrs, Volume= 43,324 cf
 Outflow = 7.67 cfs @ 12.19 hrs, Volume= 36,707 cf, Atten= 30%, Lag= 6.0 min
 Primary = 7.67 cfs @ 12.19 hrs, Volume= 36,707 cf
 Routed to Link PR : DP1 (PROPOSED)

Routing by Dyn-Stor-Ind method, Time Span= 0.00-30.00 hrs, dt= 0.05 hrs
 Peak Elev= 480.93' @ 12.19 hrs Surf.Area= 8,003 sf Storage= 14,358 cf

Plug-Flow detention time= 150.0 min calculated for 36,707 cf (85% of inflow)
 Center-of-Mass det. time= 81.3 min (848.1 - 766.9)

Volume	Invert	Avail.Storage	Storage Description		
#1	479.00'	23,267 cf	Custom Stage Data (Pyramidal) Listed below (Recalc)		
Elevation (feet)	Surf.Area (sq-ft)	Inc.Store (cubic-feet)	Cum.Store (cubic-feet)	Wet.Area (sq-ft)	
479.00	6,887	0	0	6,887	
482.00	8,658	23,267	23,267	8,949	

Device	Routing	Invert	Outlet Devices
#1	Device 3	480.75'	16.0' long x 0.5' breadth Broad-Crested Rectangular Weir Head (feet) 0.20 0.40 0.60 0.80 1.00 Coef. (English) 2.80 2.92 3.08 3.30 3.32
#2	Device 3	479.00'	0.250 in/hr BIO MEDIA over Surface area
#3	Primary	475.50'	18.0" Round Culvert L= 22.6' CMP, square edge headwall, Ke= 0.500 Inlet / Outlet Invert= 475.50' / 474.80' S= 0.0310 '/' Cc= 0.900 n= 0.013 Corrugated PE, smooth interior, Flow Area= 1.77 sf
#4	Primary	480.00'	36.0" W x 4.0" H Vert. Orifice/Grate C= 0.600 Limited to weir flow at low heads

Primary OutFlow Max=7.60 cfs @ 12.19 hrs HW=480.93' TW=0.00' (Dynamic Tailwater)

- 3=Culvert (Passes 3.41 cfs of 18.40 cfs potential flow)
- 1=Broad-Crested Rectangular Weir (Weir Controls 3.36 cfs @ 1.18 fps)
- 2=BIO MEDIA (Exfiltration Controls 0.05 cfs)
- 4=Orifice/Grate (Orifice Controls 4.19 cfs @ 4.19 fps)

Pond 1D: BIO-1D

Hydrograph

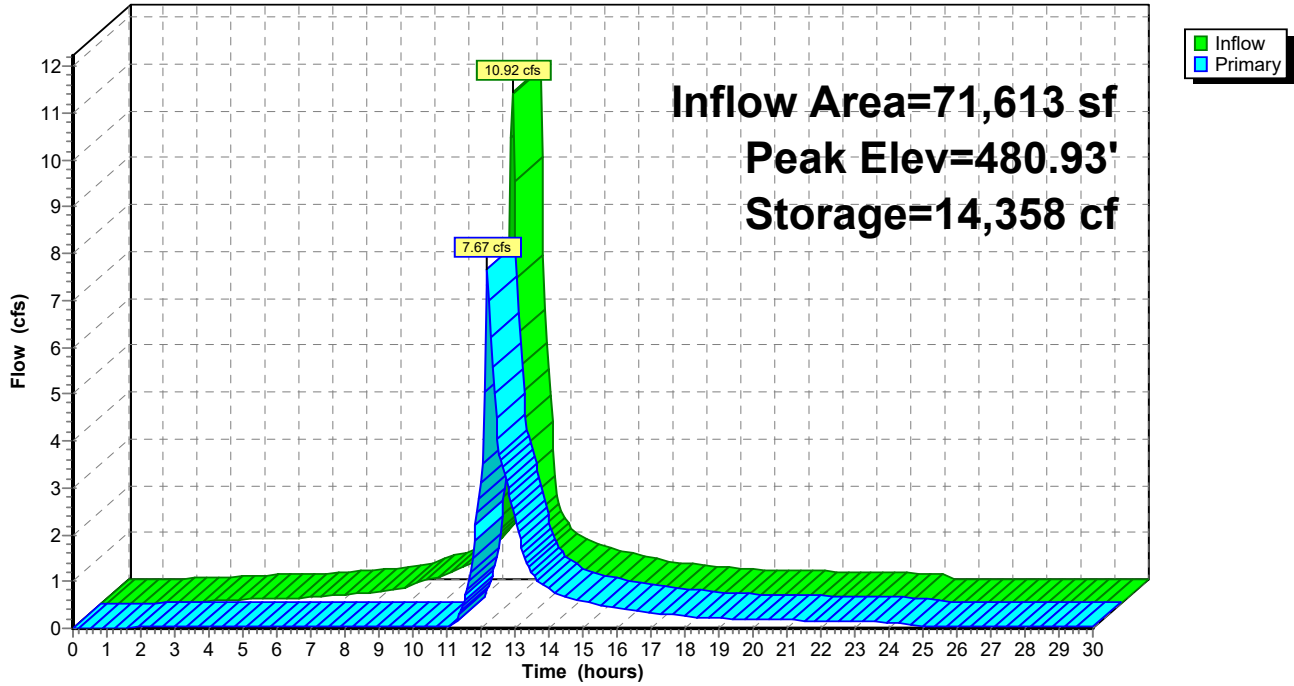

250109 Dewpoint North R3

Type III 24-hr 100-yr Rainfall=8.22"

Prepared by Colliers Engineering & Design

Printed 1/23/2025

HydroCAD® 10.20-5c s/n 04431 © 2023 HydroCAD Software Solutions LLC

Page 68

Stage-Area-Storage for Pond 1D: BIO-1D

Elevation (feet)	Surface (sq-ft)	Storage (cubic-feet)	Elevation (feet)	Surface (sq-ft)	Storage (cubic-feet)
479.00	6,887	0	481.60	8,410	19,853
479.05	6,915	345	481.65	8,441	20,275
479.10	6,943	691	481.70	8,472	20,697
479.15	6,971	1,039	481.75	8,503	21,122
479.20	6,999	1,389	481.80	8,534	21,548
479.25	7,027	1,739	481.85	8,565	21,975
479.30	7,055	2,091	481.90	8,596	22,404
479.35	7,083	2,445	481.95	8,627	22,835
479.40	7,111	2,800	482.00	8,658	23,267
479.45	7,140	3,156			
479.50	7,168	3,514			
479.55	7,197	3,873			
479.60	7,225	4,233			
479.65	7,254	4,595			
479.70	7,282	4,959			
479.75	7,311	5,323			
479.80	7,339	5,690			
479.85	7,368	6,057			
479.90	7,397	6,426			
479.95	7,426	6,797			
480.00	7,455	7,169			
480.05	7,484	7,543			
480.10	7,513	7,917			
480.15	7,542	8,294			
480.20	7,571	8,672			
480.25	7,600	9,051			
480.30	7,630	9,432			
480.35	7,659	9,814			
480.40	7,688	10,198			
480.45	7,718	10,583			
480.50	7,747	10,969			
480.55	7,777	11,357			
480.60	7,806	11,747			
480.65	7,836	12,138			
480.70	7,866	12,531			
480.75	7,895	12,925			
480.80	7,925	13,320			
480.85	7,955	13,717			
480.90	7,985	14,116			
480.95	8,015	14,516			
481.00	8,045	14,917			
481.05	8,075	15,320			
481.10	8,105	15,725			
481.15	8,136	16,131			
481.20	8,166	16,538			
481.25	8,196	16,947			
481.30	8,227	17,358			
481.35	8,257	17,770			
481.40	8,288	18,184			
481.45	8,318	18,599			
481.50	8,349	19,015			
481.55	8,379	19,434			

250109 Dewpoint North R3

Type III 24-hr 100-yr Rainfall=8.22"

Prepared by Colliers Engineering & Design

Printed 1/23/2025

HydroCAD® 10.20-5c s/n 04431 © 2023 HydroCAD Software Solutions LLC

Page 69

Summary for Pond 1E: BIO-1E

Inflow Area = 9,236 sf, 58.30% Impervious, Inflow Depth = 7.02" for 100-yr event
 Inflow = 1.59 cfs @ 12.09 hrs, Volume= 5,405 cf
 Outflow = 0.59 cfs @ 12.34 hrs, Volume= 4,609 cf, Atten= 63%, Lag= 14.9 min
 Primary = 0.59 cfs @ 12.34 hrs, Volume= 4,609 cf
 Routed to Link PR : DP1 (PROPOSED)

Routing by Dyn-Stor-Ind method, Time Span= 0.00-30.00 hrs, dt= 0.05 hrs
 Peak Elev= 491.00' @ 12.34 hrs Surf.Area= 1,463 sf Storage= 2,133 cf

Plug-Flow detention time= 151.4 min calculated for 4,602 cf (85% of inflow)
 Center-of-Mass det. time= 89.4 min (864.5 - 775.1)

Volume	Invert	Avail.Storage	Storage Description		
#1	489.00'	3,828 cf	Custom Stage Data (Pyramidal) Listed below (Recalc)		
Elevation (feet)	Surf.Area (sq-ft)	Inc.Store (cubic-feet)	Cum.Store (cubic-feet)	Wet.Area (sq-ft)	
489.00	715	0	0	715	
492.00	1,936	3,828	3,828	2,008	

Device	Routing	Invert	Outlet Devices	
#1	Device 4	491.00'	16.0' long x 0.5' breadth Broad-Crested Rectangular Weir Head (feet) 0.20 0.40 0.60 0.80 1.00 Coef. (English) 2.80 2.92 3.08 3.30 3.32	
#2	Device 4	490.00'	5.0" Vert. Orifice/Grate C= 0.600 Limited to weir flow at low heads	
#3	Device 4	489.00'	0.250 in/hr BIO MEDIA over Surface area	
#4	Primary	485.50'	12.0" Round Culvert L= 33.0' CMP, square edge headwall, Ke= 0.500 Inlet / Outlet Invert= 485.50' / 480.00' S= 0.1667 '/' Cc= 0.900 n= 0.013 Corrugated PE, smooth interior, Flow Area= 0.79 sf	

Primary OutFlow Max=0.59 cfs @ 12.34 hrs HW=491.00' TW=0.00' (Dynamic Tailwater)

- 4=Culvert (Passes 0.59 cfs of 8.45 cfs potential flow)
- 1=Broad-Crested Rectangular Weir (Controls 0.00 cfs)
- 2=Orifice/Grate (Orifice Controls 0.58 cfs @ 4.28 fps)
- 3=BIO MEDIA (Exfiltration Controls 0.01 cfs)

Pond 1E: BIO-1E

Hydrograph

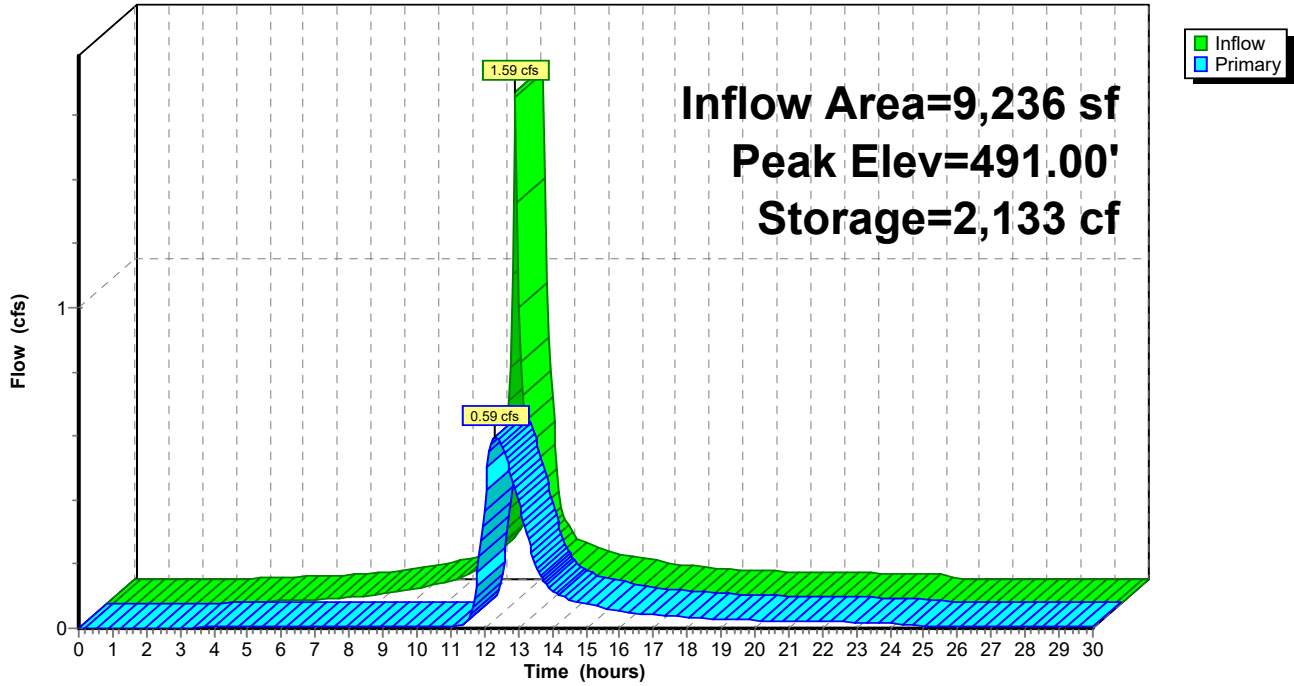

250109 Dewpoint North R3

Type III 24-hr 100-yr Rainfall=8.22"

Prepared by Colliers Engineering & Design

Printed 1/23/2025

HydroCAD® 10.20-5c s/n 04431 © 2023 HydroCAD Software Solutions LLC

Page 71

Stage-Area-Storage for Pond 1E: BIO-1E

Elevation (feet)	Surface (sq-ft)	Storage (cubic-feet)	Elevation (feet)	Surface (sq-ft)	Storage (cubic-feet)
489.00	715	0	491.60	1,739	3,093
489.05	730	36	491.65	1,763	3,180
489.10	746	73	491.70	1,787	3,269
489.15	762	111	491.75	1,811	3,359
489.20	778	149	491.80	1,836	3,450
489.25	794	189	491.85	1,861	3,543
489.30	810	229	491.90	1,886	3,636
489.35	827	270	491.95	1,911	3,731
489.40	843	311	492.00	1,936	3,828
489.45	860	354			
489.50	877	397			
489.55	894	442			
489.60	912	487			
489.65	929	533			
489.70	947	580			
489.75	964	627			
489.80	982	676			
489.85	1,000	726			
489.90	1,019	776			
489.95	1,037	828			
490.00	1,056	880			
490.05	1,075	933			
490.10	1,094	987			
490.15	1,113	1,042			
490.20	1,132	1,099			
490.25	1,151	1,156			
490.30	1,171	1,214			
490.35	1,191	1,273			
490.40	1,211	1,333			
490.45	1,231	1,394			
490.50	1,251	1,456			
490.55	1,271	1,519			
490.60	1,292	1,583			
490.65	1,313	1,648			
490.70	1,334	1,714			
490.75	1,355	1,782			
490.80	1,376	1,850			
490.85	1,398	1,919			
490.90	1,419	1,990			
490.95	1,441	2,061			
491.00	1,463	2,134			
491.05	1,485	2,207			
491.10	1,507	2,282			
491.15	1,530	2,358			
491.20	1,552	2,435			
491.25	1,575	2,513			
491.30	1,598	2,593			
491.35	1,621	2,673			
491.40	1,644	2,755			
491.45	1,668	2,837			
491.50	1,691	2,921			
491.55	1,715	3,007			

250109 Dewpoint North R3

Type III 24-hr 100-yr Rainfall=8.22"

Prepared by Colliers Engineering & Design

Printed 1/23/2025

HydroCAD® 10.20-5c s/n 04431 © 2023 HydroCAD Software Solutions LLC

Page 72

Summary for Pond 1F: BIO-1F

Inflow Area = 4,537 sf, 72.05% Impervious, Inflow Depth = 7.38" for 100-yr event
 Inflow = 0.80 cfs @ 12.09 hrs, Volume= 2,791 cf
 Outflow = 0.79 cfs @ 12.10 hrs, Volume= 2,404 cf, Atten= 1%, Lag= 0.9 min
 Primary = 0.79 cfs @ 12.10 hrs, Volume= 2,404 cf
 Routed to Link PR : DP1 (PROPOSED)

Routing by Dyn-Stor-Ind method, Time Span= 0.00-30.00 hrs, dt= 0.05 hrs
 Peak Elev= 482.10' @ 12.10 hrs Surf.Area= 609 sf Storage= 514 cf

Plug-Flow detention time= 129.1 min calculated for 2,404 cf (86% of inflow)
 Center-of-Mass det. time= 68.0 min (832.7 - 764.7)

Volume	Invert	Avail.Storage	Storage Description		
#1	481.00'	781 cf	Custom Stage Data (Pyramidal) Listed below (Recalc)		
Elevation (feet)	Surf.Area (sq-ft)	Inc.Store (cubic-feet)	Cum.Store (cubic-feet)	Wet.Area (sq-ft)	
481.00	339	0	0	339	
482.50	727	781	781	750	

Device	Routing	Invert	Outlet Devices									
#1	Primary	482.00'	10.0' long x 10.0' breadth Broad-Crested Rectangular Weir									
			Head (feet) 0.20 0.40 0.60 0.80 1.00 1.20 1.40 1.60									
			Coef. (English) 2.49 2.56 2.70 2.69 2.68 2.69 2.67 2.64									
#2	Primary	481.00'	0.250 in/hr BIO MEDIA over Surface area									

Primary OutFlow Max=0.79 cfs @ 12.10 hrs HW=482.10' TW=0.00' (Dynamic Tailwater)

- 1=Broad-Crested Rectangular Weir (Weir Controls 0.79 cfs @ 0.79 fps)
- 2=BIO MEDIA (Exfiltration Controls 0.00 cfs)

Pond 1F: BIO-1F

Hydrograph

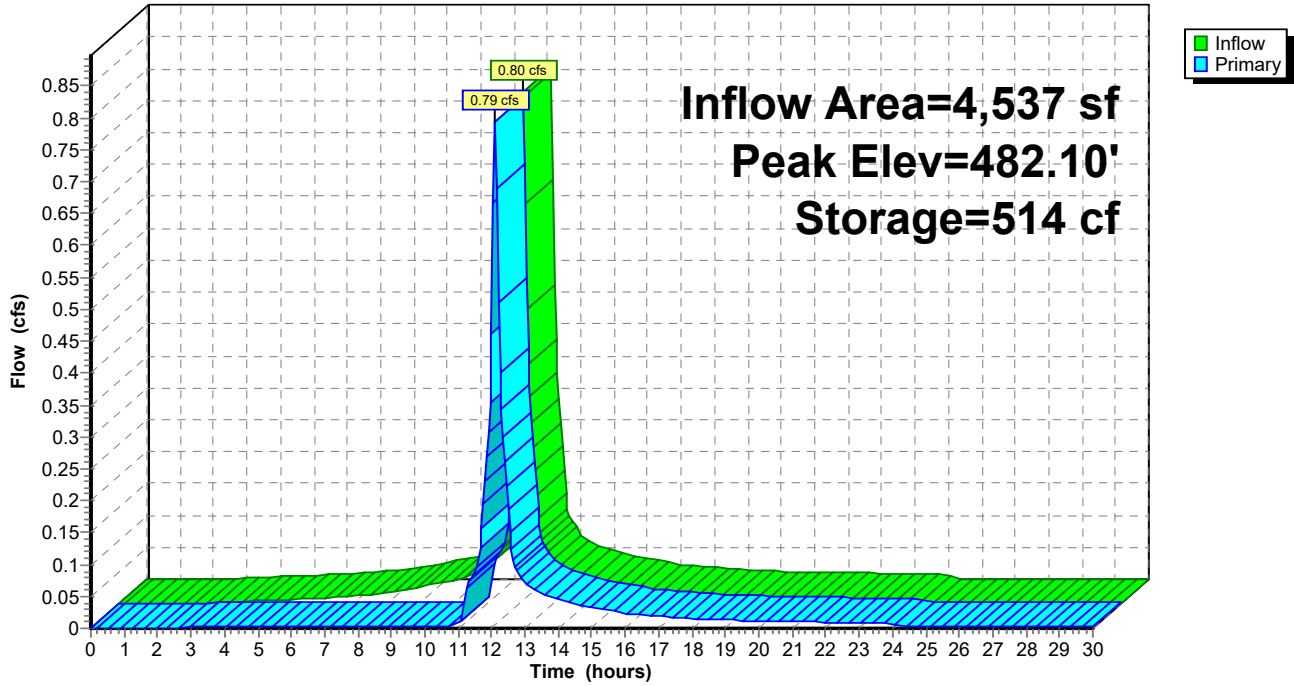

250109 Dewpoint North R3

Type III 24-hr 100-yr Rainfall=8.22"

Prepared by Colliers Engineering & Design

Printed 1/23/2025

HydroCAD® 10.20-5c s/n 04431 © 2023 HydroCAD Software Solutions LLC

Page 74

Stage-Area-Storage for Pond 1F: BIO-1F

Elevation (feet)	Surface (sq-ft)	Storage (cubic-feet)	Elevation (feet)	Surface (sq-ft)	Storage (cubic-feet)
481.00	339	0	482.04	592	478
481.02	343	7	482.06	598	490
481.04	347	14	482.08	604	502
481.06	352	21	482.10	609	514
481.08	356	28	482.12	615	527
481.10	360	35	482.14	621	539
481.12	365	42	482.16	626	551
481.14	369	50	482.18	632	564
481.16	373	57	482.20	638	577
481.18	378	64	482.22	643	589
481.20	382	72	482.24	649	602
481.22	387	80	482.26	655	615
481.24	391	88	482.28	661	629
481.26	396	95	482.30	667	642
481.28	400	103	482.32	673	655
481.30	405	111	482.34	679	669
481.32	410	120	482.36	685	682
481.34	414	128	482.38	691	696
481.36	419	136	482.40	697	710
481.38	423	145	482.42	703	724
481.40	428	153	482.44	709	738
481.42	433	162	482.46	715	752
481.44	438	170	482.48	721	767
481.46	442	179	482.50	727	781
481.48	447	188			
481.50	452	197			
481.52	457	206			
481.54	462	215			
481.56	467	225			
481.58	472	234			
481.60	477	244			
481.62	482	253			
481.64	487	263			
481.66	492	273			
481.68	497	282			
481.70	502	292			
481.72	507	303			
481.74	512	313			
481.76	517	323			
481.78	523	333			
481.80	528	344			
481.82	533	355			
481.84	538	365			
481.86	544	376			
481.88	549	387			
481.90	554	398			
481.92	560	409			
481.94	565	420			
481.96	570	432			
481.98	576	443			
482.00	581	455			
482.02	587	466			

250109 Dewpoint North R3

Prepared by Colliers Engineering & Design

HydroCAD® 10.20-5c s/n 04431 © 2023 HydroCAD Software Solutions LLC

Type III 24-hr 100-yr Rainfall=8.22"

Printed 1/23/2025

Page 75

Summary for Pond 2P: DIVERSION

Inflow Area = 16,000 sf, 100.00% Impervious, Inflow Depth = 7.98" for 100-yr event
 Inflow = 2.89 cfs @ 12.09 hrs, Volume= 10,640 cf
 Outflow = 2.89 cfs @ 12.09 hrs, Volume= 10,640 cf, Atten= 0%, Lag= 0.0 min
 Primary = 1.19 cfs @ 12.09 hrs, Volume= 9,426 cf
 Routed to Pond 1D : BIO-1D
 Secondary = 1.70 cfs @ 12.09 hrs, Volume= 1,214 cf
 Routed to Pond 1B : BIO-1B

Routing by Dyn-Stor-Ind method, Time Span= 0.00-30.00 hrs, dt= 0.05 hrs
 Peak Elev= 489.84' @ 12.09 hrs

Device	Routing	Invert	Outlet Devices
#1	Primary	488.00'	6.0" Round Culvert L= 12.0' CMP, square edge headwall, Ke= 0.500 Inlet / Outlet Invert= 488.00' / 486.00' S= 0.1667 ' S= 0.1667 ' Cc= 0.900 n= 0.013 Corrugated PE, smooth interior, Flow Area= 0.20 sf
#2	Secondary	489.20'	15.0" Round Culvert L= 250.0' Ke= 0.500 Inlet / Outlet Invert= 489.20' / 470.00' S= 0.0768 ' S= 0.0768 ' Cc= 0.900 n= 0.013 Corrugated PE, smooth interior, Flow Area= 1.23 sf

Primary OutFlow Max=1.18 cfs @ 12.09 hrs HW=489.82' TW=480.79' (Dynamic Tailwater)
 ↳1=Culvert (Inlet Controls 1.18 cfs @ 6.03 fps)

Secondary OutFlow Max=1.63 cfs @ 12.09 hrs HW=489.82' TW=475.90' (Dynamic Tailwater)
 ↳2=Culvert (Inlet Controls 1.63 cfs @ 2.68 fps)

Pond 2P: DIVERSION

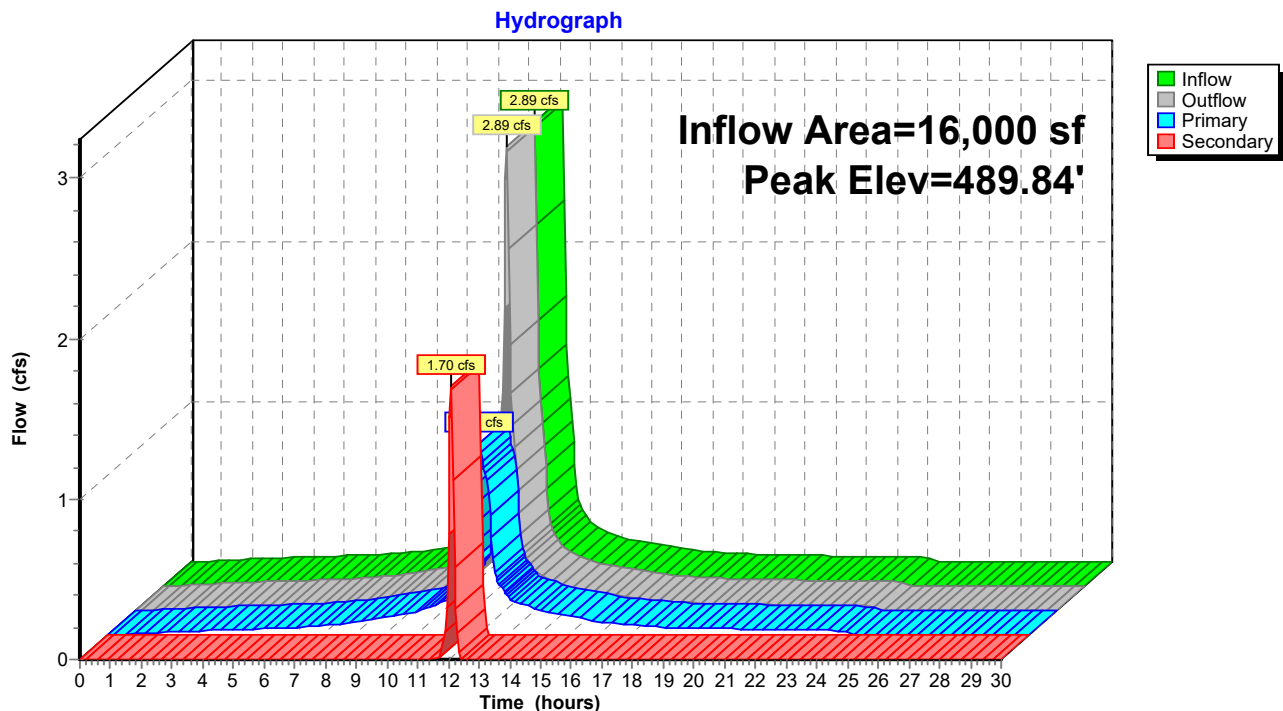

250109 Dewpoint North R3

Type III 24-hr 100-yr Rainfall=8.22"

Prepared by Colliers Engineering & Design

Printed 1/23/2025

HydroCAD® 10.20-5c s/n 04431 © 2023 HydroCAD Software Solutions LLC

Page 76

Stage-Area-Storage for Pond 2P: DIVERSION

Elevation (feet)	Storage (cubic-feet)	Elevation (feet)	Storage (cubic-feet)	Elevation (feet)	Storage (cubic-feet)
488.00	0	489.04	0	490.08	0
488.02	0	489.06	0	490.10	0
488.04	0	489.08	0	490.12	0
488.06	0	489.10	0	490.14	0
488.08	0	489.12	0	490.16	0
488.10	0	489.14	0	490.18	0
488.12	0	489.16	0	490.20	0
488.14	0	489.18	0	490.22	0
488.16	0	489.20	0	490.24	0
488.18	0	489.22	0	490.26	0
488.20	0	489.24	0	490.28	0
488.22	0	489.26	0	490.30	0
488.24	0	489.28	0	490.32	0
488.26	0	489.30	0	490.34	0
488.28	0	489.32	0	490.36	0
488.30	0	489.34	0	490.38	0
488.32	0	489.36	0	490.40	0
488.34	0	489.38	0	490.42	0
488.36	0	489.40	0	490.44	0
488.38	0	489.42	0		
488.40	0	489.44	0		
488.42	0	489.46	0		
488.44	0	489.48	0		
488.46	0	489.50	0		
488.48	0	489.52	0		
488.50	0	489.54	0		
488.52	0	489.56	0		
488.54	0	489.58	0		
488.56	0	489.60	0		
488.58	0	489.62	0		
488.60	0	489.64	0		
488.62	0	489.66	0		
488.64	0	489.68	0		
488.66	0	489.70	0		
488.68	0	489.72	0		
488.70	0	489.74	0		
488.72	0	489.76	0		
488.74	0	489.78	0		
488.76	0	489.80	0		
488.78	0	489.82	0		
488.80	0	489.84	0		
488.82	0	489.86	0		
488.84	0	489.88	0		
488.86	0	489.90	0		
488.88	0	489.92	0		
488.90	0	489.94	0		
488.92	0	489.96	0		
488.94	0	489.98	0		
488.96	0	490.00	0		
488.98	0	490.02	0		
489.00	0	490.04	0		
489.02	0	490.06	0		

250109 Dewpoint North R3

Prepared by Colliers Engineering & Design

HydroCAD® 10.20-5c s/n 04431 © 2023 HydroCAD Software Solutions LLC

Type III 24-hr 100-yr Rainfall=8.22"

Printed 1/23/2025

Page 77

Summary for Link PR: DP1 (PROPOSED)

Inflow Area = 224,299 sf, 36.66% Impervious, Inflow Depth > 6.04" for 100-yr event
Inflow = 21.58 cfs @ 12.21 hrs, Volume= 112,947 cf
Primary = 21.58 cfs @ 12.21 hrs, Volume= 112,947 cf, Atten= 0%, Lag= 0.0 min

Primary outflow = Inflow, Time Span= 0.00-30.00 hrs, dt= 0.05 hrs

Link PR: DP1 (PROPOSED)

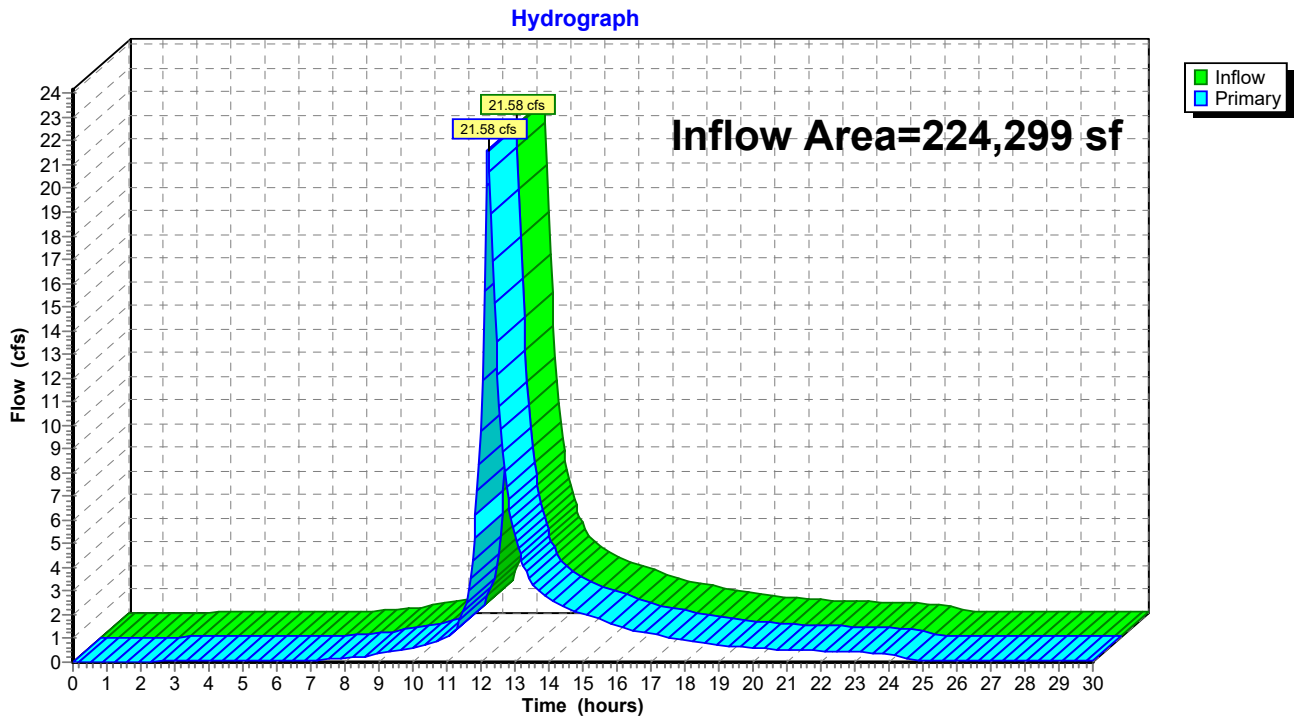

Appendix 3 | NYSDEC Green Infrastructure Worksheets

Is this project subject to Chapter 10 of the NYS Design Manual (i.e. WQv is equal to post-development 1 year runoff volume)?..... **No**

Design Point: 1
 P= 1.40 inch *Manually enter P, Total Area and Impervious Cover.*

Breakdown of Subcatchments

Catchment Number	Total Area (Acres)	Impervious Area (Acres)	Percent Impervious %	Rv	WQv (ft ³)	Description
1	0.59	0.40	68%	0.66	1,979	PW 1B1 (BIO-1B)
2	0.35	0.19	54%	0.54	958	PW 1C (BIO-1C)
3	1.36	1.14	84%	0.80	5,560	PW 1D & PW 1B2(BIO-1D)
4	0.21	0.12	57%	0.56	602	PW 1E (BIO-1E)
5	0.10	0.08	80%	0.77	391	PW 1F (BIO-1F)
6						
7						
8						
9						
10						
Subtotal (1-30)	2.61	1.93	74%	0.72	9,491	Subtotal 1
Total	2.61	1.93	74%	0.72	9,491	Initial WQv

0.22 af

Identify Runoff Reduction Techniques By Area

Technique	Total Contributing Area (Acre)	Contributing Impervious Area (Acre)	Notes
Conservation of Natural Areas	0.00	0.00	<i>minimum 10,000 sf</i>
Riparian Buffers	0.00	0.00	<i>maximum contributing length 75 feet to 150 feet</i>
Filter Strips	0.00	0.00	
Tree Planting	0.00	0.00	<i>Up to 100 sf directly connected impervious area may be subtracted per tree</i>
Total	0.00	0.00	

Recalculate WQv after application of Area Reduction Techniques

	Total Area (Acres)	Impervious Area (Acres)	Percent Impervious %	Runoff Coefficient Rv	WQv (ft ³)
"<<Initial WQv"	2.61	1.93	74%	0.72	9,491
Subtract Area	0.00	0.00			
WQv adjusted after Area Reductions	2.61	1.93	74%	0.72	9,491
Disconnection of Rooftops		0.00			
Adjusted WQv after Area Reduction and Rooftop Disconnect	2.61	1.93	74%	0.72	9,491
WQv reduced by Area Reduction techniques					0

0.22 af
0.00 af

(For use on HSG C or D Soils with underdrains)

$$Af = WQv * (df) / [k * (hf + df)(tf)]$$

- | | | | |
|------------|---|----------|--|
| <i>Af</i> | Required Surface Area (ft ²) | | The hydraulic conductivity [ft/day], can be varied depending on the properties of the soil media. Some reported conductivity values are: Sand - 3.5 ft/day (City of Austin 1988); Peat - 2.0 ft/day (Galli 1990); Leaf Compost - 8.7 ft/day (Claytor and Schueler, 1996); Bioretention Soil (0.5 ft/day (Claytor & |
| <i>WQv</i> | Water Quality Volume (ft ³) | | |
| <i>df</i> | Depth of the Soil Medium (feet) | <i>k</i> | |
| <i>hf</i> | Average height of water above the planter bed | | |
| <i>tf</i> | Volume Through the Filter Media (days) | | |

Design Point:	1						
Enter Site Data For Drainage Area to be Treated by Practice							
Catchment Number	Total Area (Acres)	Impervious Area (Acres)	Percent Impervious %	Rv	WQv (ft ³)	Precipitation (in)	Description
1	0.59	0.40	0.68	0.66	1979.44	1.40	PW 1B1 (BIO-1B)
Enter Impervious Area Reduced by Disconnection of Rooftops		0.00	68%	0.66	1,979	<<WQv after adjusting for Disconnected Rooftops	
Enter the portion of the WQv that is not reduced for all practices routed to this practice.					0	ft ³	
Soil Information							
Soil Group	D						
Soil Infiltration Rate	0.00	in/hour	Okay				
Using Underdrains?	Yes Okay						
Calculate the Minimum Filter Area							
				Value	Units	Notes	
WQv				1,979	ft ³		
Enter Depth of Soil Media		<i>df</i>		2.5	ft	2.5-4 ft	
Enter Hydraulic Conductivity		<i>k</i>		0.5	ft/day		
Enter Average Height of Ponding		<i>hf</i>		0.5	ft	6 inches max.	
Enter Filter Time		<i>tf</i>		2	days		
Required Filter Area		Af		1650	ft²		
Determine Actual Bio-Retention Area							
Filter Width	1	ft					
Filter Length	2038	ft					
Filter Area	2038	ft ²					
Actual Volume Provided	2446	ft ³					
Determine Runoff Reduction							
Is the Bioretention contributing flow to another practice?	No	Select Practice					
RRv	978						
RRv applied	978	ft³	This is 40% of the storage provided or WQv whichever is less.				
Volume Treated	1,001	ft ³	This is the portion of the WQv that is not reduced in the practice.				
Volume Directed	0	ft ³	This volume is directed another practice				
Sizing V	OK	Check to be sure Area provided ≥ Af					

(For use on HSG C or D Soils with underdrains)

$Af = WQv * (df) / [k * (hf + df)(tf)]$

- | | | | |
|------------|---|----------|--|
| <i>Af</i> | Required Surface Area (ft ²) | | The hydraulic conductivity [ft/day], can be varied depending on the properties of the soil media. Some reported conductivity values are: Sand - 3.5 ft/day (City of Austin 1988); Peat - 2.0 ft/day (Galli 1990); Leaf Compost - 8.7 ft/day (Claytor and Schueler, 1996); Bioretention Soil (0.5 ft/day (Claytor & Schueler, 1996) |
| <i>WQv</i> | Water Quality Volume (ft ³) | | |
| <i>df</i> | Depth of the Soil Medium (feet) | <i>k</i> | |
| <i>hf</i> | Average height of water above the planter bed | | |
| <i>tf</i> | Volume Through the Filter Media (days) | | |

Design Point:	1						
Enter Site Data For Drainage Area to be Treated by Practice							
Catchment Number	Total Area (Acres)	Impervious Area (Acres)	Percent Impervious %	Rv	WQv (ft ³)	Precipitation (in)	Description
2	0.35	0.19	0.54	0.54	957.96	1.40	PW 1C (BIO-1C)
Enter Impervious Area Reduced by Disconnection of Rooftops		0.00	54%	0.54	958	<<WQv after adjusting for Disconnected Rooftops	
Enter the portion of the WQv that is not reduced for all practices routed to this practice.					0	ft ³	
Soil Information							
Soil Group	D						
Soil Infiltration Rate	0.00	in/hour	Okay				
Using Underdrains?	Yes Okay						
Calculate the Minimum Filter Area							
				Value	Units	Notes	
WQv				958	ft ³		
Enter Depth of Soil Media		<i>df</i>		2.5	ft	2.5-4 ft	
Enter Hydraulic Conductivity		<i>k</i>		0.5	ft/day		
Enter Average Height of Ponding		<i>hf</i>		0.15	ft	6 inches max.	
Enter Filter Time		<i>tf</i>		2	days		
Required Filter Area		<i>Af</i>		904	ft²		
Determine Actual Bio-Retention Area							
Filter Width	1	ft					
Filter Length	1379	ft					
Filter Area	1379	ft ²					
Actual Volume Provided	1462	ft ³					
Determine Runoff Reduction							
Is the Bioretention contributing flow to another practice?	Yes	Select Practice	Bioretention				
RRv	585						
RRv applied	585	ft³	This is 40% of the storage provided or WQv whichever is less.				
Volume Treated	0	ft ³	This is the portion of the WQv that is not reduced in the practice.				
Volume Directed	373	ft ³	This volume is directed another practice				
Sizing V	OK	Check to be sure Area provided ≥ Af					

(For use on HSG C or D Soils with underdrains)

$$Af = WQv * (df) / [k * (hf + df)(tf)]$$

- | | | | |
|------------|---|----------|--|
| <i>Af</i> | Required Surface Area (ft ²) | | The hydraulic conductivity [ft/day], can be varied depending on the properties of the soil media. Some reported conductivity values are: Sand - 3.5 ft/day (City of Austin 1988); Peat - 2.0 ft/day (Galli 1990); Leaf Compost - 8.7 ft/day (Claytor and Schueler, 1996); Bioretention Soil (0.5 ft/day (Claytor & |
| <i>WQv</i> | Water Quality Volume (ft ³) | | |
| <i>df</i> | Depth of the Soil Medium (feet) | <i>k</i> | |
| <i>hf</i> | Average height of water above the planter bed | | |
| <i>tf</i> | Volume Through the Filter Media (days) | | |

Design Point:	1						
Enter Site Data For Drainage Area to be Treated by Practice							
Catchment Number	Total Area (Acres)	Impervious Area (Acres)	Percent Impervious %	Rv	WQv (ft ³)	Precipitation (in)	Description
3	1.36	1.14	0.84	0.80	5559.71	1.40	PW 1D & PW 1B2(BIO-1D)
Enter Impervious Area Reduced by Disconnection of Rooftops		0.00	84%	0.80	5,560	<<WQv after adjusting for Disconnected Rooftops	
Enter the portion of the WQv that is not reduced for all practices routed to this practice.					0	ft ³	
Soil Information							
Soil Group	D						
Soil Infiltration Rate	0.00	in/hour	Okay				
Using Underdrains?	Yes Okay						
Calculate the Minimum Filter Area							
				Value	Units	Notes	
WQv				5,560	ft ³		
Enter Depth of Soil Media		<i>df</i>		2.5	ft	2.5-4 ft	
Enter Hydraulic Conductivity		<i>k</i>		0.5	ft/day		
Enter Average Height of Ponding		<i>hf</i>		0.5	ft	6 inches max.	
Enter Filter Time		<i>tf</i>		2	days		
Required Filter Area		Af		4633	ft²		
Determine Actual Bio-Retention Area							
Filter Width	1	ft					
Filter Length	6887	ft					
Filter Area	6887	ft ²					
Actual Volume Provided	8264	ft ³					
Determine Runoff Reduction							
Is the Bioretention contributing flow to another practice?	No	Select Practice					
RRv	3,306						
RRv applied	3,306	ft³	This is 40% of the storage provided or WQv whichever is less.				
Volume Treated	2,254	ft ³	This is the portion of the WQv that is not reduced in the practice.				
Volume Directed	0	ft ³	This volume is directed another practice				
Sizing V	OK	Check to be sure Area provided ≥ Af					

(For use on HSG C or D Soils with underdrains)

$Af = WQv * (df) / [k * (hf + df)(tf)]$

- | | | | |
|------------|---|----------|--|
| <i>Af</i> | Required Surface Area (ft ²) | | The hydraulic conductivity [ft/day], can be varied depending on the properties of the soil media. Some reported conductivity values are: Sand - 3.5 ft/day (City of Austin 1988); Peat - 2.0 ft/day (Galli 1990); Leaf Compost - 8.7 ft/day (Claytor and Schueler, 1996); Bioretention Soil (0.5 ft/day (Claytor & |
| <i>WQv</i> | Water Quality Volume (ft ³) | | |
| <i>df</i> | Depth of the Soil Medium (feet) | <i>k</i> | |
| <i>hf</i> | Average height of water above the planter bed | | |
| <i>tf</i> | Volume Through the Filter Media (days) | | |

Design Point:	1						
Enter Site Data For Drainage Area to be Treated by Practice							
Catchment Number	Total Area (Acres)	Impervious Area (Acres)	Percent Impervious %	Rv	WQv (ft ³)	Precipitation (in)	Description
4	0.21	0.12	0.57	0.56	602.22	1.40	PW 1E (BIO-1E)
Enter Impervious Area Reduced by Disconnection of Rooftops		0.00	57%	0.56	602	<<WQv after adjusting for Disconnected Rooftops	
Enter the portion of the WQv that is not reduced for all practices routed to this practice.					0	ft ³	
Soil Information							
Soil Group	D						
Soil Infiltration Rate	0.00	in/hour	Okay				
Using Underdrains?	Yes Okay						
Calculate the Minimum Filter Area							
				Value	Units	Notes	
WQv				602	ft ³		
Enter Depth of Soil Media		<i>df</i>		2.5	ft	2.5-4 ft	
Enter Hydraulic Conductivity		<i>k</i>		0.5	ft/day		
Enter Average Height of Ponding		<i>hf</i>		0.5	ft	6 inches max.	
Enter Filter Time		<i>tf</i>		2	days		
Required Filter Area		<i>Af</i>		502	ft²		
Determine Actual Bio-Retention Area							
Filter Width	1	ft					
Filter Length	715	ft					
Filter Area	715	ft ²					
Actual Volume Provided	858	ft ³					
Determine Runoff Reduction							
Is the Bioretention contributing flow to another practice?	No	Select Practice					
RRv	343						
RRv applied	343	ft³	This is 40% of the storage provided or WQv whichever is less.				
Volume Treated	259	ft ³	This is the portion of the WQv that is not reduced in the practice.				
Volume Directed	0	ft ³	This volume is directed another practice				
Sizing V	OK	Check to be sure Area provided ≥ Af					

(For use on HSG C or D Soils with underdrains)

$Af = WQv * (df) / [k * (hf + df)(tf)]$

- | | | | |
|------------|---|----------|--|
| <i>Af</i> | Required Surface Area (ft ²) | | The hydraulic conductivity [ft/day], can be varied depending on the properties of the soil media. Some reported conductivity values are: Sand - 3.5 ft/day (City of Austin 1988); Peat - 2.0 ft/day (Galli 1990); Leaf Compost - 8.7 ft/day (Claytor and Schueler, 1996); Bioretention Soil (0.5 ft/day (Claytor & |
| <i>WQv</i> | Water Quality Volume (ft ³) | | |
| <i>df</i> | Depth of the Soil Medium (feet) | <i>k</i> | |
| <i>hf</i> | Average height of water above the planter bed | | |
| <i>tf</i> | Volume Through the Filter Media (days) | | |

Design Point:	1						
Enter Site Data For Drainage Area to be Treated by Practice							
Catchment Number	Total Area (Acres)	Impervious Area (Acres)	Percent Impervious %	Rv	WQv (ft ³)	Precipitation (in)	Description
5	0.10	0.08	0.80	0.77	391.31	1.40	PW 1F (BIO-1F)
Enter Impervious Area Reduced by Disconnection of Rooftops		0.00	80%	0.77	391	<<WQv after adjusting for Disconnected Rooftops	
Enter the portion of the WQv that is not reduced for all practices routed to this practice.					0	ft ³	
Soil Information							
Soil Group	D						
Soil Infiltration Rate	0.00	in/hour	Okay				
Using Underdrains?	Yes Okay						
Calculate the Minimum Filter Area							
				Value	Units	Notes	
WQv				391	ft ³		
Enter Depth of Soil Media		<i>df</i>		2.5	ft	2.5-4 ft	
Enter Hydraulic Conductivity		<i>k</i>		0.5	ft/day		
Enter Average Height of Ponding		<i>hf</i>		0.25	ft	6 inches max.	
Enter Filter Time		<i>tf</i>		2	days		
Required Filter Area		<i>Af</i>		356	ft²		
Determine Actual Bio-Retention Area							
Filter Width	1	ft					
Filter Length	454	ft					
Filter Area	454	ft ²					
Actual Volume Provided	499	ft ³					
Determine Runoff Reduction							
Is the Bioretention contributing flow to another practice?	No	Select Practice					
RRv	200						
RRv applied	200	ft³	This is 40% of the storage provided or WQv whichever is less.				
Volume Treated	192	ft ³	This is the portion of the WQv that is not reduced in the practice.				
Volume Directed	0	ft ³	This volume is directed another practice				
Sizing V	OK	Check to be sure Area provided ≥ Af					

Appendix 4 | SPDES GP-0-20-001



**Department of
Environmental
Conservation**

*** DRAFT ***

NEW YORK STATE
DEPARTMENT OF ENVIRONMENTAL
CONSERVATION (NYSDEC)

SPDES CONSTRUCTION GENERAL PERMIT (CGP)
FOR STORMWATER DISCHARGES

From

CONSTRUCTION ACTIVITY

Permit No. GP-0-25-001

Issued Pursuant to Article 17, Titles 7, 8 and Article 70
of the Environmental Conservation Law

Anticipated
Effective Date: January 29, 2025

Anticipated
Expiration Date: January 28, 2030

Scott E. Sheeley
Chief Permit Administrator

Authorized Signature

Date

Address: NYSDEC
Division of Environmental Permits
625 Broadway, 4th Floor
Albany, N.Y. 12233-1750

PREFACE

Pursuant to Section 402 of the Clean Water Act (CWA), and 40 CFR 122.26(b)(14)(x), (15)(i), and (15)(ii), *stormwater discharges* from certain *construction activities* are unlawful unless they are authorized by a National Pollutant Discharge Elimination System (NPDES) permit or by a state permit program. New York State administers the approved State Pollutant Discharge Elimination System (SPDES) program with permits issued in accordance with the New York State Environmental Conservation Law (ECL) Article 17, Titles 7 and 8, and Article 70, as well as 6 NYCRR Parts 621 and 750.

Construction activities constitute construction of a *point source* and, therefore, pursuant to ECL sections 17-0505, 17-0701, and 17-0803, the *owner or operator* must have coverage under a SPDES permit prior to *commencement of construction activities*. The *owner or operator* cannot wait until there is an actual *discharge* from the *construction site* to obtain permit coverage.

***Note: The italicized words/phrases within this permit are defined in Appendix A.**

**NEW YORK STATE DEPARTMENT OF ENVIRONMENTAL CONSERVATION
SPDES CONSTRUCTION GENERAL PERMIT (CGP) GP-0-25-001
FOR STORMWATER DISCHARGES FROM CONSTRUCTION ACTIVITIES**

Table of Contents

Part I. How to Obtain Coverage and General Requirements	5
A. Eligibility Requirements	5
B. Types of <i>Discharges</i> Authorized	8
C. Prohibited <i>Discharges</i>	9
D. Electronic Notice of Intent (eNOI) Submittal.....	10
E. General Requirements for <i>Owners or Operators</i> with Permit Coverage	13
F. Permit Coverage for <i>Discharges</i> Authorized Under GP-0-20-001.....	17
G. Change of <i>Owner or Operator</i>	18
Part II. Water Quality-Based Effluent Limitations	19
A. Maintaining Water Quality	19
B. Effluent Limitations Applicable to <i>Discharges</i> from <i>Construction Activities</i>	20
C. Post-Construction Stormwater Management Practice (SMP) Requirements ...	22
Part III. Stormwater Pollution Prevention Plan (SWPPP)	28
A. General <i>SWPPP</i> Requirements	28
B. Required <i>SWPPP</i> Contents	31
C. Required <i>SWPPP</i> Components by Project Type.....	36
Part IV. Inspection and Maintenance Requirements	36
A. General Construction Site Inspection and Maintenance Requirements	36
B. Contractor Maintenance Inspection Requirements	36
C. <i>Qualified Inspector</i> Inspection Requirements.....	37
Part V. How to Terminate CGP Coverage.....	41
A. Electronic Notice of Termination (eNOT) Submittal.....	41
Part VI. Record Retention and Reporting.....	43
A. Record Retention	43
B. Reporting	44
Part VII. Standard Permit Requirements	44
A. Duty to Comply.....	44
B. Need to Halt or Reduce Activity Not a Defense.....	44
C. Penalties	44
D. False Statements	44
E. Re-Opener Clause	45
F. Duty to Mitigate	45
G. Requiring Another General Permit or Individual SPDES Permit.....	45
H. Duty to Provide Information.....	47
I. Extension	47
J. Signatories and Certification	47
K. Inspection and Entry	50
L. Confidentiality of Information.....	50
M. Other Permits May Be Required	51

N.	NYSDEC Orders or Civil Decrees/Judgments.....	51
O.	Property Rights	51
P.	Compliance with Interstate Standards.....	51
Q.	Oil and Hazardous Substance Liability.....	51
R.	Severability.....	52
S.	NYSDEC Approved Forms.....	52
APPENDIX A – Abbreviations and Definitions.....		53
	Abbreviations.....	53
	Definitions.....	54
APPENDIX B – Required SWPPP Components by Project Type.....		62
	Table 1.....	62
	Table 2.....	64
APPENDIX C – Watersheds Requiring Enhanced Phosphorus Removal.....		66
APPENDIX D – Impaired Waterbodies (by Construction Related Pollutants)		72
APPENDIX E – List of NYSDEC Regional Offices.....		78
APPENDIX F – SWPPP Preparer Certification Form		79
APPENDIX G – MS4 SWPPP Acceptance Form.....		81
APPENDIX H – NYCDEP SWPPP Acceptance/Approval Form		84
APPENDIX I – MS4 No Jurisdiction Form.....		87
APPENDIX J – Owner/Operator Certification Form.....		89

Part I. How to Obtain Coverage and General Requirements

To be covered under this permit, the *owner or operator* must meet all eligibility requirements in Part I.A. and follow the requirements for obtaining permit coverage in Part I.D., F., or G.

A. Eligibility Requirements

1. The *owner's or operator's construction activities* involve soil disturbances of:
 - a. one or more acres; or
 - b. less than one acre which are part of a *common plan of development or sale* that will ultimately disturb one or more acres; or
 - c. less than one acre where NYSDEC has determined that a SPDES permit is required for *stormwater discharges* based on the potential for contribution to a violation of a *water quality standard* or for significant contribution of pollutants to *surface waters of the State*.
 - i. 5,000 square feet or more, but less than one acre, and are in the New York City Watershed located east of the Hudson River, Appendix C Figure 1; or
 - ii. 20,000 square feet or more, but less than one acre, within the municipal boundaries of the City of New York (NYC); or
 - iii. less than 20,000 square feet which are part of a *common plan of development or sale* that will ultimately disturb 20,000 square feet or more, but less than one acre, within the municipal boundaries of NYC; or
 - iv. that creates 5,000 square feet or more of *impervious area* within the municipal boundaries of NYC.
2. *Discharges* from the *owner's or operator's construction activities* are/were not:
 - a. already covered by a different SPDES permit; or
 - b. covered under a different SPDES permit that was denied, terminated, or revoked; or

- c. identified in an expired individual SPDES permit that was not renewed;
or
 - d. required to obtain an individual SPDES permit or another general SPDES permit in accordance with Part VII.K.
3. If *construction activities* may adversely affect a species that is endangered, threatened, or of special concern, the *owner or operator* must obtain a:
- a. permit issued pursuant to 6 NYCRR Part 182 for the project; or
 - b. letter issued by NYSDEC of non-jurisdiction pursuant to 6 NYCRR Part 182 for the project.
4. If *construction activities* have the potential to affect an *historic property*, the *owner or operator* must obtain:
- a. documentation that the *construction activity* is not within an archeologically sensitive area indicated on the sensitivity map, and that the *construction activity* is not located on or immediately adjacent to a property listed or determined to be eligible for listing on the National or State Registers of Historic Places, and that there is no new permanent building on the *construction site* within the following distances from a building, structure, or object that is more than 50 years old, or if there is such a new permanent building on the *construction site* within those parameters that NYS Office of Parks, Recreation and Historic Preservation (OPRHP), a Historic Preservation Commission of a Certified Local Government, or a qualified preservation professional has determined that the building, structure, or object more than 50 years old is not historically/archeologically significant:
 - i. 1-5 acres of disturbance - 20 feet; or
 - ii. 5-20 acres of disturbance - 50 feet; or
 - iii. 20+ acres of disturbance - 100 feet; or

- b. NYSDEC consultation form sent to OPRHP,¹ and copied to NYSDEC's Agency Historic Preservation Officer (APO), and
 - i. the State Environmental Quality Review Act (SEQR) Environmental Assessment Form (EAF) with a negative declaration or the Findings Statement, with documentation of OPRHP's agreement with the resolution; or
 - ii. documentation from OPRHP that the *construction activity* will result in No Impact; or
 - iii. documentation from OPRHP providing a determination of No Adverse Impact; or
 - iv. a Letter of Resolution signed by the *owner or operator*, OPRHP and the DEC APO which allows for this *construction activity* to be eligible for coverage under the general permit in terms of the State Historic Preservation Act (SHPA); or
 - c. documentation of satisfactory compliance with Section 106 of the National Historic Preservation Act for a coterminous project area:
 - i. No Affect; or
 - ii. No Adverse Affect; or
 - iii. Executed Memorandum of Agreement; or
 - d. documentation that SHPA Section 14.09 has been completed by NYSDEC or another state agency.
5. If *construction activities* are subject to SEQR, the *owner or operator* must obtain documentation that SEQR has been satisfied.
6. If *construction activities* are not subject to SEQR, but subject to the equivalent environmental review from another New York State or federal agency, the *owner or operator* must obtain documentation that project review, pursuant to

¹ The consultation form can be submitted, along with other project information, through OPRHP's Cultural Resource Information System (CRIS) portal. If submitted through CRIS, paper copies of the consultation form need not be mailed.

a process equivalent to SEQR from another New York State or federal agency, has been satisfied.

7. If *construction activities* require Uniform Procedures Act (UPA) Permits (see 6 NYCRR Part 621) from NYSDEC, or the equivalent from another New York State or federal agency, the *owner or operator* must:
 - a. obtain all such necessary permits; or
 - b. receive notification from NYSDEC pursuant to 6 NYCRR 621.3(a)(4) excepting Part I.A.7.a.
8. *Construction activities* are not eligible if they meet the following criteria in Part I.A.8.a. or b.:
 - a. For linear transportation and linear utility project types, the *construction activities*:
 - i. are within the watershed of *surface waters of the State* classified as AA or AA-s identified utilizing the Stormwater Interactive Map on NYSDEC's website;
 - ii. are undertaken on land with no existing *impervious cover*; and
 - iii. disturb two or more acres of *steep slope*; or
 - b. For all other project types, the *construction activities*:
 - i. are within the watershed of *surface waters of the State* classified as AA or AA-s identified utilizing the Stormwater Interactive Map on NYSDEC's website;
 - ii. are undertaken on land with no existing *impervious cover*; and
 - iii. disturb one or more acres of *steep slope*.

B. Types of *Discharges* Authorized

1. *Stormwater discharges*, including *stormwater* runoff, snowmelt runoff, and surface runoff and drainage, associated with *construction activity*, are

authorized under this permit provided that appropriate *stormwater* controls are designed, installed, and maintained in accordance with Part III.

2. The following non-*stormwater discharges* associated with *construction activity* are authorized under this permit:
 - a. Non-*stormwater discharges* listed in 6 NYCRR 750-1.2(a)(29)(vi), with the following exception: “*Discharges* from firefighting activities are authorized only when the firefighting activities are emergencies/unplanned”;
 - b. Non-*stormwater discharges* of waters to which other components have not been added that are used in accordance with the *SWPPP* to control dust or irrigate vegetation in stabilized areas; and
 - c. Uncontaminated *discharges* from *dewatering* operations.
3. Authorized *discharges* of *stormwater* or authorized *discharges* of non-*stormwater*, commingled with a *discharge* authorized by a different SPDES permit and/or a *discharge* that does not require SPDES permit authorization, are also authorized under this permit.

C. Prohibited *Discharges*

1. Non-*stormwater discharges* prohibited under this permit include but are not limited to:
 - a. Wastewater from washout of concrete;
 - b. Wastewater from washout and cleanout of stucco, paint, form release oils, curing compounds, and other construction materials;
 - c. Fuels, oils, or other *pollutants* used in vehicle and equipment operation and maintenance;
 - d. Soaps, solvents, or detergents used in vehicle and equipment washing or external building washdown; and
 - e. Toxic or hazardous substances from a spill or other release.

D. Electronic Notice of Intent (eNOI) Submittal

To receive authorization in accordance with Part I.D.3.b., the *owner or operator* must submit a complete eNOI in accordance with the requirements in Part I.D. The eNOI contains questions to: ensure eligibility requirements in Part I.A. have been met; obtain *owner or operator* contact information; obtain the total area to be disturbed and the existing/future *impervious areas* (rounded to the nearest tenth of an acre); confirm *Traditional Land Use Control MS4 Operator* jurisdiction over construction projects; satisfy the EPA eRule requirements; confirm that the Water Quality-Based Effluent Limitations in Part II. have been met; demonstrate consideration of the future risks due to climate change in accordance with Part III.A.2.; and confirm that the other *Stormwater Pollution Prevention Plan (SWPPP)* requirements in Part III. have been met.

1. An eNOI may be submitted for:

- a. *construction activities* that are not part of a *common plan of development or sale*; or
- b. an entire *common plan of development or sale*; or
- c. separate *phase(s)* of a *common plan of development or sale* if the following requirements are met:
 - i. the *common plan of development or sale* meets the eligibility requirements of Part I.A.5. or 6.;
 - ii. the *phase(s)* meet(s) all other eligibility requirements of Part I.A.; and
 - iii. Part III.C. Required *SWPPP* Components by Project Type is based on the *common plan of development or sale*, not the *phase(s)*; or
- d. *tree clearing* if the following requirements are met:
 - i. the *tree clearing* is associated with, or will support, a *renewable energy* generation, transmission, or storage project that meets Part I.A.5. and 6.
 - ii. the *tree clearing*:
 1. meets all other eligibility requirements of Part I.A.;

2. will occur in NYSDEC's Regions 3-9;
 3. is not within ¼ mile of a bat hibernaculum protected pursuant to 6 NYCRR Part 182; and
 4. will occur between November 1st and March 31st.
2. As prerequisites for submitting an eNOI, the *owner or operator* must:
- a. prepare a *SWPPP* for Part I.D.1.a., b., c., or d. in accordance with Part III.;
 - b. based on the following criteria, upload the following signature forms signed in accordance with Part VII.J. to the eNOI prior to submission:
 - i. for all eNOIs:
 1. the *SWPPP* Preparer Certification Form, Appendix F, signed by the *SWPPP* preparer;
 2. the Owner/Operator Certification Form, Appendix J, signed by the *owner or operator*; and
 - ii. if an eNOI includes *construction activities* within the municipal boundary(ies) of *Traditional Land Use Control MS4 Operator(s)* that will *discharge* to the *MS4(s)*:
 1. determine if the *Traditional Land Use Control MS4 Operator(s)* have review authority. A *Traditional Land Use Control MS4 Operator* does not have review authority where:
 - a. the *owner or operator* is the *Traditional Land Use Control MS4 Operator*; or
 - b. there is a statute exempting the *owner or operator* from zoning review by the *Traditional Land Use Control MS4 Operator*; or
 - c. there is no such statute per Part I.D.2.b.ii.1.c., the *Traditional Land Use Control MS4 Operator* concludes, after public hearing, that it does not

have zoning review authority in accordance with Legal Memorandum LU14 Updated January 2020 “Governmental Immunity from Zoning and Other Legislation”; and

2. if the *Traditional Land Use Control MS4 Operator(s)* have review authority, submit the *SWPPP* to the *Traditional Land Use Control MS4 Operator(s)* for review and have:
 - a. if outside the municipal boundaries of NYC: the MS4 SWPPP Acceptance Form, Appendix G, signed by the principal executive officer or ranking elected official from the *Traditional Land Use Control MS4 Operator*, or by a duly authorized representative of that person in accordance with Part VII.J.2.; or
 - b. if within the municipal boundaries of NYC: The City of New York Department of Environmental Protection (NYCDEP) SWPPP Acceptance/Approval Form, Appendix H, signed by the principal executive officer or ranking elected official from the *Traditional Land Use Control MS4 Operator*, or by a duly authorized representative of that person in accordance with Part VII.J.2.; and
3. if the *Traditional Land Use Control MS4 Operator* does not have review authority, have the MS4 No Jurisdiction Form, Appendix I, signed by the principal executive officer or ranking elected official from the *Traditional Land Use Control MS4 Operator*, or by a duly authorized representative of that person in accordance with Part VII.J.2.

3. Submitting an eNOI:

- a. The *owner or operator* must submit a complete Notice of Intent

electronically using a NYSDEC approved form.²

- b. The *owner or operator* is authorized to *commence construction activity* as of the authorization date indicated in the Letter of Authorization (LOA), which is sent by NYSDEC after a complete eNOI is submitted.
 - i. If an eNOI is received for a *SWPPP* demonstrating *equivalence* in accordance with Part III.B.1. or 2., if the *SWPPP* includes *construction activities* that are not within the municipal boundary(ies) of *Traditional Land Use Control MS4 Operator(s)*, and/or if the *SWPPP* includes *construction activities* within the municipal boundary(ies) of *Traditional Land Use Control MS4 Operator(s)* that do not have review authority in accordance with Part I.D.2.b.ii.1., the authorization date indicated in the LOA will be 60 business days after the eNOI submission date.

4. Coverage under this permit authorizes *stormwater discharges* from only those areas of disturbance that are identified in the eNOI. Prior to disturbing soil not yet authorized, the *owner or operator* must:

- a. amend the *SWPPP* and eNOI in accordance with Part I.D.2. (contact Stormwater_info@dec.ny.gov to receive access to amend the eNOI); and
- b. receive an updated LOA per Part I.D.3.b.

5. If the *owner or operator* makes substantive revisions to the *SWPPP* (e.g. the scope of the project changes significantly, the type of SMP(s) changes, there is a reduction in the sizing of the SMP(s) that were not reflected in the original eNOI submitted to NYSDEC, they must amend the eNOI in accordance with Part I.D.2. prior to implementing such revisions (contact Stormwater_info@dec.ny.gov to receive access to amend the eNOI).

E. General Requirements for Owners or Operators with Permit Coverage

1. As of the date the LOA is received, the *owner or operator* must make the eNOI and *SWPPP* available for review and copying in accordance with the requirements in Part VII.H.

² Unless NYSDEC grants a waiver in accordance with 40 CFR 127.15(c) or (d). All waiver requests must be submitted to Stormwater_info@dec.ny.gov or NYSDEC, Bureau of Water Permits, 625 Broadway, 4th Floor, Albany, New York 12233-3505.

2. The *owner or operator* must ensure compliance with all requirements of this permit and that the provisions of the *SWPPP*, including any changes made to the *SWPPP* in accordance with Part III.A.5., are properly implemented and maintained from the *commencement of construction activity* until:
 - a. all areas of disturbance have achieved *final stabilization*; and
 - b. the electronic Notice of Termination (eNOT) has been accepted by NYSDEC in accordance with Part V.A.5.
3. The *owner or operator* must maintain at the *construction site*, until Part I.E.2.a. and b. have been met, as of the date the LOA is received, a copy of:
 - a. all documentation necessary to demonstrate eligibility with this permit;
 - b. this permit;
 - c. the *SWPPP*;
 - d. the signed *SWPPP* Preparer Certification Form;
 - e. the signed MS4 *SWPPP* Acceptance Form or signed NYCDEP *SWPPP* Acceptance/Approval Form or signed MS4 No Jurisdiction Form (when applicable);
 - f. the signed Owner/Operator Certification Form;
 - g. the eNOI; and
 - h. the LOA.
4. The *owner or operator* must maintain at the *construction site*, until Part I.E.2.a. and b. have been met, as of the date the documents become final or are received, a copy of the:
 - a. responsible contractor's or subcontractor's certification statement(s) in accordance with Part III.A.7.;
 - b. inspection reports in accordance with Part IV.C.4. and 6.;

- c. Request to Disturb Greater Than Five Acres and the Authorization Letter to Disturb Greater Than Five Acres in accordance with Part I.E.6. (when applicable); and
 - d. Request to Continue Coverage and the Letter of Continued Coverage (LOCC) in accordance with Part I.F.2. and 4. (when applicable).
5. The *owner or operator* must maintain the documents in Part I.E.3. and 4. in a secure location, such as a job trailer, on-site construction office, or mailbox with lock. The secure location must be accessible during normal business hours to an individual performing a compliance inspection. The documents must be paper documents unless electronic documents are accessible to the inspector during an inspection to the same extent as a paper copy stored at the site would be. If electronic documents are kept on site, the *owner or operator* must maintain functional equipment on site available to an inspector during normal hours of operation such that an inspector may view the electronic documents in a format that can be read in a similar manner as a paper record and in a legally dependable format with no less evidentiary value than their paper equivalent.
6. The *owner or operator* must meet the following requirements prior to disturbing greater than five acres of soil at any one time:
- a. The *owner or operator* must submit a written Request to Disturb Greater Than Five Acres to:
 - i. NYSDEC's Regional Office Division of Water staff based on the project location, Appendix E, if a *Traditional Land Use Control MS4 Operator* does not have review authority in accordance with Part I.D.2.b.ii.1.; or
 - ii. the *Traditional Land Use Control MS4 Operator*, if a *Traditional Land Use Control MS4 Operator* has review authority in accordance with Part I.D.2.b.ii.1.; or
 - iii. NYSDEC's Regional Office Division of Water staff based on the project location, Appendix E, and each involved *Traditional Land Use Control MS4 Operator*, if the project spans multiple municipalities with more than one *Traditional Land Use Control MS4 Operator* involved with review authority in accordance with Part I.D.2.b.ii.1.
 - b. The written Request to Disturb Greater Than Five Acres must include:

- i. The SPDES permit identification number (Permit ID);
 - ii. Full technical justification demonstrating why alternative methods of construction that would result in five acres of soil disturbance or less at any one time are not feasible;
 - iii. The phasing plan for the project and sequencing plans for all *phases* from the *SWPPP* in accordance with Part III.B.1.d.;
 - iv. Plans with locations and details of standard and heightened erosion and sediment control practices;
 - v. Acknowledgment that “the *owner or operator* will comply with the requirements in Part IV.C.2.b.”; and
 - vi. Acknowledgment that “the *owner or operator* will comply with the requirements in Part II.B.1.b.”
- c. The *owner or operator* must be in receipt of an Authorization Letter to Disturb Greater Than Five Acres, which will include a time limit indicating when the authorization ceases and indicate a maximum area (acres) of soil disturbance allowed at any one time, from:
- i. NYSDEC, if Part I.E.5.a.i. or iii. apply; or
 - ii. the *Traditional Land Use Control MS4 Operator*, if Part I.E.5.a.ii. applies.
7. Upon a finding of significant non-compliance with the practices described in the *SWPPP* or violation of this permit, NYSDEC may order an immediate stop to all *construction activity* at the site until the non-compliance is remedied. The stop work order must be in writing, describe the non-compliance in detail, and be sent to the *owner or operator*.
8. If any human remains or archaeological remains are encountered during excavation, the *owner or operator* must immediately cease, or cause to cease, all *construction activity* in the area of the remains and notify the appropriate Regional Water Engineer (RWE).³ *Construction activity* shall not resume until written permission to do so has been received from the RWE.

³ The Regional Water Manager where a DEC Region does not have a RWE.

9. Where there are planned amendments or modifications to the post-construction *stormwater* management practice (SMP) component of the *SWPPP* required by Part III.A.5. and 6., the *owner or operator* must:
 - a. notify NYSDEC via email at Stormwater_info@dec.ny.gov;
 - b. prior to implementing the planned amendments or modifications to the SMPs, update the eNOI to reflect the planned amendments or modifications and resubmit the eNOI in accordance with Part I.D.; and
 - c. implement the planned amendments or modifications to the SMPs after the eNOI updates submitted in accordance with Part I.E.8.b. have been accepted by NYSDEC.
10. The eNOI, *SWPPP*, and inspection reports required by this permit are public documents that the *owner or operator* must make available for review and copying by any person within five business days of the *owner or operator* receiving a written request by any such person to review these documents. Copying of documents will be done at the requester's expense.

F. Permit Coverage for *Discharges* Authorized Under GP-0-20-001

When applicable:

1. Upon the effective date of this permit, an *owner or operator of a construction activity*, with coverage under GP-0-20-001, will have interim coverage under GP-0-25-001 for 45 calendar days starting on the effective date of GP-0-25-001 so long as the *owner or operator* maintains compliance with all applicable requirements of this permit.
2. Within 30 calendar days of the effective date of this permit, the *owner or operator*, with coverage under GP-0-20-001, must submit a complete Request to Continue Coverage electronically using a NYSDEC approved form,⁴ which contains the information identified in Part I.F.3. below, if:
 - a. seeking to continue to implement the technical/design components of the SMPs that were acceptable under GP-0-20-001;

⁴ Unless NYSDEC grants a waiver in accordance with 40 CFR 127.15(c) or (d). All waiver requests must be submitted to Stormwater_info@dec.ny.gov or NYSDEC, Bureau of Water Permits, 625 Broadway, 4th Floor, Albany, New York 12233-3505.

- b. such design was done in conformance with the technical standards in place at the time of initial permit coverage; and
 - c. the *owner or operator* will comply with all other requirements of GP-0-25-001.
3. The Request to Continue Coverage form contains questions to: ensure eligibility requirements in Part I.A. have been met; verify *owner or operator* contact information; verify the permit identification number; verify the original eNOI submission ID, if applicable; verify that the technical/design components of the SMPs have not changed; verify the version of the Design Manual that the technical/design components conform to; and receive an updated Owner/Operator Certification Form, Appendix I.
4. Upon receipt of the LOCC, which is sent by NYSDEC after a complete Request to Continue Coverage is submitted, *discharges to surface waters of the State* from the *construction activities* identified in the Request to Continue Coverage are authorized so long as the *owner or operator* maintains all requirements of this permit (excepting the technical/design components of the SMPs that were acceptable under GP-0-20-001).
5. Within 30 calendar days of the effective date of this permit, an *owner or operator* must submit a new eNOI in accordance with Part I.D. if an *owner or operator* of a *construction activity*, with coverage under GP-0-20-001, made or is making changes to the technical/design components of the SMPs.

G. Change of Owner or Operator

When applicable:

1. When property ownership changes, or when there is a change in operational control over the construction plans and specifications, the following process applies:
 - a. The new *owner or operator* must meet the applicable prerequisites for submitting an eNOI in accordance with Part I.D.2.
 - b. The new *owner or operator* must submit an eNOI in accordance with Part I.D.3.

- c. Permit coverage for the new *owner or operator* will be effective upon receipt of the LOA in accordance with Part I.D.3.b.
- d. The new *owner or operator*, upon receipt of their LOA, must provide their Permit ID to the original *owner or operator*.
- e. If the original *owner or operator* will no longer be the *owner or operator* of the *construction activity* identified in the original *owner's or operator's* eNOI, the original *owner or operator*, upon receipt of the new *owner's or operator's* Permit ID in accordance with Part I.G.1.d., must submit to NYSDEC a completed NOT in accordance with Part V. that includes the name and Permit ID of the new *owner or operator*.
- f. If the original *owner or operator* maintains ownership of a portion of the *construction activity*, the original *owner or operator* must maintain their coverage under the permit by amending the original eNOI; amendments to the eNOI must include:
 - i. the revised area of disturbance and/or *impervious area(s)*;
 - ii. the revised SMP information, if applicable;
 - iii. a narrative description of what has changed; and
 - iv. the new *owner's or operator's* Permit ID for the portion of the project removed from the eNOI.

To receive access to amend the original eNOI, contact:
Stormwater_info@dec.ny.gov

Part II. Water Quality-Based Effluent Limitations

A. Maintaining Water Quality

NYSDEC expects that compliance with the requirements of this permit will control *discharges* necessary to meet applicable *water quality standards*. It shall be a violation of the *ECL* for any *discharge* to either cause or contribute to a violation of the following *water quality standards* as contained in Parts 700 through 705 of Title 6 of the Official Compilation of Codes, Rules and Regulations of the State of New York:

1. There must be no increase in turbidity that will cause a substantial visible contrast to natural conditions;
2. There must be no increase in suspended, colloidal or settleable solids that will cause deposition or impair the waters for their best usages; and
3. There must be no residue from oil and floating substances, nor visible oil film, nor globules of grease.

If there is evidence indicating that the *stormwater discharges* authorized by this permit are causing, have the reasonable potential to cause, or are contributing to a violation of the *water quality standard*, the *owner or operator* must take appropriate corrective action in accordance with Part IV.C.5. of this permit and document in accordance with Part IV.C.4. of this permit. To address the *water quality standard* violation the *owner or operator* must include and implement appropriate controls in the *SWPPP* to correct the problem or obtain an individual SPDES permit.

If, despite compliance with the requirements of this permit, it is demonstrated that the *stormwater discharges* authorized by this permit are causing or contributing to a violation of *water quality standards*, or if NYSDEC determines that a modification of this permit is necessary to prevent a violation of *water quality standards*, the authorized *discharges* will no longer be eligible for coverage under this permit, and the *owner or operator* must obtain an individual SPDES permit prior to further *discharges* from the *construction site*.

B. Effluent Limitations Applicable to *Discharges* from *Construction Activities*

Discharges authorized by this permit must achieve, at a minimum, the effluent limitations in Part II.B.1.a., b., c., d., and e. These limitations represent the degree of effluent reduction attainable by the application of best practicable technology currently available.

1. Erosion and Sediment Control Requirements - The *owner or operator* must select, design, install, implement, and maintain control measures to *minimize* the *discharge of pollutants* and prevent a violation of the *water quality standards*. The selection, design, installation, implementation, and maintenance of these control measures must meet the non-numeric effluent limitations in Part II.B.1.a., b., c., d., and e. and be in accordance with the New York State Standards and Specifications for Erosion and Sediment Control (BB), dated November 2016, using sound engineering judgment. Where control measures are not designed in conformance with the design criteria included in the technical standard, the *owner or operator* must include in *SWPPP* the reason(s) for the deviation, or alternative design, and provide

information in the *SWPPP* demonstrating that the deviation or alternative design is *equivalent* to the technical standard.

- a. **Erosion and Sediment Controls.** At a minimum, erosion and sediment controls must be selected, designed, installed, implemented, and maintained to:
- (i) *Minimize* soil erosion through application of runoff control and soil stabilization control measure to *minimize pollutant discharges*;
 - (ii) Control *stormwater discharges*, including both peak flowrates and total *stormwater* volume, to *minimize* channel and *streambank* erosion and scour in the immediate vicinity of the *discharge* points;
 - (iii) *Minimize* the amount of soil exposed during *construction activity*;
 - (iv) *Minimize* the disturbance of *steep slope*;
 - (v) *Minimize* sediment *discharges* from the site;
 - (vi) Provide and maintain *natural buffers* around surface waters, direct *stormwater* to vegetated areas and maximize *stormwater* infiltration to reduce *pollutant discharges*, unless *infeasible*;
 - (vii) *Minimize* soil compaction. *Minimizing* soil compaction is not required where the intended function of a specific area of the site dictates that it be compacted;
 - (viii) Unless *infeasible*, preserve a sufficient amount of topsoil to complete soil restoration and establish a uniform, dense vegetative cover; and
 - (ix) *Minimize* dust. On areas of exposed soil, *minimize* dust through the appropriate application of water or other dust suppression techniques to control the generation of *pollutants* that could be discharged from the site.
- b. **Soil Stabilization.** In areas where soil disturbance activity has ceased, whether permanently or *temporarily ceased*, the application of soil stabilization measures must be initiated by the end of the next business day and completed within 14 calendar days from the date the current soil disturbance activity ceased. For *construction sites* that *directly discharge* to one of the 303(d) segments listed in Appendix D, or are located in one

of the watersheds listed in Appendix C, or are authorized to disturb greater than five acres in accordance with Part I.E.5.a.viii., the application of soil stabilization measures must be initiated by the end of the next business day and completed within seven calendar days from the date the soil disturbance activity ceased.

- c. **Dewatering.** *Discharges from dewatering activities, including discharges from dewatering of trenches and excavations, must be managed by appropriate control measures.*

- d. **Pollution Prevention Measures.** Select, design, install, implement, and maintain effective pollution prevention measures to *minimize the discharge of pollutants* and prevent a violation of the *water quality standards*. At a minimum, such measures must be selected, designed, installed, implemented, and maintained to:
 - (i) *Minimize the discharge of pollutants* from equipment and vehicle washing, wheel wash water, and other wash waters. Soaps, detergents and solvents cannot be used;

 - (ii) *Minimize the exposure of building materials, building products, construction wastes, trash, landscape materials, fertilizers, pesticides, herbicides, detergents, sanitary waste, hazardous and toxic waste, and other materials present on the site to precipitation and to stormwater. Minimization of exposure is not required in cases where the exposure to precipitation and to stormwater will not result in a discharge of pollutants, or where exposure of a specific material or product poses little risk of stormwater contamination (such as final products and materials intended for outdoor use); and*

 - (iii) Prevent the *discharge of pollutants* from spills and leaks and implement chemical spill and leak prevention and response procedures.

- e. **Surface Outlets.** When discharging from basins and impoundments, the surface outlets must be designed, constructed, and maintained in such a manner that sediment does not leave the basin or impoundment and that erosion at or below the outlet does not occur.

C. Post-Construction Stormwater Management Practice (SMP) Requirements

1. The *owner or operator* of a *construction activity* that requires post-construction SMPs, in accordance with Part III.C., must select, design, install, implement, and maintain the SMPs to meet the *performance criteria* in the New York State Stormwater Management Design Manual, dated July 31, 2024 (DM), using sound engineering judgment. Where SMPs are not designed in conformance with the *performance criteria* in the DM, the *owner or operator* must include in the *SWPPP* the reason(s) for the deviation or alternative design and provide information which demonstrates that the deviation or alternative design is *equivalent* to the technical standard.
2. The *owner or operator* of a *construction activity*, that requires SMPs in accordance with Part III.C., must design the practices to meet the applicable *sizing criteria* in Part II.C.2.a., b., c., or d.

a. Sizing Criteria for New Development

- i. Runoff Reduction Volume (RRv) and Water Quality Volume (WQv):
 1. Reduce the total WQv by application of RR techniques and standard SMPs with RRv capacity. The total WQv must be calculated in accordance with the criteria in Section 4.2 of the DM; or
 2. Minimum RRv and Treatment of Remaining Total WQv: *Construction activities* that cannot meet the requirements in Part II.C.2.a.i.1. due to *site limitations* must direct runoff from all newly constructed *impervious areas* to a RR technique or standard SMP with RRv capacity unless *infeasible*. The specific *site limitations* that prevent the reduction of 100% of the WQv must be documented in the *SWPPP*. For each *impervious area* that is not directed to a RR technique or standard SMP with RRv capacity, the *SWPPP* must include documentation which demonstrates that all options were considered and for each option explains why it is considered *infeasible*.

In no case shall the runoff reduction achieved from the newly constructed *impervious areas* be less than the Minimum RRv as calculated using the criteria in Section 4.4 of the DM. The remaining portion of the total WQv that cannot be reduced must be treated by application of standard SMPs.

- ii. Channel Protection Volume (CPv): Provide 24 hour extended detention of the post-developed 1-year, 24-hour storm event; remaining after runoff reduction. The CPv requirement does not apply when:
 - 1. Reduction of the entire CPv is achieved by application of runoff reduction techniques or infiltration systems; or
 - 2. The 1-year post-development peak *discharge* is less than or equal to 2.0 cfs without detention or velocity controls; or
 - 3. The site *directly discharges* into a fifth order or larger water body (stream, river, or lake), or tidal waters, where the increase in smaller flows will not impact the stream bank or channel integrity. However, the point of *discharge* must be adequately protected against scour and erosion by the increased peak *discharge*.
- iii. *Overbank* Flood Control Criteria (Qp): Requires storage to attenuate the post-development 10-year, 24-hour peak *discharge* rate (Qp) to predevelopment rates. The Qp requirement does not apply when:
 - 1. the site *directly discharges* to tidal waters or fifth order or larger streams, or
 - 2. A downstream analysis reveals that *overbank* control is not required.
- iv. Extreme Flood Control Criteria (Qf): Requires storage to attenuate the post-development 100-year, 24-hour peak *discharge* rate (Qf) to predevelopment rates. The Qf requirement does not apply when:
 - 1. the site *directly discharges* to tidal waters or fifth order or larger streams, or
 - 2. A downstream analysis reveals that *overbank* control is not required.

b. Sizing Criteria for New Development in Enhanced Phosphorus Removal Watershed

i. Runoff Reduction Volume (RRv) and Water Quality Volume (WQv):

1. Reduce the WQv by application of RR techniques and standard SMPs with RRv capacity. The total WQv is the runoff volume from the 1-year, 24-hour design storm over the post-developed watershed and must be calculated in accordance with the criteria in Section 4.3 of the DM; or
2. Minimum RRv and Treatment of Remaining Total WQv: *Construction activities* that cannot meet the criteria in Part II.C.2.b.i.1. due to *site limitations* must direct runoff from all newly constructed *impervious areas* to a RR technique or standard SMP with RRv capacity unless *infeasible*. The specific *site limitations* that prevent the reduction of 100% of the WQv must be documented in the *SWPPP*. For each *impervious area* that is not directed to a RR technique or standard SMP with RRv capacity, the *SWPPP* must include documentation which demonstrates that all options were considered and for each option explains why it is considered *infeasible*.

In no case shall the runoff reduction achieved from the newly constructed *impervious areas* be less than the Minimum RRv as calculated using the criteria in Section 4.5 of the DM. The remaining portion of the total WQv that cannot be reduced must be treated by application of standard SMPs.

ii. Channel Protection Volume (CPv): Provide 24 hour extended detention of the post-developed 1-year, 24-hour storm event; remaining after runoff reduction. The CPv requirement does not apply when:

1. Reduction of the entire CPv is achieved by application of runoff reduction techniques or infiltration systems; or
2. The 1-year post-development peak *discharge* is less than or equal to 2.0 cfs; or

3. A CPv control orifice is provided, with a minimum orifice size of 3 inches, with acceptable external rack or internal orifice protection; or
 4. The site *directly discharges* to tidal waters, or a fifth order or larger water body (stream, river, or lake) where the increase in smaller flows will not impact the stream bank or channel integrity. However, the point of *discharge* must be adequately protected against scour and erosion by the increased peak *discharge*.
- iii. **Overbank Flood Control Criteria (Qp):** Requires storage to attenuate the post-development 10-year, 24-hour peak *discharge* rate (Qp) to predevelopment rates. The Qp requirement does not apply when:
1. the site *directly discharges* to tidal waters or fifth order or larger streams; or
 2. A downstream analysis reveals that *overbank* control is not required.
- iv. **Extreme Flood Control Criteria (Qf):** Requires storage to attenuate the post-development 100-year, 24-hour peak *discharge* rate (Qf) to predevelopment rates. The Qf requirement does not apply when:
1. the site *directly discharges* to tidal waters or fifth order or larger streams; or
 2. A downstream analysis reveals that *overbank* control is not required.

c. Sizing Criteria for Redevelopment Activity

- i. **Water Quality Volume (WQv):** The WQv treatment objective for *redevelopment activity* must be addressed by one of the following options, as outlined in Section 9.2.1. *Redevelopment activities* located in an Enhanced Phosphorus Removal Watershed (see Part III.B.3. and Appendix C) must calculate the WQv in accordance with Section 4.3 of the DM. All other *redevelopment activities* must calculate the WQv in accordance with Section 4.2 of the DM.

1. Reduce the existing *impervious cover* by a minimum of 25% of the total disturbed, *impervious area*. The Soil Restoration criteria in Section 5.1.6 of the DM must be applied to all newly created pervious areas; or
2. Capture and treat 100% of the required WQv, for a minimum of 25% of the disturbed redevelopment *impervious area*, by implementation of standard SMPs or reduced by application of runoff reduction techniques; or
3. Capture and treat 100% of the required WQv, for a minimum of 75% of the disturbed redevelopment *impervious area*, by implementation of a volume-based alternative SMP, as defined in Section 9.4 of the DM; or
4. Capture and treat 100% of the required WQv, for a minimum of 75% of the disturbed redevelopment *impervious area*, by implementation of a flow-through alternative SMP sized to treat the peak rate of runoff from the WQv design storm; or
5. Application of a combination of 1 through 4 above that provide a weighted average of at least two of the above methods. Application of this method must be in accordance with the criteria in Section 9.2.1(A)(V) of the DM; or
6. If there is an existing SMP located on the site that captures and treats runoff from the *impervious area* that is being disturbed, the WQv treatment option selected must, at a minimum, provide treatment equal to the treatment that was being provided by the existing practice(s) if that treatment is greater than the treatment required by options 1 through 5 above.
 - ii. Channel Protection Volume (CPv) is not required if there is 0% change to hydrology that increases the *discharge* rate and volume from the project site.
 - iii. *Overbank* Flood Control (Qp) is not required if there is 0% change to hydrology that increases the *discharge* rate from the project site.
 - iv. Extreme Flood Control (Qf) is not required if there is 0% change to hydrology that increases the *discharge* rate from the project site.

d. *Sizing Criteria for Combination of Redevelopment Activity and New Development*

Construction projects, that include both *new development* and *redevelopment activity*, must use SMPs that meet the *sizing criteria* calculated as an aggregate of the *sizing criteria* in Part II.C.2.a. or b. for the *new development* portion of the project and Part II.C.2.c. for the *redevelopment activity* portion of the project.

Part III. Stormwater Pollution Prevention Plan (SWPPP)

A. General SWPPP Requirements

1. A *SWPPP* must be prepared and implemented by the *owner or operator* of all *construction activity* covered by this permit. All authorized *discharges* must be identified in the *SWPPP*. The *SWPPP* must document the selection, design, installation, implementation and maintenance of the control measures and practices that will be used to meet the effluent limitations in Part II.B. and, where applicable, the SMP requirements in Part II.C.
2. The *SWPPP* must demonstrate consideration of the future physical risks due to climate change pursuant to the Community Risk and Resiliency Act (CRRA), 6 NYCRR Part 490, and associated guidance (e.g., “Using Natural Measures to Reduce the Risk of Flooding and Erosion,” “State Flood Risk Management Guidance,” “Estimating Guideline Elevations,” and “Tidal Wetlands Guidance: Living Shoreline Techniques in the Marine District of New York State”).
 - a. The consideration must be in narrative format and meet Part III.A.2.a.i. and ii.
 - i. The consideration must address, at minimum, the following physical risks due to climate change:
 - (i) increasing temperature;
 - (ii) increasing precipitation;

- (iii) increasing variability in precipitation, including chance of drought;
 - (iv) increasing frequency and severity of flooding;
 - (v) rising sea level;
 - (vi) increasing storm surge; and
 - (vii) shifting ecology.
 - ii. The risks in Part III.A.2.a.i. must be addressed for each of the following:
 - (i) overall site planning; and
 - (ii) location, elevation, and sizing of:
 - a. control measures and practices;
 - b. conveyance system(s); and
 - c. detention system(s).
- 3. The *SWPPP* must describe the erosion and sediment control practices and where required, SMPs that will be used and/or constructed to reduce the *pollutants in stormwater discharges* and to assure compliance with the requirements of this permit. In addition, the *SWPPP* must identify potential sources of pollution which may reasonably be expected to affect the quality of *stormwater discharges*.
- 4. All *SWPPPs*, that require the SMP component in accordance with Part III.B.2., must be prepared by a *qualified professional*.
- 5. The *owner or operator* must keep the *SWPPP* current so that, at all times, it accurately documents the erosion and sediment control practices that are being used or will be used during construction, and all SMPs that will be constructed on the site. At a minimum, the *owner or operator* must amend the *SWPPP*, including construction drawings:
 - a. whenever the current provisions prove to be ineffective in *minimizing pollutants in stormwater discharges* from the site;

- b. whenever there is a change in design, construction, or operation at the *construction site* that has or could have an effect on the *discharge of pollutants*;
 - c. to address issues or deficiencies identified during an inspection by the *qualified inspector*, NYSDEC, or other regulatory authority; and
 - d. to document the final construction conditions in an as-built drawing.
6. NYSDEC may notify the *owner or operator* at any time that the *SWPPP* does not meet one or more of the minimum requirements of this permit. The notification must be in writing and identify the provisions of the *SWPPP* that require modification. Within fourteen (14) calendar days of such notification, or as otherwise indicated by NYSDEC, the *owner or operator* must make the required changes to the *SWPPP* and submit written notification to NYSDEC that the changes have been made. If the *owner or operator* does not respond to NYSDEC's comments in the specified time frame, NYSDEC may suspend the *owner's or operator's* coverage under this permit or require the *owner or operator* to obtain coverage under an individual SPDES permit in accordance with Part II.D.4.
7. Prior to the *commencement of construction activity*, the *owner or operator* must identify the contractor(s) and subcontractor(s) that will be responsible for installing, constructing, repairing, replacing, inspecting, and maintaining the erosion and sediment control practices included in the *SWPPP* and the contractor(s) and subcontractor(s) that will be responsible for constructing the SMPs included in the *SWPPP*. The *owner or operator* must have each of the contractors and subcontractors identify at least one person from their company to be *trained contractor* that will be responsible for implementation of the *SWPPP*. The *owner or operator* must ensure that at least one *trained contractor* is on site daily when soil disturbance activities are being performed.

The *owner or operator* must have each of the contractors and subcontractors identified above sign a copy of the following certification statement below before the *commencement of construction activities*:

"I hereby certify under penalty of law that I understand and agree to comply with the requirements of the *SWPPP* and agree to implement any corrective actions identified by the *qualified inspector* during a site inspection. I also understand that the *owner or operator* must comply with

the requirements of the most current version of the New York State Pollutant Discharge Elimination System (SPDES) Construction General Permit (CGP) for Stormwater Discharges from Construction Activities and that it is unlawful for any person to cause or contribute to a violation of *water quality standards*. Furthermore, I am aware that there are significant penalties for submitting false information, that I do not believe to be true, including the possibility of fine and imprisonment for knowing violations"

In addition to providing the certification statement above, the certification page must also identify the specific elements of the *SWPPP* that each contractor and subcontractor will be responsible for and include the name and title of the person providing the signature; the name and title of the *trained contractor* responsible for *SWPPP* implementation; the name, address and telephone number of the contracting firm; the address (or other identifying description) of the site; and the date the certification statement is signed. The *owner or operator* must attach the certification statement(s) to the copy of the *SWPPP* that is maintained at the *construction site*. If new or additional contractors are hired to implement measures identified in the *SWPPP* after the *commencement of construction activities*, they must also sign the certification statement and provide the information listed above prior to performing *construction activities*.

B. Required *SWPPP* Contents

1. Erosion and sediment control component - The *owner or operator* must prepare a *SWPPP* that includes erosion and sediment control practices.
 - a. Erosion and sediment control practices must be designed:
 - i. in conformance with the BB; or
 - ii. *equivalent* to the BB if deviating from Part III.B.1.a.i.
 - b. If the erosion and sediment control practices are designed in conformance with Part III.B.1.a.ii., the *SWPPP* must include a demonstration of *equivalence* to the BB.
 - c. At a minimum, the erosion and sediment control component of the *SWPPP* must include the following:

- i. Background information about the scope of the project, including the location, type and size of project;
- ii. A site map/construction drawing(s) with north arrows for the project, including a general location map. At a minimum, the site map must show the total site area; all improvements; areas of disturbance; areas that will not be disturbed; existing vegetation; on-site and adjacent off-site surface water(s); floodplain/floodway boundaries; wetlands and drainage patterns that could be affected by the *construction activity*; existing and final contours; locations of different soil types with boundaries; material, waste, borrow or equipment storage areas located on adjacent properties; and location(s) of the *stormwater discharge(s)* and receiving surface water(s);
- iii. A description of the soil(s) present at the site, including an identification of the Hydrologic Soil Group (HSG);
- iv. A phasing plan for the project and sequencing plans for all *phases*, both of which must address clearing and grubbing, excavation and grading, utility and infrastructure installation, *final stabilization*, and any other *construction activity* at the site that will result in soil disturbance.
 1. The phasing plan must include:
 - a. a map delineating and labeling the limits of soil disturbance for all *phases* of a project; and
 - b. a table identifying the order and intended schedule of when each *phase* will begin and end its sequencing plan. The table must identify the total disturbed area for each *phase* at any one time and the total disturbed area for the overall project at any one time all on one timeline showing all overlapping quantities of disturbed area at any one time.
 2. A sequencing plan for a specific *phase* must include:
 - a. a table indicating the order and intended schedule of *construction activities* within a *phase*, and

- corresponding construction drawings with a description of the work to be performed;
- b. all proposed cuts and fills delineated in plan view and quantified numerically; and
 - c. all permanent and *temporary stabilization* measures.
- v. A description of the minimum erosion and sediment control practices to be installed or implemented for each *construction activity* that will result in soil disturbance. Include a schedule that identifies the timing of initial placement or implementation of each erosion and sediment control practice and the minimum time frames that each practice should remain in place or be implemented;
 - vi. A site map/construction drawing(s) showing the specific location(s), size(s), and length(s) of each erosion and sediment control practice;
 - vii. The dimensions, material specifications, installation details, and operation and maintenance requirements for all erosion and sediment control practices. Include the location and sizing of any temporary sediment basins and structural practices that will be used to divert flows from exposed soils;
 - viii. A maintenance inspection schedule for the contractor(s) and subcontractor(s) identified in Part III.A.7. to ensure continuous and effective operation of the erosion and sediment control practices. The maintenance inspection schedule must be in accordance with the requirements in the BB technical standard;
 - ix. A description of the pollution prevention measures that will be used to control litter, construction chemicals and construction debris from becoming a *pollutant* source in the *stormwater discharges*;
 - x. A description and location of any *stormwater discharges* associated with industrial activity other than construction at the site, including, but not limited to, *stormwater discharges* from asphalt plants and concrete plants located on the *construction site*; and

- xi. Identification of any elements of the design that are not in conformance with the design criteria in the BB technical standard. Include the reason for the deviation or alternative design and provide information which demonstrates that the deviation or alternative design is *equivalent* to the technical standard.
2. SMP component – The *owner or operator of construction activity* identified in Table 2 of Appendix B must prepare a *SWPPP* that includes SMPs.
- a. SMPs must be designed in conformance with the applicable *sizing criteria* in Part II.C.2.a., c., or d.
 - b. SMPs must be designed in conformance with the *performance criteria*:
 - i. in the DM; or
 - ii. *equivalent* to the DM if deviating from Part III.B.2.a.i.; or
 - iii. in the New York State Stormwater Management Design Manual, dated January 2015 (2015 Design Manual), or *equivalent* to it, if the following criteria are met:
 - 1. The construction activities are subject to governmental review and approval, where the *owner or operator* made any application to that governmental entity prior to the effective date of this permit;
 - 2. Such application included a *SWPPP* developed using the 2015 Design Manual or *equivalent* to it; and
 - 3. The eNOI is submitted in accordance with Part I.D. before January 29, 2027.
 - c. If SMPs are designed in conformance with Part III.B.2.b.ii., the *SWPPP* must include the reason(s) for the deviation or alternative design and a demonstration of *equivalence* to the DM.
 - d. If SMPs are designed in conformance with Part III.B.2.b.iii., the *SWPPP* must include supporting information or documentation demonstrating that Part III.B.2.b.iii.1., 2., and 3. apply.

- e. The SMP component of the *SWPPP* must include the following:
- i. Identification of all SMPs to be constructed as part of the project. Include the dimensions, material specifications and installation details for each SMP;
 - ii. A site map/construction drawing(s) showing the specific location and size of each SMP;
 - iii. A Stormwater Modeling and Analysis Report that includes:
 - (i) Map(s) showing pre-development conditions, including watershed/subcatchments boundaries, flow paths/routing, and design points;
 - (ii) Map(s) showing post-development conditions, including watershed/subcatchments boundaries, flow paths/routing, design points and SMPs;
 - (iii) Results of *stormwater* modeling (i.e. hydrology and hydraulic analysis) for the required storm events. Include supporting calculations (model runs), methodology, and a summary table that compares pre- and post-development runoff rates and volumes for the different storm events;
 - (iv) Summary table, with supporting calculations, which demonstrates that each SMP has been designed in conformance with the *sizing criteria* included in the DM;
 - (v) Identification of any *sizing criteria* that is not required based on the requirements included in Part II.C.; and
 - (vi) Identification of any elements of the design that are not in conformance with the *performance criteria* in the DM. Include the reason(s) for the deviation or alternative design and provide information which demonstrates that the deviation or alternative design is *equivalent* to the DM.
 - iv. Soil testing results and locations (test pits, borings);

- v. Infiltration test results, when required in accordance with Part III.B.2.a.; and
 - vi. An operations and maintenance plan that includes inspection and maintenance schedules and actions to ensure continuous and effective operation of each SMP. The plan must identify the entity that will be responsible for the long-term operation and maintenance of each practice.
3. Enhanced Phosphorus Removal Standards - The *owner or operator of construction activity* identified in Table 2 of Appendix B that is located in a watershed identified in Appendix C must prepare a *SWPPP* that includes SMPs designed in conformance with the applicable *sizing criteria* in Part II.C.2.b., c., or d. and the *performance criteria* Enhanced Phosphorus Removal Standards included in the DM. At a minimum, the SMP component of the *SWPPP* must meet the requirements of Part III.B.2.

C. Required *SWPPP* Components by Project Type

Owners or operators of construction activities, identified in Table 1 of Appendix B, are required to prepare a *SWPPP* that only includes erosion and sediment control practices designed in accordance with Part III.B.1. *Owners or operators of the construction activities*, identified in Table 2 of Appendix B, must prepare a *SWPPP* that also includes SMPs designed in accordance with Part III.B.2 or 3.

Part IV. Inspection and Maintenance Requirements

A. General Construction Site Inspection and Maintenance Requirements

1. The *owner or operator* must ensure that all erosion and sediment control practices (including pollution prevention measures), and all SMPs identified in the *SWPPP*, are inspected and maintained in accordance with Part IV.B. and C.

B. Contractor Maintenance Inspection Requirements

1. The *owner or operator of each construction activity*, identified in Tables 1 and 2 of Appendix B, must have a *trained contractor* inspect the erosion and sediment control practices and pollution prevention measures being implemented within the active work area daily to ensure that they are being

maintained in effective operating condition at all times. If deficiencies are identified, the contractor must:

- a. begin implementing corrective actions within one business day; and
 - b. complete the corrective actions within five business days or, if the corrective action requires engineering design, within 15 business days.
2. For *construction sites* where soil disturbance activities have been temporarily suspended (e.g. winter shutdown) and *temporary stabilization* measures have been applied to all disturbed areas, the *trained contractor* can stop conducting the maintenance inspections in accordance with Part IV.B.1. The *trained contractor* must begin conducting the maintenance inspections in accordance with Part IV.B.1. as soon as soil disturbance activities resume.
 3. For *construction sites* where soil disturbance activities have been shut down with partial project completion, the *trained contractor* can stop conducting the maintenance inspections in accordance with Part IV.B.1. if all areas disturbed as of the project shutdown date have achieved *final stabilization* and all SMPs required for the completed portion of the project have been constructed in conformance with the *SWPPP* and are operational.

C. Qualified Inspector Inspection Requirements

1. With the exception of the following *construction activities* identified in Tables 1 and 2 of Appendix B, a *qualified inspector* must conduct site inspections for all other *construction activities* identified in Tables 1 and 2 of Appendix B:
 - a. the construction of a single-family residential subdivision with 25% or less *impervious cover* at total site build-out that involves a soil disturbance of one (1) or more acres of land but less than or equal to five (5) acres and is not located in one of the watersheds listed in Appendix C and not directly discharging to one of the 303(d) segments listed in Appendix D;
 - b. the construction of a single-family home that involves soil disturbances of one (1) or more acres but less than or equal to five (5) acres and is not located in one of the watersheds listed in Appendix C and not directly discharging to one of the 303(d) segments listed in Appendix D;
 - c. construction on *agricultural property* that involves soil disturbances of one (1) or more acres but less than five (5) acres; and

- d. *construction activities* located in the New York City Watershed located east of the Hudson River, see Appendix C Figure 1, that involve soil disturbances of 5,000 square feet or more, but less than one acre.
2. The *qualified inspector* must conduct site inspections in accordance with the following timetable:
 - a. For *construction sites* where soil disturbance activities are on-going, the *qualified inspector* must conduct a site inspection at least once every seven (7) calendar days.
 - b. For *construction sites* where soil disturbance activities are on-going and the *owner or operator* has received authorization in accordance with Part II.D.3 to disturb greater than five (5) acres of soil at any one time, the *qualified inspector* must conduct at least two (2) site inspections every seven (7) calendar days. The two (2) inspections must be separated by a minimum of two (2) full calendar days.
 - c. For *construction sites* where soil disturbance activities have been temporarily suspended (e.g. winter shutdown) and *temporary stabilization* measures have been applied to all disturbed areas, the *qualified inspector* must conduct a site inspection at least once every thirty (30) calendar days. The *owner or operator* must notify the DOW Water (SPDES) Program contact at the Regional Office (see contact information in Appendix E) or, in areas under the jurisdiction of a *Traditional Land Use Control MS4 Operator*, the *Traditional Land Use Control MS4 Operator* (provided the *Traditional Land Use Control MS4 Operator* is not the *owner or operator* of the *construction activity*) by hard copy or email prior to reducing the inspections to this frequency and again by hard copy or email prior to re-commencing construction.
 - d. For *construction sites* where soil disturbance activities have been shut down with partial project completion, the requirement to have the *qualified inspector* conduct inspections ceases if all areas disturbed as of the project shutdown date have achieved *final stabilization* and all SMPs required for the completed portion of the project have been constructed in conformance with the *SWPPP* and are operational. The *owner or operator* must notify the DOW Water (SPDES) Program contact at the Regional Office (see contact information in Appendix E) or, in areas subject to the review authority of *Traditional Land Use Control MS4 Operator(s)* in accordance with Part I.D.2.b.ii.1., the *Traditional Land Use Control MS4 Operator(s)* (provided the *Traditional Land Use Control MS4 Operator(s)*

are not the *owners or operators* of the *construction activity*) in writing prior to the shutdown and again in writing prior to resuming *construction activity*. If soil disturbance activities are not resumed within 2 years from the date of shutdown, the *owner or operator* must terminate coverage by meeting the requirements of Part V.

- e. For *construction sites* involving soil disturbance of one (1) or more acres that *directly discharge* to one of the 303(d) segments listed in Appendix D or is located in one of the watersheds listed in Appendix C, the *qualified inspector* must conduct at least two (2) site inspections every seven (7) calendar days. The two (2) inspections must be separated by a minimum of two (2) full calendar days.
3. At a minimum, the *qualified inspector* must inspect:
 - a. all erosion and sediment control practices and pollution prevention measures to ensure integrity and effectiveness;
 - b. all SMPs under construction to ensure that they are constructed in conformance with the *SWPPP*;
 - c. all areas of disturbance that have not achieved *final stabilization*;
 - d. all points of *discharge* to *surface waters of the State* located within, or immediately adjacent to, the property boundaries of the *construction site*; and
 - e. all points of *discharge* from the *construction site*.
 4. The *qualified inspector* must prepare an inspection report subsequent to each and every inspection. At a minimum, the inspection report must include and/or address all of the following, for all *construction activities* except those listed in Part IV.C.1.:
 - a. Permit identification number;
 - b. Date and time of inspection;
 - c. Name and title of person(s) performing inspection;

- d. A description of the weather and soil conditions (e.g. dry, wet, saturated) at the time of the inspection, including the temperature at the time of the inspection;
- e. A description of the condition of the runoff at all points of *discharge* from the *construction site*. This must include identification of any *discharges* of sediment from the *construction site*. Include *discharges* from conveyance systems (i.e. pipes, culverts, ditches, etc.) and overland flow;
- f. A description of the condition of all *surface waters of the State* located within, or immediately adjacent to, the property boundaries of the *construction site* which receive runoff from disturbed areas. This must include identification of any *discharges* of sediment to the *surface waters of the State*;
- g. Identification of all erosion and sediment control practices and pollution prevention measures that need repair or maintenance;
- h. Identification of all erosion and sediment control practices and pollution prevention measures that were not installed properly or are not functioning as designed and need to be reinstalled or replaced;
- i. Description and sketch (map) of areas with active soil disturbance activity, areas that have been disturbed but are inactive at the time of the inspection, and areas that have been stabilized (temporary and/or final) since the last inspection;
- j. Total area of soil disturbance (acres) at the time of the inspection;
- k. Current stage of construction of all SMPs and identification of all *construction activity* on site that is not in conformance with the *SWPPP* and technical standards;
- l. Corrective action(s) that must be taken to install, repair, replace or maintain erosion and sediment control practices and pollution prevention measures; and to correct deficiencies identified with the construction of the SMP(s);
- m. Identification and status of all corrective actions that were required by previous inspection; and

- n. Digital photographs, with date stamp, that clearly show the condition of all practices that have been identified as needing corrective actions. The *qualified inspector* must attach color copies of the digital photographs to the inspection report being maintained onsite within seven (7) calendar days of the date of the inspection. The *qualified inspector* must also take digital photographs, with date stamp, that clearly show the condition of the practice(s) after the corrective action has been completed. The *qualified inspector* must attach paper color copies of the digital photographs to the inspection report that documents the completion of the corrective action work within seven (7) calendar days of that inspection.
5. Within one business day of the completion of an inspection, the *qualified inspector* must notify the *owner or operator*, and appropriate contractor or subcontractor identified in Part III.A.7., of any corrective actions that need to be taken. The contractor or subcontractor must:
 - a. begin implementing corrective actions within one business day; and
 - b. complete the corrective actions within five business days or, if the corrective action requires engineering design, within 15 business days.
6. All inspection reports must be signed by the *qualified inspector*. In accordance with Part I.E.3., the inspection reports must be maintained on site with the *SWPPP*.

Part V. How to Terminate CGP Coverage

A. Electronic Notice of Termination (eNOT) Submittal

1. An *owner or operator* must terminate coverage when one or more of the following requirements have been met:
 - a. Total project completion:
 - i. all *construction activity* identified in the *SWPPP* has been completed;
 - ii. all areas of disturbance have achieved *final stabilization*;
 - iii. all temporary, structural erosion and sediment control measures have been removed;

- iv. all SMPs have been constructed in conformance with the *SWPPP* and are operational; and
 - v. an as-built drawing has been prepared; or
 - b. Planned shutdown with partial project completion:
 - i. all soil disturbance activities have ceased;
 - ii. all areas disturbed as of the project shutdown date have achieved *final stabilization*;
 - iii. all temporary, structural erosion and sediment control measures have been removed;
 - iv. all SMPs required for the completed portion of the project have been constructed in conformance with the *SWPPP* and are operational; and
 - v. an as-built drawing has been prepared; or
 - c. In accordance with Part I.G. Change of Owner or Operator; or
 - d. The *owner or operator* has obtained coverage under an alternative general SPDES permit or an individual SPDES permit.
- 2. For *construction activities* that require *qualified inspector* inspections in accordance with Part IV.C.1. and have met Part V.A.1.a. or b., the *owner or operator* must have the *qualified inspector* perform a final site inspection prior to submitting the eNOT. The *qualified inspector* must, by signing the “Final Stabilization” and “Post-Construction Stormwater Management Practice(s)” certification statements on the eNOT, certify that all the requirements in Part V.A.1.a. or b. have been achieved.
- 3. For *construction activities* that are subject to the review authority of *Traditional Land Use Control MS4 Operator(s)* in accordance with Part I.D.2.b.ii.1. and meet Part V.A.1.a. or b., the *owner or operator* must have the *Traditional Land Use Control MS4 Operator(s)* sign the “MS4 Acceptance” statement on the eNOT in accordance with the requirements in Part VII.J. A *Traditional Land Use Control MS4 Operator* official, by signing this statement, determined that it is acceptable for the *owner or operator* to submit the eNOT

in accordance with the requirements of this Part. A *Traditional Land Use Control MS4 Operator* can make this determination by performing a final site inspection themselves or by accepting the *qualified inspector's* final site inspection certification(s) when required in Part V.A.2.

4. For *construction activities* that require SMPs and meet Part V.A.1.a., the *owner or operator* must, prior to submitting the eNOT, ensure one of the following:
 - a. for SMP(s) that were constructed by a private entity, but will be owned, operated, and maintained by a public entity, the SMP(s) and any right-of-way(s) needed to operate and maintain such practice(s) have been deeded to the municipality in which the practice(s) is located; or
 - b. for SMP(s) that are privately owned, but will be operated and maintained by a public entity, an executed operation and maintenance agreement is in place with the municipality that will operate and maintain the SMP(s); or
 - c. for SMP(s) that are privately owned, the *owner or operator* has a mechanism in place that requires operation and maintenance of the practice(s) in accordance with the operation and maintenance plan, such as a deed covenant in the *owner or operator's* deed of record; or
 - d. for SMP(s) that are owned by a public or private institution (e.g. school, university, hospital), government agency or authority, or public utility, the *owner or operator* has policies and procedures in place that ensure operation and maintenance of the practices in accordance with the operation and maintenance plan.
5. An *owner or operator* that has met the requirements of Part V.A.1., 2., 3., and 4. must request termination of coverage under this permit by submitting a complete Notice of Termination form electronically using a NYSDEC approved form.⁵

Part VI. Record Retention and Reporting

A. Record Retention

⁵ Unless NYSDEC grants a waiver in accordance with 40 CFR 127.15(c) or (d). All waiver requests must be submitted to Stormwater_info@dec.ny.gov or NYSDEC, Bureau of Water Permits, 625 Broadway, 4th Floor, Albany, New York 12233-3505.

The *owner or operator* must retain a copy of the documents listed in Part I.E.3. for a period of at least five years from the date that NYSDEC accepts a complete NOT submitted in accordance with Part V.

B. Reporting

Except for the eNOI, the signature forms associated with the eNOI, and the NOT, all other written correspondence requested by NYSDEC, including individual permit applications, must be sent to the address of the appropriate DOW (SPDES) Program contact at the Regional Office listed in Appendix E.

Part VII. Standard Permit Requirements

For the purposes of this permit, examples of contractors and subcontractors include: third-party maintenance and construction contractors.

A. Duty to Comply

The *owner or operator*, and all contractors or subcontractors, must comply with all requirements of this permit. Any non-compliance with the requirements of this permit constitutes a violation of the New York State Environmental Conservation Law (ECL), and its implementing regulations, and is grounds for enforcement action. Filing of a request for termination of coverage under this permit, or a notification of planned changes or anticipated non-compliance, does not limit, diminish or stay compliance with any requirements of this permit.

B. Need to Halt or Reduce Activity Not a Defense

The necessity to halt or reduce the *construction activity* regulated by this permit, in order to maintain compliance with the requirements of this permit, must not be a defense in an enforcement action.

C. Penalties

There are substantial criminal, civil, and administrative penalties associated with violating the requirements of this permit. Fines of up to \$37,500 per day for each violation and imprisonment for up to 15 years may be assessed depending upon the nature and degree of the offense.

D. False Statements

Any person who knowingly makes any false material statement, representation, or certification in any application, record, report, or other document filed or required to be maintained under this permit, including monitoring reports or reports of compliance or noncompliance must, upon conviction, be punished in accordance with ECL §71-1933 and or New York State Penal Law Articles 175 and 210.

E. Re-Opener Clause

Upon issuance of this permit, a determination has been made on the basis of a submitted Notice of Intent, plans, or other available information, that compliance with the specified permit requirements will reasonably protect classified water use and assure compliance with applicable *water quality standards*. Satisfaction of the requirements of this permit notwithstanding, if operation pursuant to this permit causes or contributes to a condition in contravention of State *water quality standards* or guidance values, or if NYSDEC determines that a modification is necessary to prevent impairment of the best use of the waters or to assure maintenance of *water quality standards* or compliance with other provisions of ECL Article 17 or the Clean Water Act (CWA), or any regulations adopted pursuant thereto, NYSDEC may require such modification and the Commissioner may require abatement action to be taken by the *owner or operator* and may also prohibit such operation until the modification has been implemented.

F. Duty to Mitigate

The *owner or operator*, and its contractors and subcontractors, must take all reasonable steps to *minimize* or prevent any *discharge* in violation of this permit which has a reasonable likelihood of adversely affecting human health or the environment.

G. Requiring Another General Permit or Individual SPDES Permit

NYSDEC may require any *owner or operator* authorized to *discharge* in accordance with this permit to apply for and obtain an individual SPDES permit or apply for authorization to *discharge* in accordance with another general SPDES permit.

1. Cases where an individual SPDES permit or authorization to discharge in accordance with another general SPDES permit may be required include, but is not limited to the following:
 - a. the *owner or operator* is not in compliance with the conditions of this permit or does not meet the requirements for coverage under this permit;

- b. a change has occurred in the availability of demonstrated technology or practices for the control or abatement of *pollutants* applicable to the *point source*;
 - c. new effluent limitation guidelines or new source performance standards are promulgated that are applicable to *point sources* authorized to *discharge* in accordance with this permit;
 - d. existing effluent limitation guidelines or new source performance standards that are applicable to *point sources* authorized to *discharge* in accordance with this permit are modified;
 - e. a water quality management plan containing requirements applicable to such *point sources* is approved by NYSDEC;
 - f. circumstances have changed since the time of the request to be covered so that the *owner or operator* is no longer appropriately controlled under this permit, or either a temporary or permanent reduction or elimination of the authorized *discharge* is necessary;
 - g. the *discharge* is in violation of section 17-0501 of the ECL; and
 - h. the *discharge(s)* is a significant contributor of *pollutants*. In making this determination, NYSDEC may consider the following factors:
 - i. the location of the *discharge(s)* with respect to *surface waters of the State*;
 - ii. the size of the *discharge(s)*;
 - iii. the quantity and nature of the *pollutants discharged to surface waters of the State*; and
 - iv. other relevant factors including compliance with other provisions of ECL Article 17, or the CWA.
2. When NYSDEC requires any *owner or operator* authorized by this permit to apply for an individual SPDES permit as provided for in this subdivision, it must notify the *owner or operator* in writing that a permit application is required. This notice must include a brief statement of the reasons for this decision, an application form, a statement setting a time for the *owner or operator* to file the application for an individual SPDES permit, and a deadline, not sooner than 180 days from the *owner's or operator's* receipt of the notification letter, whereby the authorization to *discharge* under this permit must be terminated. NYSDEC may

grant additional time upon demonstration, to the satisfaction of the RWE,⁶ that additional time to apply for an alternative authorization is necessary or where NYSDEC has not provided a permit determination in accordance with 6 NYCRR Part 621.

3. When an individual SPDES permit is issued to an *owner or operator* authorized to *discharge* under this permit for the same *discharge(s)*, this permit authorization for *construction activities* authorized under the individual SPDES permit is automatically terminated on the effective date of the individual SPDES permit unless termination is earlier in accordance with 6 NYCRR Part 750.

H. Duty to Provide Information

The *owner or operator* must furnish to NYSDEC, within five business days, unless otherwise set forth by NYSDEC, any information that NYSDEC may request to determine whether cause exists to determine compliance with this permit or to determine whether cause exists for requiring an individual SPDES permit in accordance with 6 NYCRR 750-1.21(e) (see Part VII.G. Requiring Another General Permit or Individual Permit).

The *owner or operator* must make available to NYSDEC, for inspection and copying, or furnish to NYSDEC within 25 business days of receipt of a NYSDEC request for such information, any information retained in accordance with this permit.

Except for Part I.D.4. and 5. and Part I.G., the following applies: where the *owner or operator* becomes aware that it failed to submit any relevant facts on the Notice of Intent, or submitted incorrect information in a Notice of Intent or in any report to NYSDEC, the *owner or operator* must submit such facts or corrected information to NYSDEC within five business days.

I. Extension

In the event a new permit is not issued and effective prior to the expiration of this permit, and this permit is extended pursuant to the State Administrative Procedure Act and 6 NYCRR Part 621, then the *owner or operator* with coverage under this permit may continue to operate and *discharge* in accordance with the requirements of this permit until a new permit is issued and effective.

J. Signatories and Certification

The Notice of Intent, Notice of Termination, and reports required by this permit must be signed as provided in 40 CFR §122.22.

⁶ The Regional Water Manager where a DEC Region does not have a RWE.

1. All Notices of Intent and Notices of Termination must be signed as follows:

a. For a corporation. By a responsible corporate officer. For the purpose of this section, a responsible corporate officer means:

- (i) a president, secretary, treasurer, or vice-president of the corporation in charge of a principal business function, or any other person who performs similar policy- or decision-making functions for the corporation; or
- (ii) the manager of one or more manufacturing, production or operating facilities, provided, the manager is authorized to make management decisions which govern the operation of the regulated facility including having the explicit or implicit duty of making major capital investment recommendations, and initiating and directing other comprehensive measures to assure long term environmental compliance with environmental laws and regulations; the manager can ensure that the necessary systems are established or actions taken to gather complete and accurate information for Notice of Intent or Notice of Termination requirements; and where authority to sign documents has been assigned or delegated to the manager in accordance with corporate procedures.

Note: NYSDEC does not require specific assignments or delegations of authority to responsible corporate officers identified in 40 CFR §122.22(a)(1)(i). NYSDEC will presume that these responsible corporate officers have the requisite authority to sign the Notice of Intent or Notice of Termination unless the corporation has notified NYSDEC to the contrary. Corporate procedures governing authority to sign a Notice of Intent or Notice of Termination may provide for assignment or delegation to applicable corporate positions under 40 CFR §122.22(a)(1)(ii) rather than to specific individuals.

b. For a partnership or sole proprietorship. By a general partner or the proprietor, respectively.

c. For a municipality, State, Federal, or other public agency. By either a principal executive officer or ranking elected official. For purposes of this section, a principal executive officer of a Federal agency includes:

- 1. the chief executive officer of the agency; or

2. a senior executive officer having responsibility for the overall operations of a principal geographic unit of the agency (e.g., Regional Administrators of EPA).
2. All reports required by this permit, and other information requested by NYSDEC, must be signed by a person described in Part VII.J.1., or by a duly authorized representative of that person. A person is a duly authorized representative only if:
 - a. The authorization is made in writing by a person described in Part VII.J.1. or using the Duly Authorized Form, Appendix J;
 - b. The authorization specifies either an individual or a position having responsibility for the overall operation of the regulated facility or activity, position of equivalent responsibility, or an individual or position having overall responsibility for environmental matters for the company. (A duly authorized representative may thus be either a named individual or any individual occupying a named position); and
 - c. The written authorization is submitted to NYSDEC.
3. Changes to authorization. If an authorization under Part VII.J.2. is no longer accurate because a different individual or position has responsibility for the overall operation of the *construction activity*, a new authorization satisfying the requirements of Part VII.J.2. must be submitted to NYSDEC prior to or together with any reports, information, or applications to be signed by an authorized representative.
4. Certification. Any person signing a document under Part VII.J.1. or 2. must make the following certification:

I certify under penalty of law that this document and all attachments were prepared under my direction or supervision in accordance with a system designed to assure that qualified personnel properly gather and evaluate the information submitted. Based on my inquiry of the person or persons who manage the system, or those persons directly responsible for gathering the information, the information submitted is, to the best of my knowledge and belief, true, accurate, and complete. I am aware that there are significant penalties for submitting false information, including the possibility of fine and imprisonment for knowing violations.

5. Electronic reporting. If documents described in Part VII.J.1. or 2. are submitted electronically by or on behalf of the *construction activity* with coverage under this permit, any person providing the electronic signature for such documents must meet all relevant requirements of this section, and must ensure that all of the relevant requirements of 40 CFR Part 3 (including, in all cases, subpart D to Part 3) (Cross-Media Electronic Reporting) and 40 CFR Part 127 (NPDES Electronic Reporting Requirements) are met for that submission.

K. Inspection and Entry

The *owner or operator* must allow NYSDEC, the USEPA Regional Administrator, the applicable county health department, or any authorized representatives of those entities, or, in the case of a *construction site* which *discharges* through an *MS4*, an authorized representative of the *MS4* receiving the *discharge*, upon the presentation of credentials and other documents as may be required by law, to:

1. enter upon the *owner's or operator's* premises where a regulated facility or activity is located or conducted or where records must be kept under the requirements of this permit;
2. have access to and copy at reasonable times, any records that must be kept under the requirements of this permit, including records required to be maintained for purposes of operation and maintenance;
3. inspect at reasonable times any facilities, equipment (including monitoring and control equipment), practices or operations regulated or required under this permit;
4. sample or monitor at reasonable times, for the purposes of assuring general SPDES permit compliance or as otherwise authorized by the CWA or ECL, any substances or parameters at any location; and
5. enter upon the property of any contributor to the regulated facility or activity under authority of the *owner or operator*.

L. Confidentiality of Information

The following must not be held confidential: this permit, the fact sheet for this permit, the name and address of any *owner or operator*, effluent data, the Notice of Intent, and information regarding the need to obtain an individual permit or an alternative general SPDES permit. This includes information submitted on forms themselves and any attachments used to supply information required by the forms (except

information submitted on usage of substances). Upon the request of the *owner or operator*, NYSDEC must make determinations of confidentiality in accordance with 6 NYCRR Part 616, except as set forth in the previous sentence. Any information accorded confidential status must be disclosed to the Regional Administrator upon his or her written request. Prior to disclosing such information to the Regional Administrator, NYSDEC will notify the Regional Administrator of the confidential status of such information.

M. Other Permits May Be Required

Nothing in this permit relieves the *owner or operator* from a requirement to obtain any other permits required by law.

N. NYSDEC Orders or Civil Decrees/Judgments

The issuance of this permit by the NYSDEC, and the coverage under this permit by the *owner or operator*, does not supersede, revoke, or rescind any existing order on consent or civil Decree/Judgment, or modification to any such documents or to any order issued by the Commissioner, or any of the terms, conditions, or requirements contained in such order or modification therefore, unless expressly noted.

O. Property Rights

Coverage under this permit does not convey any property rights in either real or personal property, or any exclusive privileges, nor does it authorize any injury to private property or any invasion of personal rights, nor any infringement of Federal, State, or local laws or regulations, nor does it obviate the necessity of obtaining the assent of any other jurisdiction as required by law for the *discharge* authorized.

P. Compliance with Interstate Standards

If the *construction activity* covered by this permit originates within the jurisdiction of an interstate water pollution control agency, then the *construction activity* must also comply with any applicable effluent standards or *water quality standards* promulgated by that interstate agency and as set forth in this permit for such *construction activities*.

Q. Oil and Hazardous Substance Liability

Coverage under this permit does not affect the imposition of responsibilities upon, or the institution of any legal action against, the *owner or operator* under section 311 of the CWA, which must be in conformance with regulations promulgated pursuant to section 311 governing the applicability of section 311 of the CWA to *discharges* from

facilities with *NPDES* permits, nor must such issuance preclude the institution of any legal action or relieve the *owner or operator* from any responsibilities, liabilities, or penalties to which the *owner or operator* is or may be subject pursuant to the Comprehensive Environmental Response, Compensation and Liability Act of 1980, 42 U.S.C. section 9601 et seq. (CERCLA).

R. Severability

The provisions of this permit are severable, and if any provision of this permit, or the application of any provision of this permit to any circumstance, is held invalid, the application of such provision to other circumstances, and the remainder of this permit, must not be affected thereby.

S. NYSDEC Approved Forms

The *owner or operator* must provide all relevant information that is requested by NYSDEC, and required by this permit, on all NYSDEC approved forms.

DRAFT

APPENDIX A – Abbreviations and Definitions

Abbreviations

APO – Agency Preservation Officer
BB – New York State Standards and Specifications for Erosion and Sediment Control (Blue Book), dated November 2016
BMP – Best Management Practice
DM – New York State Stormwater Management Design Manual (Design Manual), dated July 31, 2024
CPESC – Certified Professional in Erosion and Sediment Control
CPv – Channel Protection Volume
CWA – Clean Water Act (or the Federal Water Pollution Control Act, 33 U.S.C. §1251 et seq)
DOW – Division of Water
EAF – Environmental Assessment Form
ECL – chapter 43-B of the Consolidated Laws of the State of New York, entitled the Environmental Conservation Law
EPA – U.S. Environmental Protection Agency
HSG – Hydrologic Soil Group
MS4 – Municipal Separate Storm Sewer System
NOI – Notice of Intent
NOT – Notice of Termination
NPDES – National Pollutant Discharge Elimination System
NYCDEP – The City of New York Department of Environmental Protection
NYSDEC – The New York State Department of Environmental Conservation
OPRHP – Office of Parks, Recreation and Historic Places
Qf – Extreme Flood
Qp – Overbank Flood
RR – Runoff Reduction
RRv – Runoff Reduction Volume
RWE – Regional Water Engineer
SEQR – State Environmental Quality Review Act
SHPA – State Historic Preservation Act
SMP – Post-Construction Stormwater Management Practice
SPDES – State Pollutant Discharge Elimination System
SWPPP – Stormwater Pollution Prevention Plan
TMDL – Total Maximum Daily Load
UPA – Uniform Procedures Act
USDA – United States Department of Agriculture
WQv – Water Quality Volume

Definitions

All definitions in this section are solely for the purposes of this permit. If a word is not italicized in the permit, use its common definition.

Agricultural Building – a structure designed and constructed to house farm implements, hay, grain, poultry, livestock or other horticultural products; excluding any structure designed, constructed or used, in whole or in part, for human habitation, as a place of employment where agricultural products are processed, treated or packaged, or as a place used by the public.

Agricultural Property – the land for construction of a barn, *agricultural building*, silo, stockyard, pen or other structural practices identified in Table II in the “Agricultural Best Management Practice Systems Catalogue” (dated June 2023).

Alter Hydrology from Pre- to Post-Development Conditions – the post-development peak flow rate(s) has increased by more than 5% of the pre-developed condition for the design storm of interest (e.g. 10 yr and 100 yr).

Combined Sewer System – a sewer system which conveys sewage and *stormwater* through a single pipe system to a publicly owned treatment works.

Commence (Commencement of) Construction Activities – the initial disturbance of soils associated with clearing, grading or excavation activities; or other construction related activities that disturb or expose soils such as demolition, stockpiling of fill material, and the initial installation of erosion and sediment control practices required in the *SWPPP*. See definition for “*Construction Activity(ies)*” also.

Common Plan of Development or Sale – a contiguous area where multiple separate and distinct *construction activities* are occurring, or may occur, under one plan. The “common plan” of development or sale is broadly defined as any announcement or piece of documentation (including a sign, public notice or hearing, marketing plan, advertisement, drawing, permit application, State Environmental Quality Review Act (SEQR) environmental assessment form or other documents, zoning request, computer design, etc.) or physical demarcation (including boundary signs, lot stakes, surveyor markings, etc.) indicating *construction activities* may occur on a specific plot. A *common plan of development or sale* is comprised of two or more *phases*.

Common plan of development or sale does not include separate and distinct *construction activities* that are occurring, or may occur, under one plan that are at least 1/4 mile apart provided any interconnecting road, pipeline or utility project that is part of the same “common plan” is not concurrently being disturbed.

Construction Activity(ies) – identified within 40 CFR 122.26(b)(14)(x), 122.26(b)(15)(i), and 122.26(b)(15)(ii), any clearing, grading, excavation, filling, demolition or stockpiling activities that result in soil disturbance. Clearing activities can include, but are not limited to, mechanized logging equipment operation, the cutting and skidding of trees, stump removal and/or brush root removal.

Construction activity does not include routine maintenance that is performed to maintain the original line and grade, hydraulic capacity, or original purpose of a facility, which is excluded from the calculation of the soil disturbance for a project. Routine maintenance includes, but is not limited to:

- Re-grading of gravel roads or parking lots,
- Cleaning and shaping of existing roadside ditches and culverts that maintains the approximate original line and grade, and maintains or improves the hydraulic capacity of the ditch,
- Replacement of existing culverts that maintains the approximate original line and grade, and maintains or improves the hydraulic capacity of a ditch,
- Cleaning and shaping of existing roadside ditches that does not maintain the approximate original grade, hydraulic capacity and purpose of the ditch if the changes to the line and grade, hydraulic capacity or purpose of the ditch are installed to improve water quality and quantity controls (e.g. installing grass lined ditch),
- Placement of aggregate shoulder backing that stabilizes the transition between the road shoulder and the ditch or *embankment*,
- Full depth milling and filling of existing asphalt pavements, replacement of concrete pavement slabs, and similar work that does not expose soil or disturb the bottom six (6) inches of subbase material,
- Long-term use of equipment storage areas at or near highway maintenance facilities,
- Removal of sediment from the edge of the highway to restore a previously existing sheet-flow drainage connection from the highway surface to the highway ditch or *embankment*,
- Existing use of Canal Corp owned upland disposal sites for the canal, and
- Replacement of curbs, gutters, sidewalks and guide rail posts.
- Maintenance of ski trails including brush hog use and mowing
- Above ground snowmaking pipe replacement

Construction Site – the land area where *construction activity(ies)* will occur. See definition for “*Commence (Commencement of) Construction Activities*” and “*Larger Common Plan of Development or Sale*” also.

Dewatering – the act of draining rainwater and/or groundwater from building foundations, vaults or excavations/trenches.

Directly Discharge(s)(ing) (to a specific surface waterbody) – runoff flows from a *construction site* by overland flow and the first point of *discharge* is the specific surface waterbody, or runoff flows from a *construction site* to a separate storm sewer system and the first point of *discharge* from the separate storm sewer system is the specific surface waterbody.

Discharge(s)(d) – any addition of any *pollutant* to waters of the State through an outlet or *point source*.

Embankment – an earthen or rock slope that supports a road/highway.

Equivalent (Equivalence) – the practice or measure meets all the performance, longevity, maintenance, and safety objectives of the technical standard and will provide an equal or greater degree of water quality protection.

Final Stabilization – all soil disturbance activities have ceased and a uniform, perennial vegetative cover with a density of eighty (80) percent over the entire pervious surface has been established; or other *equivalent* stabilization measures, such as permanent landscape mulches, rock rip-rap or washed/crushed stone have been applied on all disturbed areas that are not covered by permanent structures, concrete or pavement.

Historic Property – any building, structure, site, object or district that is listed on the State or National Registers of Historic Places or is determined to be eligible for listing on the State or National Registers of Historic Places.

Impervious Area (Cover) – all impermeable surfaces that cannot effectively infiltrate rainfall. This includes paved, concrete and compacted gravel surfaces (i.e. parking lots, driveways, roads, runways and sidewalks); building rooftops and miscellaneous impermeable structures such as patios, pools, and sheds.

Infeasible – not technologically possible, or not economically practicable and achievable considering best industry practices.

Minimize(ing)(ation) – reduce and/or eliminate to the extent achievable using control measures (including best management practices) that are technologically available and economically practicable and achievable in light of best industry practices.

Municipal Separate Storm Sewer System (MS4) - a conveyance or system of conveyances (including roads with drainage systems, municipal streets, catch basins, curbs, gutters, ditches, man-made channels, or storm drains):

1. owned or operated by a State, city, town, village, borough, county, parish, district, association, or other public body (created by or pursuant to State law) having jurisdiction over disposal of sewage, industrial wastes, *stormwater*, or other wastes, including special districts under State law such

as a sewer district, flood control district or drainage district, or similar entity, or an Indian tribe or an authorized Indian tribal organization, or a designated and approved management agency under section 208 of the CWA, that *discharges to surface waters of the State*;

2. designed or used for collecting or conveying *stormwater*;
3. which is not a *combined sewer system*; and
4. which is not part of a Publicly Owned Treatment Works (POTW) as defined at 40 CFR 122.2.

Natural Buffer(s) – an undisturbed area with natural cover running along a surface water (e.g. wetland, stream, river, lake, etc.).

New Development – any land disturbance that does not meet the definition of *Redevelopment Activity* included in this appendix.

New York State Erosion and Sediment Control Certificate Program – a certificate program that establishes and maintains a process to identify and recognize individuals who are capable of developing, designing, inspecting and maintaining erosion and sediment control plans on projects that disturb soils in New York State. The certificate program is administered by the New York State Conservation District Employees Association.

Nonpoint Source(s) – any source of water pollution or *pollutants* which is not a discrete conveyance or *point source* permitted pursuant to Title 7 or 8 of Article 17 of the Environmental Conservation Law (see ECL Section 17-1403).

Overbank – flow events that exceed the capacity of the stream channel and spill out into the adjacent floodplain.

Owner or Operator – the person, persons, or legal entity which owns or leases the property on which the *construction activity* is occurring; an entity that has operational control over the construction plans and specifications, including the ability to make modifications to the plans and specifications; and/or an entity that has day-to-day operational control of those activities at a project that are necessary to ensure compliance with the permit requirements.

Performance Criteria – the six performance criteria for each group of SMPs in Chapters 5 and 6 of the technical standard, New York State Stormwater Management Design Manual (DM), dated July 31, 2024. These include feasibility, conveyance, pretreatment, treatment, landscaping, and maintenance. It does not include the *Sizing Criteria* (i.e. WQv, RRv, CPv, Qp and Qf) in Part I.C.2. of the permit.

Phase – a defined area in which *construction activities* are occurring or will occur separate from other defined area(s).

Point Source – any discernible, confined, and discrete conveyance, including but not limited to any pipe, ditch, channel, tunnel, conduit, well, discrete fissure, container, rolling stock, concentrated animal feeding operation, vessel or other floating craft, or landfill leachate collection system from which *pollutants* are or may be *discharged*.

Pollutant(s) – dredged spoil, filter backwash, solid waste, incinerator residue, sewage, garbage, sewage sludge, munitions, chemical wastes, biological materials, radioactive materials, heat, wrecked or discarded equipment, rock, sand and industrial, municipal, agricultural waste and ballast *discharged* into water; which may cause or might reasonably be expected to cause pollution of the waters of the state in contravention of the standards or guidance values adopted as provided in 6 NYCRR Parts 700 et seq.

Qualified Inspector – a person that is knowledgeable in the principles and practices of erosion and sediment control, such as a licensed Professional Engineer, Certified Professional in Erosion and Sediment Control (CPESC), Registered Landscape Architect, *New York State Erosion and Sediment Control Certificate Program* holder or other NYSDEC endorsed individual(s).

It can also mean someone working under the direct supervision of, and at the same company as, the licensed Professional Engineer or Registered Landscape Architect, provided that person has training in the principles and practices of erosion and sediment control. Training in the principles and practices of erosion and sediment control means that the individual working under the direct supervision of the licensed Professional Engineer or Registered Landscape Architect has received four (4) hours of NYSDEC endorsed training in proper erosion and sediment control principles from a Soil and Water Conservation District, or other NYSDEC endorsed entity. After receiving the initial training, the individual working under the direct supervision of the licensed Professional Engineer or Registered Landscape Architect shall receive four (4) hours of training every three (3) years.

It can also mean a person that meets the *Qualified Professional* qualifications in addition to the *Qualified Inspector* qualifications.

Note: Inspections of any SMPs that include structural components, such as a dam for an impoundment, shall be performed by a licensed Professional Engineer.

Qualified Professional – a person that is knowledgeable in the principles and practices of *stormwater* management and treatment, such as a licensed Professional Engineer, Registered Landscape Architect or other NYSDEC endorsed individual(s). Individuals preparing *SWPPPs* that require the SMP component must have an understanding of the principles of hydrology, water quality management practice design, water quantity control design, and, in many cases, the principles of hydraulics. All components of the

SWPPP that involve the practice of engineering, as defined by the NYS Education Law (see Article 145), shall be prepared by, or under the direct supervision of, a professional engineer licensed to practice in the State of New York.

Redevelopment Activity(ies) – the disturbance and reconstruction of existing *impervious area*, including *impervious areas* that were removed from a project site within five (5) years of preliminary project plan submission to the local government (i.e. site plan, subdivision, etc.).

Renewable Energy – electricity or thermal energy generated by renewable energy systems through use of the following technologies: solar thermal, photovoltaics, on land and offshore wind, hydroelectric, geothermal electric, geothermal ground source heat, tidal energy, wave energy, ocean thermal, and fuel cells which do not utilize a fossil fuel resource in the process of generating electricity.

Site Limitations – site conditions that prevent the use of an infiltration technique and or infiltration of the total WQv. Typical *site limitations* include: seasonal high groundwater, shallow depth to bedrock, and soils with an infiltration rate less than 0.5 inches/hour. The existence of *site limitations* shall be confirmed and documented using actual field testing (i.e. test pits, soil borings, and infiltration test) or using information from the most current United States Department of Agriculture (USDA) Soil Survey for the County where the project is located.

Sizing Criteria – the criteria included in Part I.C.2 of the permit that are used to size SMPs. The criteria include; Water Quality Volume (WQv), Runoff Reduction Volume (RRv), Channel Protection Volume (Cpv), *Overbank Flood* (Qp), and Extreme Flood (Qf).

Steep Slope – land area designated on the current United States Department of Agriculture (USDA) Soil Survey as Soil Slope Phase D, (provided the map unit name or description is inclusive of slopes greater than 25%), or Soil Slope Phase E or F, (regardless of the map unit name), or a combination of the three designations.

Stormwater – that portion of precipitation that, once having fallen to the ground, is in excess of the evaporative or infiltrative capacity of soils, or the retentive capacity of surface features, which flows or will flow off the land by surface runoff to waters of the State.

Streambank – the terrain alongside the bed of a creek or stream. The bank consists of the sides of the channel, between which the flow is confined.

Stormwater Pollution Prevention Plan (SWPPP) – a project specific report, including construction drawings, that among other things: describes the *construction activity(ies)*, identifies the potential sources of pollution at the *construction site*; describes and shows the *stormwater* controls that will be used to control the *pollutants* (i.e. erosion and

sediment controls; for many projects, includes SMPs); and identifies procedures the *owner or operator* will implement to comply with the requirements of the permit. See Part III of the permit for a complete description of the information that must be included in the *SWPPP*.

Surface Waters of the State – shall be construed to include lakes, bays, sounds, ponds, impounding reservoirs, springs, rivers, streams, creeks, estuaries, marshes, inlets, canals, the Atlantic ocean within the territorial seas of the state of New York and all other bodies of surface water, natural or artificial, inland or coastal, fresh or salt, public or private (except those private waters that do not combine or effect a junction with natural surface waters), which are wholly or partially within or bordering the state or within its jurisdiction. Waters of the state are further defined in 6 NYCRR Parts 800 to 941.

Temporarily Ceased – an existing disturbed area will not be disturbed again within 14 calendar days of the previous soil disturbance.

Temporary Stabilization – exposed soil has been covered with material(s) as set forth in the technical standard, New York Standards and Specifications for Erosion and Sediment Control, to prevent the exposed soil from eroding. The materials can include, but are not limited to, mulch, seed and mulch, and erosion control mats (e.g. jute twisted yarn, excelsior wood fiber mats).

Total Maximum Daily Load (TMDL) – the sum of the allowable loads of a single *pollutant* from all contributing point and *nonpoint sources*. It is a calculation of the maximum amount of a *pollutant* that a waterbody can receive and still meet *water quality standards*, and an allocation of that amount to the *pollutant's* sources. A TMDL stipulates Waste Load Allocations (WLA) for *point source discharges*, Load Allocations (LA) for *nonpoint sources*, and a margin of safety (MOS).

Traditional Land Use Control MS4 Operator – a city, town, or village with land use control authority that is authorized to *discharge* under New York State DEC's SPDES General Permit For Stormwater Discharges from Municipal Separate Stormwater Sewer Systems (MS4s) or the City of New York's Individual SPDES Permit for their Municipal Separate Storm Sewer Systems (NY-0287890).

Trained Contractor – an employee from the contracting (construction) company, identified in Part III.A.7., that has received four (4) hours of NYSDEC endorsed training in proper erosion and sediment control principles from a Soil and Water Conservation District, or other NYSDEC endorsed entity. After receiving the initial training, the *trained contractor* shall receive four (4) hours of training every three (3) years.

It can also mean an employee from the contracting (construction) company, identified in Part III.A.7., that meets the *qualified inspector* qualifications (e.g. licensed Professional Engineer, Certified Professional in Erosion and Sediment Control (CPESC), Registered

Landscape Architect, *New York State Erosion and Sediment Control Certificate Program* holder, or someone working under the direct supervision of, and at the same company as, the licensed Professional Engineer or Registered Landscape Architect, provided they have received four (4) hours of NYSDEC endorsed training in proper erosion and sediment control principles from a Soil and Water Conservation District, or other NYSDEC endorsed entity).

The *trained contractor* is responsible for the day-to-day implementation of the *SWPPP*.

Tree Clearing – *construction activities* limited to felling and removal of trees.

Tree clearing does not include hand felling and leaving the trees in place with no support from mechanized equipment, which is not considered *construction activity* requiring coverage under this permit.

Water Quality Standard – such measures of purity or quality for any waters in relation to their reasonable and necessary use as promulgated in 6 NYCRR Part 700 et seq.

DRAFT

APPENDIX B – Required SWPPP Components by Project Type

Table 1

CONSTRUCTION ACTIVITIES THAT REQUIRE THE PREPARATION OF A SWPPP THAT ONLY INCLUDES EROSION AND SEDIMENT CONTROLS

<p>The following <i>construction activities</i> that involve soil disturbances of one (1) or more acres of land, but less than five (5) acres:</p> <ul style="list-style-type: none">• Single-family home <u>not</u> located in one of the watersheds listed in Appendix C and <u>not directly discharging</u> to one of the 303(d) segments listed in Appendix D• Single-family residential subdivisions with 25% or less <i>impervious cover</i> at total site build-out and <u>not</u> located in one of the watersheds listed in Appendix C and <u>not directly discharging</u> to one of the 303(d) segments listed in Appendix D• Construction of a barn or other <i>agricultural building</i>, silo, stock yard or pen.
<p>The following <i>construction activities</i> that involve soil disturbances between five thousand (5000) square feet and one (1) acre of land:</p> <p>All <i>construction activities</i> located in the New York City Watershed located east of the Hudson River, see Appendix C Figure 1, that involve soil disturbances between five thousand (5,000) square feet and one (1) acre of land.</p>
<p>All other <i>construction activities</i>:</p> <ul style="list-style-type: none">• Installation of underground linear utilities; such as gas lines, fiber-optic cable, cable TV, electric, telephone, sewer mains, and water mains• Environmental enhancement projects, such as wetland mitigation, <i>stormwater</i> retrofits, and stream restoration• Pond construction• Linear bike paths running through areas with vegetative cover, including bike paths surfaced with an <i>impervious cover</i>• Cross-country ski trails and walking/hiking trails• Dam rehabilitation (the structure of the dam itself)• Sidewalks, bike paths, or walking paths, surfaced with an <i>impervious cover</i>, that are not part of residential, commercial, or institutional development;• Sidewalks, bike paths, or walking paths, surfaced with an <i>impervious cover</i>, that include incidental shoulder or curb work along an existing highway to support construction of the sidewalk, bike path, or walking path.• Golf cart path construction or reconstruction, surfaced with an <i>impervious cover</i>, at an existing golf course.

Table 1 (Continued)
CONSTRUCTION ACTIVITIES THAT REQUIRE THE PREPARATION OF A SWPPP
THAT ONLY INCLUDES EROSION AND SEDIMENT CONTROLS

All other construction activities:

- Slope stabilization
- Slope flattening that changes the grade of the site, but does not significantly change the runoff characteristics
- Spoil areas that will be covered with vegetation
- Vegetated open space (i.e. recreational parks, lawns, meadows, fields, downhill ski trails) that do not *alter hydrology from pre- to post-development* conditions
- Athletic fields (natural grass) that do not include the construction or reconstruction of *impervious area* and do not *alter hydrology from pre- to post-development* conditions
- Demolition where vegetation will be established, and no *redevelopment activity* is planned¹
- Overhead electric transmission line and ski lift tower installation or replacement that does not include the construction of permanent access roads or parking areas surfaced with *impervious cover*
- Solar array field areas that have tables elevated off the ground, spaced one table width apart, do not *alter hydrology from pre- to post-development conditions*, and address water quality volume and runoff reduction volume by maintaining sheet flow on slopes less than 8%.
- Structural agricultural conservation practices as identified in Table II in the “Agricultural Best Management Practice Systems Catalogue” (dated June 2023), excluding those that involve soil disturbances of greater than five acres that include construction or reconstruction of *impervious area* or *alter hydrology from pre- to post-development* conditions.
- Temporary access roads, median crossovers, detour roads, lanes, or other temporary *impervious areas* that will be restored to pre-construction conditions once the *construction activity* is complete (in this context, “temporary” means the *impervious area* will be in place for one year or less)
- Other *construction activities* that do not include the construction or reconstruction of *impervious area*, and do not *alter hydrology from pre- to post-development* conditions, and are not listed in Table 2.

1. If the site is redeveloped in the future, a new eNOI must be submitted.

Table 2
CONSTRUCTION ACTIVITIES THAT REQUIRE THE PREPARATION OF A SWPPP THAT INCLUDES
POST-CONSTRUCTION STORMWATER MANAGEMENT PRACTICES (SMPs)

The following construction activities:

- Single-family home located in one of the watersheds listed in Appendix C or *directly discharging* to one of the 303(d) segments listed in Appendix D
- Single-family home that disturbs five (5) or more acres of land
- Single-family residential subdivisions located in one of the watersheds listed in Appendix C or *directly discharging* to one of the 303(d) segments listed in Appendix D
- Single-family residential subdivisions that involve soil disturbances of between one (1) and five (5) acres of land with greater than 25% *impervious cover* at total site build-out
- Single-family residential subdivisions that involve soil disturbances of between 20,000 square feet and one (1) acre of land within the municipal boundaries of NYC with greater than 25% *impervious cover* at total site build-out
- Single-family residential subdivisions that involve soil disturbances of five (5) or more acres of land, and single-family residential subdivisions that involve soil disturbances of less than five (5) acres that are part of a *common plan of development or sale* that will ultimately disturb five (5) or more acres of land
- Multi-family residential developments; includes duplexes, townhomes, condominiums, senior housing complexes, apartment complexes, and mobile home parks (in this context, a multi-family residence will be one that meets the definition of a “multi-family residence” or the equivalent in the local building code)
- Creation of 5,000 square feet or more of *impervious area* in the municipal boundaries of NYC
- Airports
- Amusement parks
- Breweries, cideries, and wineries, including establishments constructed on agricultural land
- Campgrounds
- Cemeteries that include the construction or reconstruction of *impervious area* (>5% of disturbed area) or *alter the hydrology from pre- to post-development* conditions
- Commercial developments
- Churches and other places of worship
- Construction of a barn or other *agricultural building* (e.g. silo) that involves soil disturbance greater than five acres.
- Structural agricultural conservation practices as identified in Table II in the “Agricultural Best Management Practice Systems Catalogue” (dated June 2023) that involves soil disturbance greater than five acres and include the construction or reconstruction of *impervious area* or *alter hydrology from pre- to post-development* conditions.
- Facility buildings, including ski lodges, restroom buildings, pumphouses, ski lift terminals, and maintenance and groomer garages
- Institutional development; includes hospitals, prisons, schools and colleges
- Industrial facilities; includes industrial parks
- Landfills; including creation of landfills or capping landfills.
- Municipal facilities; includes highway garages, transfer stations, office buildings, POTWs, water treatment plants, and water storage tanks
- New golf courses
- Office complexes

Table 2 (Continued)

CONSTRUCTION ACTIVITIES THAT REQUIRE THE PREPARATION OF A SWPPP THAT INCLUDES POST-CONSTRUCTION STORMWATER MANAGEMENT PRACTICES (SMPs)

The following *construction activities*:

- Permanent laydown yards and equipment storage lots
- Playgrounds that include the construction or reconstruction of *impervious area*
- Sports complexes
- Racetracks; includes racetracks with earthen (dirt) surfaces
- Road construction or reconstruction, including roads constructed as part of the *construction activities* listed in Table 1
- Parking lot construction or reconstruction, including parking lots constructed as part of the *construction activities* listed in Table 1
- Athletic fields (natural grass) that include the construction or reconstruction of *impervious area* (>5% of disturbed area) or *alter the hydrology from pre- to post-development* conditions
- Athletic fields with artificial turf
- Permanent access roads, parking areas, substations, compressor stations, and well drilling pads, surfaced with *impervious cover*, and constructed as part of an overhead electric transmission line, wind-power, cell tower, oil or gas well drilling, sewer or water main, ski lift, or other linear utility project
- Sidewalks, bike paths, or walking paths, surfaced with an *impervious cover*, that are part of a residential, commercial or institutional development
- Sidewalks, bike paths, or walking paths, surfaced with an *impervious cover*, that are part of highway construction or reconstruction
- Solar array field areas on slopes greater than 8% that cannot maintain sheet flow using management practices identified in the BB or the DM
- Solar array field areas on slopes less than 8% that will *alter the hydrology from pre- to post-development* conditions
- Solar array field areas with ground-mounted tables
- Traditional *impervious areas* associated with solar development (e.g. roads, buildings, transformers)
- Utility pads surfaced with *impervious cover*, including electric vehicle charging stations
- All other *construction activities* that include the construction or reconstruction of *impervious area* or *alter the hydrology from pre- to post-development* conditions, and are not listed in Table 1

APPENDIX C – Watersheds Requiring Enhanced Phosphorus Removal

Watersheds where *owners or operators of construction activities* identified in Table 2 of Appendix B must prepare a *SWPPP* that includes *SMPs* designed in conformance with the Enhanced Phosphorus Removal Standards included in the DM technical standard.

- Entire New York City Watershed located east of the Hudson River – Figure 1
- Onondaga Lake Watershed – Figure 2
- Greenwood Lake Watershed – Figure 3
- Oscawana Lake Watershed – Figure 4
- Kinderhook Lake Watershed – Figure 5

Figure 1 - New York City Watershed East of the Hudson

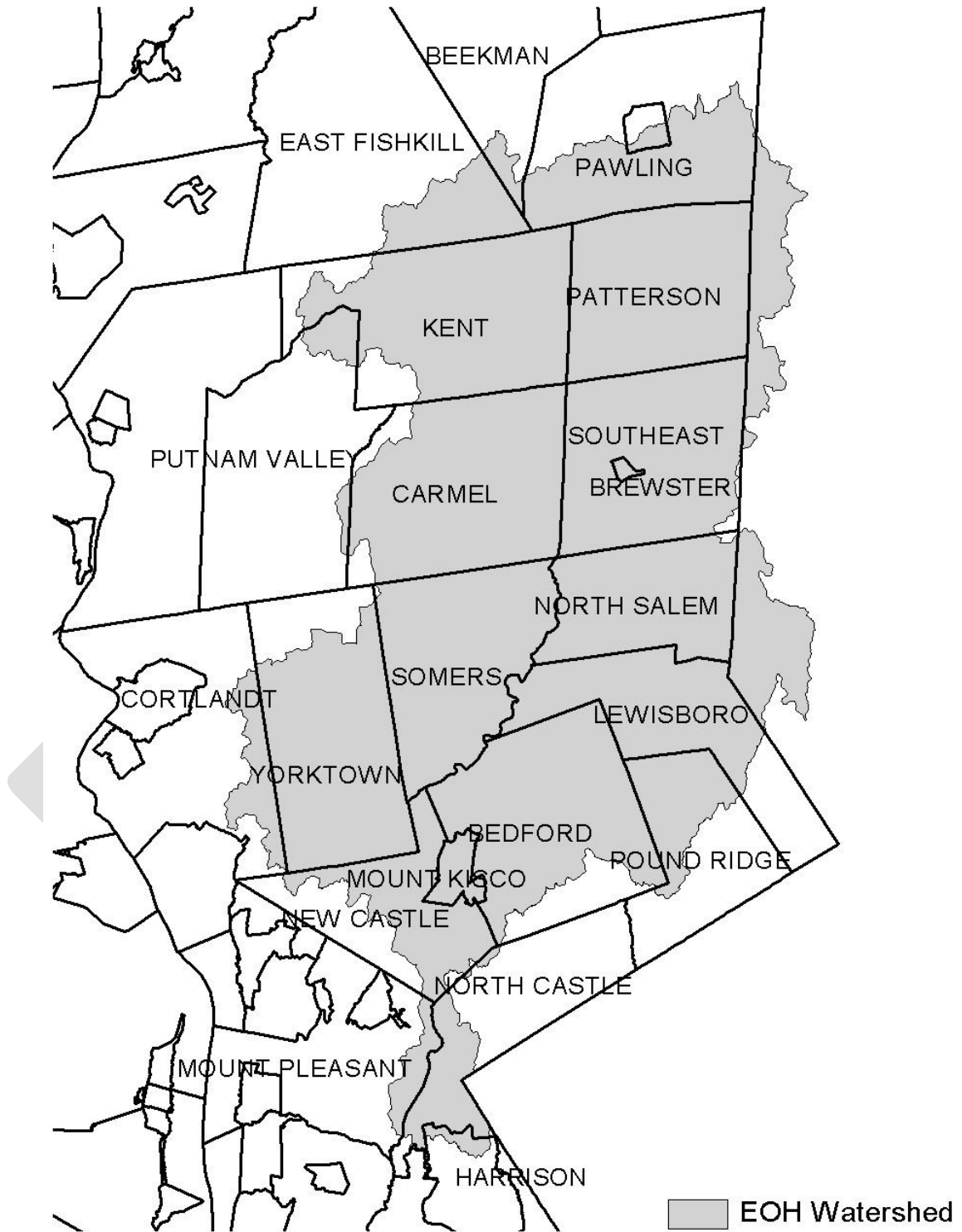

Figure 2 - Onondaga Lake Watershed



Figure 3 - Greenwood Lake Watershed

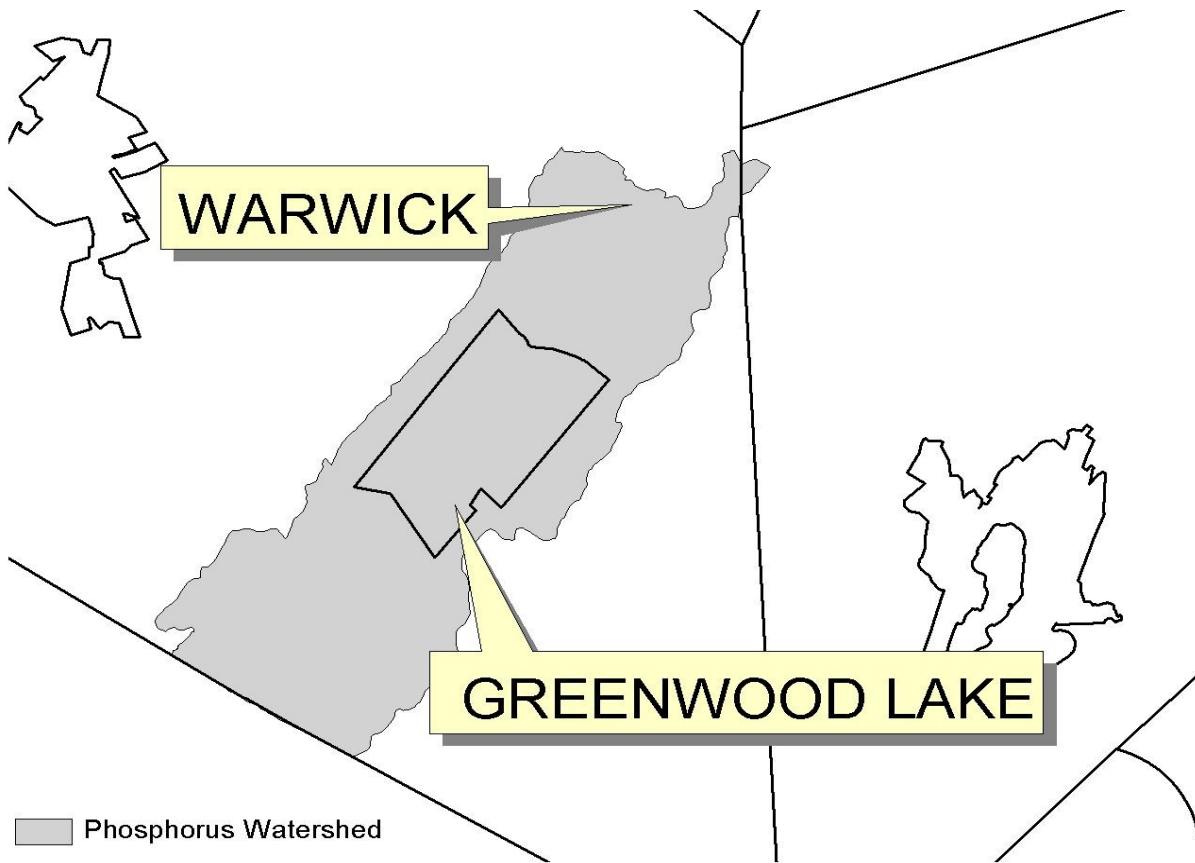

Figure 4 - Oscawana Lake Watershed

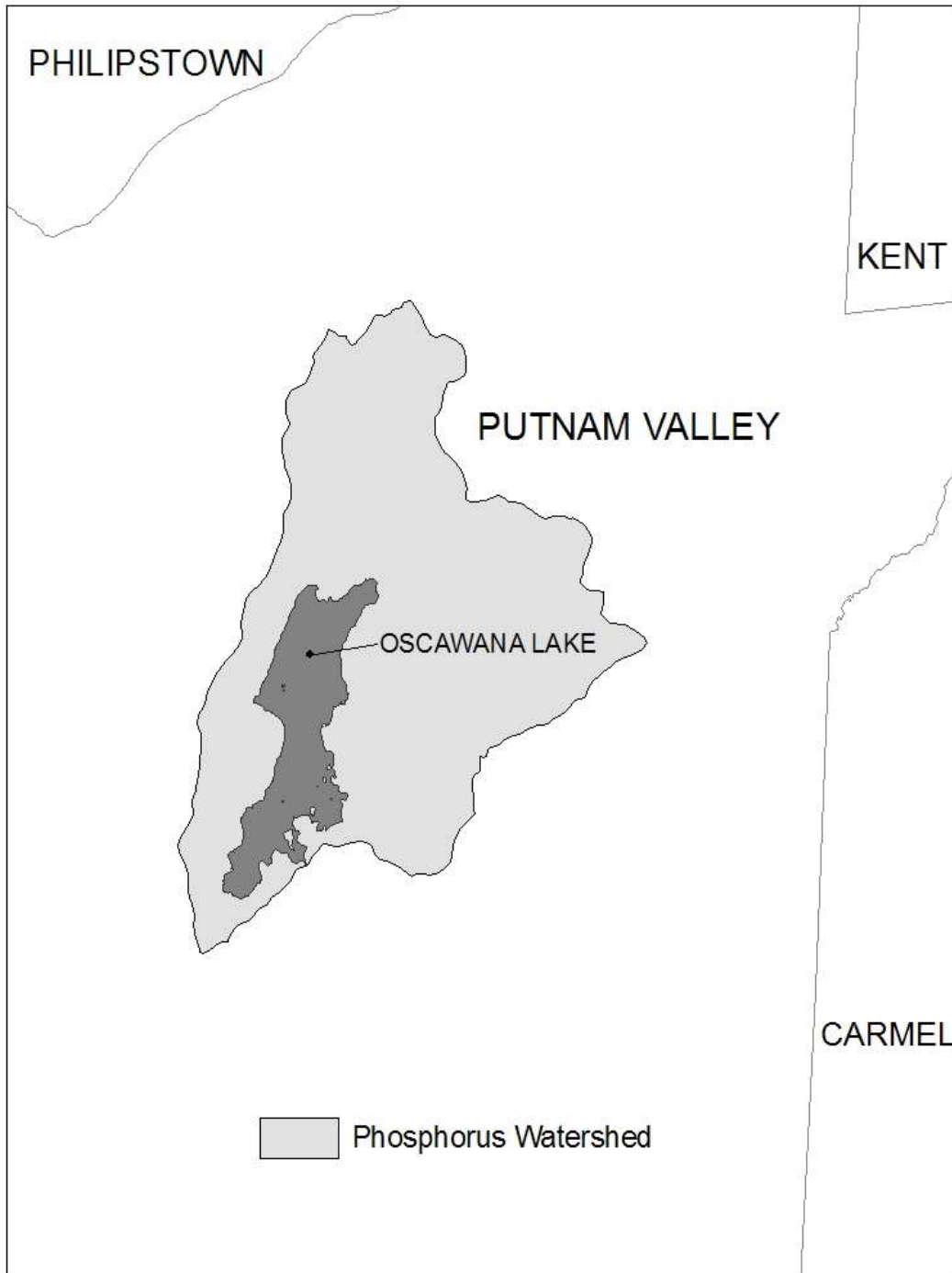
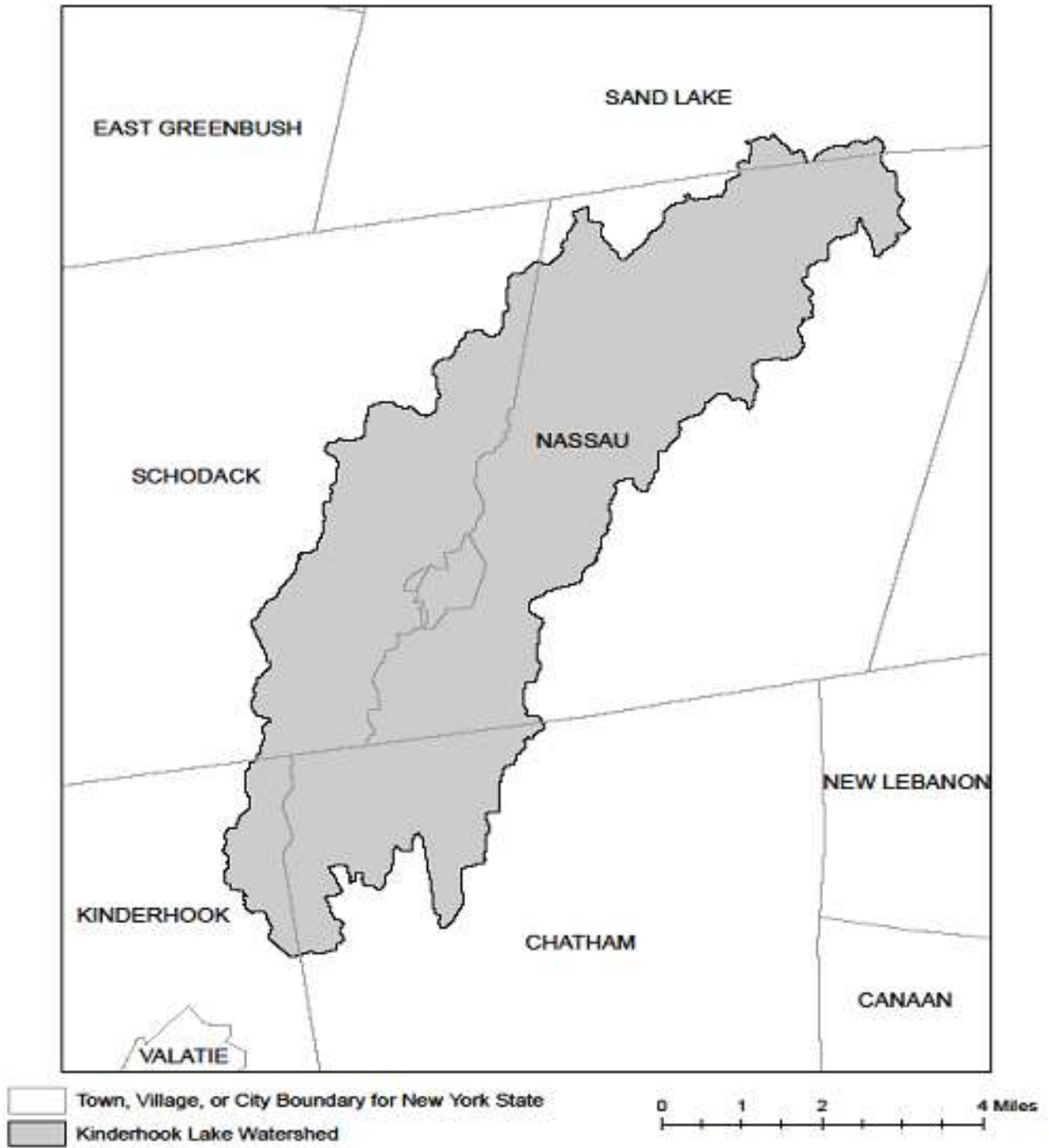

Figure 5 - Kinderhook Lake Watershed



APPENDIX D – Impaired Waterbodies (by Construction Related Pollutants)

List of waterbodies impaired by *pollutants* related to *construction activity*, including turbidity, silt/sediment, and nutrients (e.g. nitrogen, phosphorus). This list is a subset of “The Final New York State 2018 Section 303(d) List of Impaired Waters Requiring a TMDL” dated June 2020.

County	Waterbody	Pollutant
Albany	Ann Lee (Shakers) Pond, Stump Pond (1201-0096)	Phosphorus
Albany	Lawsons Lake (1301-0235)	Phosphorus
Allegany	Amity Lake, Saunders Pond (0403-0054)	Phosphorus
Allegany	Andover Pond (0403-0056)	Phosphorus
Bronx	Reservoir No.1/Lake Isle (1702-0075)	Phosphorus
Bronx	Van Cortlandt Lake (1702-0008)	Phosphorus
Broome	Blueberry, Laurel Lakes (1404-0033)	Phosphorus
Broome	Fly Pond, Deer Lake (1404-0038)	Phosphorus
Broome	Minor Tribs to Lower Susquehanna (0603-0044)	Phosphorus
Broome	Whitney Point Lake/Reservoir (0602-0004)	Phosphorus
Cattaraugus	Allegheny River/Reservoir (0201-0023)	Phosphorus
Cattaraugus	Beaver Lake/Alma Pond (0201-0073)	Phosphorus
Cattaraugus	Case Lake (0201-0020)	Phosphorus
Cattaraugus	Linlyco/Club Pond (0201-0035)	Phosphorus
Cayuga	Duck Lake (0704-0025)	Phosphorus
Cayuga	Owasco Inlet, Upper, and tribs (0706-0014)	Nutrients
Chautauqua	Chadakoin River and tribs (0202-0018)	Phosphorus
Chautauqua	Hulburt/Clymer Pond (0202-0079)	Phosphorus
Chautauqua	Middle Cassadaga Lake (0202-0002)	Phosphorus
Clinton	Great Chazy River, Lower, Main Stem (1002-0001)	Silt/Sediment
Columbia	Robinson Pond (1308-0003)	Phosphorus
Cortland	Dean Pond (0602-0077)	Phosphorus
Dutchess	Fallkill Creek (1301-0087)	Phosphorus
Dutchess	Hillside Lake (1304-0001)	Phosphorus
Dutchess	Wappingers Lake (1305-0001)	Phosphorus
Dutchess	Wappingers Lake (1305-0001)	Silt/Sediment
Erie	Beeman Creek and tribs (0102-0030)	Phosphorus
Erie	Delaware Park Pond (0101-0026)	Phosphorus
Erie	Ellicott Creek, Lower, and tribs (0102-0018)	Phosphorus
Erie	Ellicott Creek, Lower, and tribs (0102-0018)	Silt/Sediment
Erie	Green Lake (0101-0038)	Phosphorus
Erie	Little Sister Creek, Lower, and tribs (0104-0045)	Phosphorus
Erie	Murder Creek, Lower, and tribs (0102-0031)	Phosphorus
Erie	Rush Creek and tribs (0104-0018)	Phosphorus

Erie	Scajaquada Creek, Lower, and tribs (0101-0023)	Phosphorus
Erie	Scajaquada Creek, Middle, and tribs (0101-0033)	Phosphorus
Erie	Scajaquada Creek, Upper, and tribs (0101-0034)	Phosphorus
Erie	South Branch Smoke Cr, Lower, and tribs (0101-0036)	Phosphorus
Erie	South Branch Smoke Cr, Lower, and tribs (0101-0036)	Silt/Sediment
Genesee	Bigelow Creek and tribs (0402-0016)	Phosphorus
Genesee	Black Creek, Middle, and minor tribs (0402 0028)	Phosphorus
Genesee	Black Creek, Upper, and minor tribs (0402-0048)	Phosphorus
Genesee	Bowen Brook and tribs (0102-0036)	Phosphorus
Genesee	LeRoy Reservoir (0402-0003)	Phosphorus
Genesee	Mill Pond (0402-0050)	Phosphorus
Genesee	Oak Orchard Cr, Upper, and tribs (0301-0014)	Phosphorus
Genesee	Oatka Creek, Middle, and minor tribs (0402-0031)	Phosphorus
Genesee	Tonawanda Cr, Middle, Main Stem (0102-0002)	Phosphorus
Greene	Schoharie Reservoir (1202-0012)	Silt/Sediment
Greene	Sleepy Hollow Lake (1301-0059)	Silt/Sediment
Herkimer	Steele Creek tribs (1201-0197)	Phosphorus
Herkimer	Steele Creek tribs (1201-0197)	Silt/Sediment
Kings	Hendrix Creek (1701-0006) 18	Nitrogen
Kings	Prospect Park Lake (1701-0196)	Phosphorus
Lewis	Mill Creek/South Branch, and tribs (0801-0200)	Nutrients
Livingston	Christie Creek and tribs (0402-0060)	Phosphorus
Livingston	Conesus Lake (0402-0004)	Phosphorus
Livingston	Mill Creek and minor tribs (0404-0011)	Silt/Sediment
Monroe	Black Creek, Lower, and minor tribs (0402-0033)	Phosphorus
Monroe	Buck Pond (0301-0017)	Phosphorus
Monroe	Cranberry Pond (0301-0016)	Phosphorus
Monroe	Durand, Eastman Lakes (0302-0037)	Phosphorus
Monroe	Lake Ontario Shoreline, Western (0301-0069) 9	Phosphorus
Monroe	Long Pond (0301-0015)	Phosphorus
Monroe	Mill Creek and tribs (0302-0025)	Phosphorus 2
Monroe	Mill Creek/Blue Pond Outlet and tribs (0402-0049)	Phosphorus
Monroe	Minor Tribs to Irondequoit Bay (0302-0038)	Phosphorus
Monroe	Rochester Embayment - East (0302-0002) [9]	Phosphorus
Monroe	Rochester Embayment - West (0301-0068) 9	Phosphorus
Monroe	Shipbuilders Creek and tribs (0302-0026)	Phosphorus 2
Monroe	Thomas Creek/White Brook and tribs (0302-0023)	Phosphorus
Nassau	Bannister Creek/Bay (1701-0380)	Nitrogen

Nassau	Beaver Lake (1702-0152)	Phosphorus
Nassau	Browswere Bay (1701-0383)	Nitrogen
Nassau	Camaans Pond (1701-0052)	Phosphorus
Nassau	East Meadow Brook, Upper, and tribs (1701-0211)	Silt/Sediment
Nassau	East Rockaway Channel (1701-0381)	Nitrogen
Nassau	Glen Cove Creek, Lower, and tribs (1702-0146)	Silt/Sediment
Nassau	Grant Park Pond (1701-0054)	Phosphorus
Nassau	Hempstead Bay, Broad Channel (1701-0032)	Nitrogen
Nassau	Hempstead Lake (1701-0015)	Phosphorus
Nassau	Hewlett Bay (1701-0382)	Nitrogen
Nassau	Hog Island Channel (1701-0220)	Nitrogen
Nassau	Massapequa Creek, Upper, and tribs (1701-0174)	Phosphorus
Nassau	Milburn/Parsonage Creeks, Upp, and tribs (1701-0212)	Phosphorus
Nassau	Reynolds Channel, East (1701-0215) [12]	Nitrogen
Nassau	Reynolds Channel, West (1701-0216) 12	Nitrogen
Nassau	Tidal Tribs to Hempstead Bay (1701-0218)	Nitrogen
Nassau	Tribs (fresh) to East Bay (1701-0204)	Silt/Sediment
Nassau	Tribs (fresh) to East Bay (1701-0204)	Phosphorus
Nassau	Tribs to Smith Pond/Halls Pond (1701-0221)	Phosphorus
Nassau	Woodmere Channel (1701-0219)	Nitrogen
New York	Harlem Meer (1702-0103)	Phosphorus
New York	The Lake in Central Park (1702-0105)	Phosphorus
Niagara	Bergholtz Creek and tribs (0101-0004)	Phosphorus
Niagara	Hyde Park Lake (0101-0030)	Phosphorus
Niagara	Lake Ontario Shoreline, Western (0301-0053) 9	Phosphorus
Niagara	Lake Ontario Shoreline, Western (0301-0072) 9	Phosphorus
Oneida	Ballou, Nail Creeks (1201-0203)	Phosphorus
Onondaga	Ley Creek and tribs (0702-0001) 10	Nutrients (phosphorus)
Onondaga	Minor Tribs to Onondaga Lake (0702-0022) 10	Nutrients (phosphorus)
Onondaga	Minor Tribs to Onondaga Lake (0702-0022) 10	Nitrogen (NH ₃ , NO ₂)
Onondaga	Onondaga Creek, Lower (0702-0023) 10	Nutrients (phosphorus)
Onondaga	Onondaga Creek, Lower, and tribs (0702-0023)	Turbidity
Onondaga	Onondaga Creek, Middle, and tribs (0702-0004)	Turbidity
Onondaga	Onondaga Creek, Upper, and tribs (0702-0024)	Turbidity
Ontario	Great Brook and minor tribs (0704-0034)	Phosphorus 2
Ontario	Great Brook and minor tribs (0704-0034)	Silt/Sediment
Ontario	Hemlock Lake Outlet and minor tribs (0402-0013)	Phosphorus

Ontario	Honeoye Lake (0402-0032)	Phosphorus
Orange	Brown Pond Reservoir (1303-0013)	Phosphorus
Orange	Lake Washington (1303-0012)	Phosphorus
Orange	Minor Tribs to Middle Wallkill (1306-0061)	Phosphorus
Orange	Monhagen Brook and tribs (1306-0074)	Phosphorus
Orange	Orange Lake (1301-0008) [16]	Phosphorus
Orange	Quaker Creek and tribs (1306-0025)	Phosphorus
Orange	Wallkill River, Middle, Main Stem (1306-0038)	Phosphorus
Orange	Wallkill River, Upper, and Minor tribs (1306-0017)	Phosphorus
Orleans	Glenwood Lake (0301-0041)	Phosphorus
Orleans	Lake Ontario Shoreline, Western (0301-0070) 9	Phosphorus
Orleans	Lake Ontario Shoreline, Western (0301-0071) 9	Phosphorus
Oswego	Lake Neatahwanta (0701-0018)	Nutrients (phosphorus)
Oswego	Pleasant Lake (0703-0047)	Phosphorus
Putnam	Lost Lake, Putnam Lake (1302-0053)	Phosphorus
Putnam	Minor Tribs to Croton Falls Reservoir (1302-0001)	Phosphorus
Queens	Bergen Basin (1701-0009) 18	Nitrogen
Queens	Jamaica Bay, Eastern, and tribs, Queens (1701-0005) 18	Nitrogen
Queens	Kissena Lake (1702-0258)	Phosphorus
Queens	Meadow Lake (1702-0030)	Phosphorus
Queens	Shellbank Basin (1701-0001) 18	Nitrogen
Queens	Willow Lake (1702-0031)	Phosphorus
Rensselaer	Nassau Lake (1310-0001)	Phosphorus
Rensselaer	Snyders Lake (1301-0043)	Phosphorus
Richmond	Grassmere Lake/Bradys Pond (1701-0357)	Phosphorus
Rockland	Congers Lake, Swartout Lake (1501-0019)	Phosphorus
Rockland	Rockland Lake (1501-0021)	Phosphorus
Saratoga	Ballston Lake (1101-0036)	Phosphorus
Saratoga	Dwaas Kill and tribs (1101-0007)	Phosphorus
Saratoga	Dwaas Kill and tribs (1101-0007)	Silt/Sediment
Saratoga	Lake Lonely (1101-0034)	Phosphorus
Saratoga	Round Lake (1101-0060)	Phosphorus
Saratoga	Tribs to Lake Lonely (1101-0001)	Phosphorus
Schenectady	Collins Lake (1201-0077)	Phosphorus
Schenectady	Duane Lake (1311-0006)	Phosphorus
Schenectady Lake	Mariaville Lake (1201-0113)	Phosphorus
Schuyler	Cayuta Lake (0603-0005)	Phosphorus
Seneca	Reeder Creek and tribs (0705-0074)	Phosphorus

St.Lawrence	Black Lake Outlet, Black Lake (0906-0001)	Phosphorus
St.Lawrence	Fish Creek and minor tribs (0906-0026)	Phosphorus
Steuben	Smith Pond (0502-0012)	Phosphorus
Suffolk	Agawam Lake (1701-0117)	Phosphorus
Suffolk	Big/Little Fresh Ponds (1701-0125)	Phosphorus
Suffolk	Canaan Lake (1701-0018)	Phosphorus
Suffolk	Canaan Lake (1701-0018)	Silt/Sediment
Suffolk	Fresh Pond (1701-0241)	Phosphorus
Suffolk	Great South Bay, East (1701-0039)	Nitrogen
Suffolk	Great South Bay, Middle (1701-0040)	Nitrogen
Suffolk	Great South Bay, West (1701-0173)	Nitrogen
Suffolk	Lake Ronkonkoma (1701-0020)	Phosphorus
Suffolk	Mattituck/Marratooka Pond (1701-0129)	Phosphorus
Suffolk	Mill and Seven Ponds (1701-0113)	Phosphorus
Suffolk	Millers Pond (1702-0013)	Phosphorus
Suffolk	Moriches Bay, East (1701-0305)	Nitrogen
Suffolk	Moriches Bay, West (1701-0038)	Nitrogen
Suffolk	Quantuck Bay (1701-0042)	Nitrogen
Suffolk	Shinnecock Bay and Inlet (1701-0033)	Nitrogen
Suffolk	Tidal Tribs to West Moriches Bay (1701-0312)	Nitrogen
Sullivan	Bodine, Montgomery Lakes (1401-0091)	Phosphorus
Sullivan	Davies Lake (1402-0047)	Phosphorus
Sullivan	Evens Lake (1402-0004)	Phosphorus
Sullivan	Pleasure Lake (1402-0055)	Phosphorus
Sullivan	Swan Lake (1401-0063)	Phosphorus
Tompkins	Cayuga Lake, Southern End (0705-0040)	Phosphorus
Tompkins	Cayuga Lake, Southern End (0705-0040)	Silt/Sediment
Ulster	Ashokan Reservoir (1307-0004)	Silt/Sediment
Ulster	Esopus Creek, Lower, Main Stem (1307-0010) [17]	Turbidity
Ulster	Esopus Creek, Middle, Main Stem (1307-0003) 17	Turbidity
Ulster	Esopus Creek, Upper, and minor tribs (1307-0007)[3]	Silt/Sediment
Ulster	Wallkill River, Lower, Main Stem (1306-0027)	Phosphorus
Warren	Hague Brook and tribs (1006-0006)	Silt/Sediment
Warren	Huddle/Finkle Brooks and tribs (1006-0003)	Silt/Sediment
Warren	Indian Brook and tribs (1006-0002)	Silt/Sediment
Warren	Lake George (1006-0016) and tribs	Silt/Sediment
Warren	Tribs to Lake George, East Shore (1006-0020)	Silt/Sediment
Warren	Tribs to Lake George, Lk.George Village (1006-0008)	Silt/Sediment
Washington	Wood Cr/Champlain Canal and tribs (1005-0036)	Phosphorus

Westchester	Lake Katonah (1302-0136)	Phosphorus
Westchester	Lake Lincolndale (1302-0089)	Phosphorus
Westchester	Lake Meahagh (1301-0053)	Phosphorus
Westchester	Lake Mohegan (1301-0149)	Phosphorus
Westchester	Lake Shenorock (1302-0083)	Phosphorus
Westchester	Mamaroneck River, Lower (1702-0071)	Silt/Sediment
Westchester	Mamaroneck River, Upp, & minor tribs (1702-0123)	Silt/Sediment
Westchester	Saw Mill River (1301-0007)	Phosphorus
Westchester	Saw Mill River, Middle, and tribs (1301-0100)	Phosphorus
Westchester	Sheldrake River (1702-0069)	Phosphorus
Westchester	Sheldrake River (1702-0069)	Silt/Sedimnt
Westchester	Silver Lake (1702-0040)	Phosphorus
Westchester	Teatown Lake (1302-0150)	Phosphorus
Westchester	Truesdale Lake (1302-0054)	Phosphorus
Westchester	Wallace Pond (1301-0140)	Phosphorus

APPENDIX E – List of NYSDEC Regional Offices

<u>Region</u>	<u>COVERING THE FOLLOWING COUNTIES:</u>	<u>DIVISION OF ENVIRONMENTAL PERMITS (DEP) PERMIT ADMINISTRATORS</u>	<u>DIVISION OF WATER (DOW) WATER (SPDES) PROGRAM</u>
1	NASSAU AND SUFFOLK	50 CIRCLE ROAD STONY BROOK, NY 11790 TEL. (631) 444-0365	50 CIRCLE ROAD STONY BROOK, NY 11790-3409 TEL. (631) 444-0405
2	BRONX, KINGS, NEW YORK, QUEENS AND RICHMOND	1 HUNTERS POINT PLAZA, 47-40 21ST ST. LONG ISLAND CITY, NY 11101-5407 TEL. (718) 482-4997	1 HUNTERS POINT PLAZA, 47-40 21ST ST. LONG ISLAND CITY, NY 11101-5407 TEL. (718) 482-4933
3	DUTCHESS, ORANGE, PUTNAM, ROCKLAND, SULLIVAN, ULSTER AND WESTCHESTER	21 SOUTH PUTT CORNERS ROAD NEW PALTZ, NY 12561-1696 TEL. (845) 256-3059	220 WHITE PLAINS ROAD, SUITE 110 TEL. (914) 428 - 2505
4	ALBANY, COLUMBIA, DELAWARE, GREENE, MONTGOMERY, OTSEGO, RENSSELAER, SCHENECTADY AND SCHOHARIE	1130 NORTH WESTCOTT ROAD SCHENECTADY, NY 12306-2014 TEL. (518) 357-2069	1130 NORTH WESTCOTT ROAD SCHENECTADY, NY 12306-2014 TEL. (518) 357-2045
5	CLINTON, ESSEX, FRANKLIN, FULTON, HAMILTON, SARATOGA, WARREN AND WASHINGTON	1115 STATE ROUTE 86, Po Box 296 RAY BROOK, NY 12977-0296 TEL. (518) 897-1234	232 GOLF COURSE ROAD WARRENSBURG, NY 12885-1172 TEL. (518) 623-1200
6	HERKIMER, JEFFERSON, LEWIS, ONEIDA AND ST. LAWRENCE	STATE OFFICE BUILDING 317 WASHINGTON STREET WATERTOWN, NY 13601-3787 TEL. (315) 785-2245	STATE OFFICE BUILDING 207 GENESEE STREET UTICA, NY 13501-2885 TEL. (315) 793-2554
7	BROOME, CAYUGA, CHENANGO, CORTLAND, MADISON, ONONDAGA, OSWEGO, TIOGA AND TOMPKINS	5786 WIDEWATERS PARKWAY SYRACUSE, NY 13214-1867 TEL. (315) 426-7438	5786 WIDEWATERS PARKWAY SYRACUSE, NY 13214-1867 TEL. (315) 426-7500
8	CHEMUNG, GENESEE, LIVINGSTON, MONROE, ONTARIO, ORLEANS, SCHUYLER, SENECA, STEBEN, WAYNE AND YATES	6274 EAST AVON-LIMA ROADAVON, NY 14414-9519 TEL. (585) 226-2466	6274 EAST AVON-LIMA RD. AVON, NY 14414-9519 TEL. (585) 226-2466
9	ALLEGANY, CATTARAUGUS, CHAUTAUQUA, ERIE, NIAGARA AND WYOMING	700 DELAWARE AVENUE BUFFALO, NY 14209-2999 TEL. (716) 851-7165	700 DELAWARE AVENUE BUFFALO, NY 14209-2999 TEL. (716) 851-7070

APPENDIX F – SWPPP Preparer Certification Form

The SWPPP Preparer Certification Form required by this permit begins on the following page.



SWPPP Preparer Certification Form

SPDES Construction General Permit for Stormwater Discharges from Construction Activity, GP-0-25-001 (CGP)

(In accordance with CGP Part I.D.2.b., the completed form must be attached to the eNOI and submitted to NYSDEC via nForm.)

Project/Site Name:

eNOI Submission ID:

Owner/Operator Name:

Certification Statement – SWPPP Preparer

I hereby certify that the Stormwater Pollution Prevention Plan (SWPPP) has been prepared in accordance with the requirements of GP-0-25-001. I certify under penalty of law that the SWPPP and all attachments were prepared under my direction or supervision in accordance with a system designed to assure that qualified personnel properly gather and evaluate the information submitted. Based on my inquiry of the person or persons who manage the system, or those persons directly responsible for gathering the information, the information submitted is, to the best of my knowledge and belief, true, accurate, and complete. I am aware that there are significant penalties for submitting false information, including the possibility of fine and imprisonment for knowing violations.

SWPPP Preparer First Name

MI

SWPPP Preparer Last Name

Signature

Date

APPENDIX G – MS4 SWPPP Acceptance Form

The MS4 SWPPP Acceptance Form required by this permit begins on the following page.



Department of
Environmental
Conservation

MS4 SWPPP Acceptance Form

for construction activities seeking authorization under the

SPDES Construction General Permit for Stormwater Discharges from Construction Activity, GP-0-25-001 (CGP)

(In accordance with CGP Part I.D.2.b., the completed form must be attached to the eNOI and submitted to NYSDEC via nForm.)

I. Project Owner/Operator Information

1. Owner/Operator Name:

2. Contact Person:

3. Street Address:

4. City/State/Zip:

II. Project Site Information

5. Project/Site Name:

6. Street Address:

7. City/State/Zip:

III. Stormwater Pollution Prevention Plan (SWPPP) Review and Acceptance Information

8. SWPPP Reviewed by:

9. Title/Position:

10. Date Final SWPPP Reviewed and Accepted:

IV. Regulated MS4 Information

11. Name of MS4 Operator:

12. MS4 SPDES Permit Identification Number: NYR20A

13. Street Address:

14. City/State/Zip:

15. Telephone Number:

MS4 SWPPP Acceptance Form - continued

V. Certification Statement - MS4 Official (principal executive officer or ranking elected official) or Duly Authorized Representative

I hereby certify that the final Stormwater Pollution Prevention Plan (SWPPP) for the construction project identified in section II. of this form has been reviewed and meets the substantive requirements in the SPDES Construction General Permit (CGP) for Stormwater Discharges from Construction Activity, GP-0-25-001. Note: The MS4 Operator, through the acceptance of the SWPPP, assumes no responsibility for the accuracy and adequacy of the design included in the SWPPP. In addition, review and acceptance of the SWPPP by the MS4 Operator does not relieve the owner/operator or their SWPPP preparer of responsibility or liability for errors or omissions in the plan.

Printed Name¹:

Title/Position:

Signature:

Date:

VI. Additional Information

¹ Printed name of the principal executive officer or ranking elected official for the MS4 Operator or their duly authorized representative in accordance with CGP Part VII.J.2.

APPENDIX H – NYCDEP SWPPP Acceptance/Approval Form

The City of New York Department of Environmental Protection (NYCDEP) SWPPP Acceptance/Approval form required by this permit begins on the following page.



THE CITY OF NEW YORK
 DEPARTMENT OF ENVIRONMENTAL PROTECTION
 Bureau of Environmental Planning and Analysis
 59-17 Junction Blvd., 9th Floor; Flushing, NY 11373

SWPPP Acceptance/Approval

Application Number:

I. Project Owner/Operator Information
1. Owner/Operator Name:
2. Contact Person:
3. Street Address:
4. City/State/Zip:
II. Project Site Information
5. Project/Site Name:
6. Street Address:
7. City/State/Zip:
III. Stormwater Pollution Prevention Plan (SWPPP) Review and Acceptance/Approval
8. SWPPP Reviewed by:
9. Title/Position: /
10. Date Final SWPPP Reviewed and Accepted:
11. Acceptance/Approval Expiration Date:
IV. Regulated MS4 Information for projects that require coverage under the NY State Pollution Discharge Elimination System General Permit for Stormwater Discharges from Construction Activity
12. Name of MS4: <i>CITY OF NEW YORK</i>
13. MS4 SPDES Permit Identification Number: <i>NY-0287890</i>
14. Contact Person:
15. Street Address: <i>59-17 Junction Blvd. 9th Floor</i>
16. City/State/Zip: <i>Flushing, NY 11373</i>
17. Telephone Number:



Projects in the MS4 area must submit a copy of this SWPPP Acceptance with a Notice of Intent for coverage under the NY SPDES General Permit for Stormwater Discharges from Construction Activity to: NYS Department of Environmental Conservation, Division of Water; 625 Broadway, 4th Floor; Albany, New York 12233-3505.



THE CITY OF NEW YORK
DEPARTMENT OF ENVIRONMENTAL PROTECTION
Bureau of Environmental Planning and Analysis
59-17 Junction Blvd., 9th Floor; Flushing, NY 11373

V. Certification Statement - MS4 Official (principal executive officer or ranking elected official) or Duly Authorized Representative

I hereby certify that the final Stormwater Pollution Prevention Plan (SWPPP) for the construction project identified in question 5 has been reviewed and meets the substantive requirements in the SPDES General Permit For Stormwater Discharges from Municipal Separate Storm Sewer Systems (MS4s).

Note: The MS4, through the acceptance of the SWPPP, assumes no responsibility for the accuracy and adequacy of the design included in the SWPPP. In addition, review and acceptance of the SWPPP by the MS4 does not relieve the owner/operator or their SWPPP preparer of responsibility or liability for errors or omissions in the plan.

Printed Name:

Title/Position:

Signature:

Date:

VI. Conditions of Acceptance/Approval and Additional Information



Projects in the MS4 area must submit a copy of this SWPPP Acceptance with a Notice of Intent for coverage under the NY SPDES General Permit for Stormwater Discharges from Construction Activity to: NYS Department of Environmental Conservation, Division of Water; 625 Broadway, 4th Floor; Albany, New York 12233-3505.

APPENDIX I – MS4 No Jurisdiction Form

The MS4 No Jurisdiction Form required by this permit begins on the following page.



Department of
Environmental
Conservation

MS4 No Jurisdiction Form

for Construction Activities seeking authorization under the

SPDES Construction General Permit for Stormwater Discharges from Construction Activity, GP-0-25-001 (CGP)

(In accordance with CGP Part I.D.2.b., the completed form must be attached to the eNOI and submitted to NYSDEC via nForm.)

I. Project Owner/Operator Information

- a. Owner/Operator Name:
- b. Contact Person:
- c. Street Address:
- d. City/State/Zip:

II. Project Site Information

- a. Project/Site Name:
- b. Street Address:
- c. City/State/Zip:
- d. eNOI Submission ID:

III. Traditional Land Use Control MS4 Operator Information

- a. Name of MS4 Operator:
- b. MS4 SPDES Permit ID Number: NYR20A
- c. Street Address:
- d. City/State/Zip:
- e. Telephone Number:

IV. Certification Statement

In accordance with CGP Part I.D.2.b.ii.3., I hereby certify that the Traditional Land Use Control MS4 Operator identified in section III. of this form does not have review authority over the construction project identified in section II. of this form, which is owned/operated by the entity identified in section I. of this form. I am aware that there are significant penalties for submitting false information, including the possibility of fine and imprisonment for knowing violations.

- a. Printed name of the principal executive officer or ranking elected official for the MS4 Operator or their duly authorized representative in accordance with CGP Part VII.J.2.:
- b. Title/Position:
- c. Signature:
- d. Date:

APPENDIX J – Owner/Operator Certification Form

The Owner/Operator Certification Form required by this permit begins on the following page.



Owner/Operator Certification Form

SPDES Construction General Permit for Stormwater Discharges from Construction Activity, GP-0-25-001 (CGP)

(In accordance with CGP Part I.D.2.b. or Part I.F.2. and 3., the completed form must be attached to the eNOI or the Request to Continue Coverage, and submitted to NYSDEC via nForm.

Project/Site Name: _____

eNOI Submission ID: _____

eNOI Submitted by: **Owner/Operator** **SWPPP Preparer** **Other**

Certification Statement - Owner/Operator

I hereby certify that I read, and will comply with, the GP-0-25-001 permit requirements. I understand that authorization to discharge under the permit for the project/site named above is dependent on receipt of a Letter of Authorization or a Letter of Continued Coverage from the New York State Department of Environmental Conservation (NYSDEC) in accordance with CGP Part I.D.3.b. or Part I.F.4. I am aware that there are significant penalties for submitting false information, including the possibility of fine and imprisonment for knowing violations.

Owner/Operator First Name MI Owner/Operator Last Name

Signature

Date

Appendix 5 | Draft Notice of Intent (N.O.I.)

NOI for coverage under Stormwater General Permit for Construction Activity

version 1.38

(Submission #: HQ4-9BKT-DGJ7V, version 1)

Details

Originally Started By Tyler Scognamiglio

Alternate Identifier Dewpoint North

Submission ID HQ4-9BKT-DGJ7V

Submission Reason New

Status Draft

Form Input

Owner/Operator Information

Owner/Operator Name (Company/Private Owner/Municipality/Agency/Institution, etc.)
Dewpoint North LLC

Owner/Operator Contact Person Last Name (NOT CONSULTANT)
Neuman

Owner/Operator Contact Person First Name
Isaac

Owner/Operator Mailing Address
21 Philips Pkwy

City
Montvale

State
NJ

Zip
07645

Phone
8452024900

Email
isaac@rdmcp.com

Federal Tax ID
NONE PROVIDED

If the owner/operator is an organization, provide the Federal Tax ID number, or Employer Identification Number (EIN), in the format xx-xxxxxx. If the owner/operator is an individual and not an organization, enter "Not Applicable" or "N/A" and do not provide the individual's social security number.

Project Location

Project/Site Name
Dewpoint North

Street Address (Not P.O. Box)
Dolsontown Road (Opposite Caskey Lane)

Side of Street
North

City/Town/Village (THAT ISSUES BUILDING PERMIT)
Town of Wawayanda

State
NY

Zip
10973

DEC Region
3

The DEC Region must be provided. Please use the NYSDEC Stormwater Interactive Map (<https://gisservices.dec.ny.gov/gis/stormwater/>) to confirm which DEC Region this site is located in. To view the DEC Regions, click on "Other Useful Reference Layers" on the left side of the map, then click on "DEC Administrative Boundary." Zoom out as needed to see the Region boundaries.
For projects that span multiple Regions, please select a primary Region and then provide the additional Regions as a note in Question 39.

County
ORANGE

Name of Nearest Cross Street
Caskey Lane

Distance to Nearest Cross Street (Feet)

0

Project In Relation to Cross Street

North

Tax Map Numbers Section-Block-Parcel

4-1-50.2

Tax Map Numbers

NONE PROVIDED

If the project does not have tax map numbers (e.g. linear projects), enter "Not Applicable" or "N/A".

1. Coordinates

Provide the Geographic Coordinates for the project site. The two methods are:

- Navigate to the project location on the map (below) and click to place a marker and obtain the XY coordinates.
- The "Find Me" button will provide the lat/long for the person filling out this form. Then pan the map to the correct location and click the map to place a marker and obtain the XY coordinates.

Navigate to your location and click on the map to get the X,Y coordinates

41.423662761175834,-74.42285638968954

Project Details**2. What is the nature of this project?**

New Construction

For the purposes of this eNOI, "New Construction" refers to any project that does not involve the disturbance of existing impervious area (i.e. 0 acres). If existing impervious area will be disturbed on the project site, it is considered redevelopment with either increase in impervious area or no increase in impervious area.

3. Select the predominant land use for both pre and post development conditions.**Pre-Development Existing Landuse**

Forest

Post-Development Future Land Use

Commercial

3a. If Single Family Subdivision was selected in question 3, enter the number of subdivision lots.

NONE PROVIDED

4. In accordance with the larger common plan of development or sale, enter the total project site acreage, the acreage to be disturbed and the future impervious area (acreage)within the disturbed area.

*** ROUND TO THE NEAREST TENTH OF AN ACRE. ***

Total Site Area (acres)

6.1

Total Area to be Disturbed (acres)

3.8

Existing Impervious Area to be Disturbed (acres)

0.4

Future Impervious Area Within Disturbed Area (acres)

1.9

5. Do you plan to disturb more than 5 acres of soil at any one time?

No

6. Indicate the percentage (%) of each Hydrologic Soil Group(HSG) at the site.

A (%)

0

B (%)

0

C (%)

0

D (%)

100

7. Is this a phased project?

No

8. Enter the planned start and end dates of the disturbance activities.**Start Date**

01/01/2025

End Date

12/31/2025

9. Identify the nearest surface waterbody(ies) to which construction site runoff will discharge.

On-site wetlands & Monhagen Brook

Drainage ditches and storm sewer systems are not considered surface waterbodies. Please identify the surface waterbody that they discharge to. If the nearest surface waterbody is unnamed, provide a description of the waterbody, such as, "Unnamed tributary to Niagara River."

9a. Type of waterbody identified in question 9?

Stream/Creek On Site
Wetland/Federal Jurisdiction On Site (Answer 9b)

Other Waterbody Type Off Site Description

NONE PROVIDED

9b. If "wetland" was selected in 9A, how was the wetland identified?

Delineated by Consultant

10. Has the surface waterbody(ies) in question 9 been identified as a 303(d) segment in Appendix E of GP-0-20-001?

Yes

11. Is this project located in one of the Watersheds identified in Appendix C of GP-0-20-001?

No

12. Is the project located in one of the watershed areas associated with AA and AA-S classified waters?

No

Please use the DEC Stormwater Interactive Map (<https://gisservices.dec.ny.gov/gis/stormwater/>) to confirm if this site is located in one of the watersheds of an AA or AA-S classified water. To view the watershed areas, click on "Permit Related Layers" on the left side of the map, then click on "Class AA AAS Watersheds."

If No, skip question 13.

13. Does this construction activity disturb land with no existing impervious cover and where the Soil Slope Phase is identified as D (provided the map unit name is inclusive of slopes greater than 25%), E or F on the USDA Soil Survey?

NONE PROVIDED

If Yes, what is the acreage to be disturbed?

NONE PROVIDED

14. Will the project disturb soils within a State regulated wetland or the protected 100 foot adjacent area?

No

15. Does the site runoff enter a separate storm sewer system (including roadside drains, swales, ditches, culverts, etc)?

No

16. What is the name of the municipality/entity that owns the separate storm sewer system?

NONE PROVIDED

17. Does any runoff from the site enter a sewer classified as a Combined Sewer?

No

18. Will future use of this site be an agricultural property as defined by the NYS Agriculture and Markets Law?

No

19. Is this property owned by a state authority, state agency, federal government or local government?

No

20. Is this a remediation project being done under a Department approved work plan? (i.e. CERCLA, RCRA, Voluntary Cleanup Agreement, etc.)

No

Required SWPPP Components

21. Has the required Erosion and Sediment Control component of the SWPPP been developed in conformance with the current NYS Standards and Specifications for Erosion and Sediment Control (aka Blue Book)?

Yes

22. Does this construction activity require the development of a SWPPP that includes the post-construction stormwater management practice component (i.e. Runoff Reduction, Water Quality and Quantity Control practices/techniques)?

Yes

If you answered No in question 22, skip question 23 and the Post-construction Criteria and Post-construction SMP Identification sections.

23. Has the post-construction stormwater management practice component of the SWPPP been developed in conformance with the current NYS Stormwater Management Design Manual?

Yes

24. The Stormwater Pollution Prevention Plan (SWPPP) was prepared by:

Professional Engineer (P.E.)

SWPPP Preparer

Colliers Engineering & Design CT, PC

Contact Name (Last, First)

Robinson, Cory

Mailing Address

555 Hudson Valley Ave, Ste 101

City

New Windsor

State

NY

Zip

12553

Phone

8455644495

Email

cory.robinson@collierseng.com

Download SWPPP Preparer Certification Form

Please take the following steps to prepare and upload your preparer certification form:

- 1) Click on the link below to download a blank certification form
 - 2) The certified SWPPP preparer should sign this form
 - 3) Scan the signed form
 - 4) Upload the scanned document
- [Download SWPPP Preparer Certification Form](#)

Please upload the SWPPP Preparer Certification

NONE PROVIDED

Comment

NONE PROVIDED

Erosion & Sediment Control Criteria**25. Has a construction sequence schedule for the planned management practices been prepared?**

Yes

26. Select all of the erosion and sediment control practices that will be employed on the project site:**Temporary Structural**

Check Dams
Sediment Basin
Sediment Traps
Silt Fence
Stabilized Construction Entrance
Storm Drain Inlet Protection
Temporary Swale

Biotechnical

Brush Matting

Vegetative Measures

Brush Matting
Mulching
Seeding
Temporary Swale
Topsoiling

Permanent Structural

Retaining Wall
Rock Outlet Protection

Other

NONE PROVIDED

Post-Construction Criteria*** IMPORTANT: Completion of Questions 27-39 is not required if response to Question 22 is No.****27. Identify all site planning practices that were used to prepare the final site plan/layout for the project.**

NONE PROVIDED

27a. Indicate which of the following soil restoration criteria was used to address the requirements in Section 5.1.6("Soil Restoration") of the Design Manual (2010 version).

All disturbed areas will be restored in accordance with the Soil Restoration requirements in Table 5.3 of the Design Manual (see page 5-22).

28. Provide the total Water Quality Volume (WQv) required for this project (based on final site plan/layout). (Acre-feet)

0.213

29. Post-construction SMP Identification

Use the Post-construction SMP Identification section to identify the RR techniques (Area Reduction), RR techniques(Volume Reduction) and Standard SMPs with RRv Capacity that were used to reduce the Total WQv Required (#28).

Identify the SMPs to be used by providing the total impervious area that contributes runoff to each technique/practice selected. For the Area Reduction Techniques, provide the total contributing area (includes pervious area) and, if applicable, the total impervious area that contributes runoff to the technique/practice.

Note: Redevelopment projects shall use the Post-Construction SMP Identification section to identify the SMPs used to treat and/or reduce the WQv required. If runoff reduction techniques will not be used to reduce the required WQv, skip to question 33a after identifying the SMPs.

30. Indicate the Total RRv provided by the RR techniques (Area/Volume Reduction) and Standard SMPs with RRv capacity identified in question 29. (acre-feet)

0.124

31. Is the Total RRv provided (#30) greater than or equal to the total WQv required (#28)?

No

If Yes, go to question 36. If No, go to question 32.

32. Provide the Minimum RRv required based on HSG. [Minimum RRv Required = (P) (0.95) (Ai) / 12, Ai=(s) (Aic)] (acre-feet)

0.042

32a. Is the Total RRv provided (#30) greater than or equal to the Minimum RRv Required (#32)?

Yes

If Yes, go to question 33.

Note: Use the space provided in question #39 to summarize the specific site limitations and justification for not reducing 100% of WQv required (#28). A detailed evaluation of the specific site limitations and justification for not reducing 100% of the WQv required (#28) must also be included in the SWPPP.

If No, sizing criteria has not been met; therefore, NOI can not be processed. SWPPP preparer must modify design to meet sizing criteria.

33. SMPs

Use the Post-construction SMP Identification section to identify the Standard SMPs and, if applicable, the Alternative SMPs to be used to treat the remaining total WQv (=Total WQv Required in #28 - Total RRv Provided in #30).

Also, provide the total impervious area that contributes runoff to each practice selected.

NOTE: Use the Post-construction SMP Identification section to identify the SMPs used on Redevelopment projects.

33a. Indicate the Total WQv provided (i.e. WQv treated) by the SMPs identified in question #33 and Standard SMPs with RRv Capacity identified in question #29. (acre-feet)
0.213

Note: For the standard SMPs with RRv capacity, the WQv provided by each practice = the WQv calculated using the contributing drainage area to the practice - provided by the practice. (See Table 3.5 in Design Manual)

34. Provide the sum of the Total RRv provided (#30) and the WQv provided (#33a).
0.337

35. Is the sum of the RRv provided (#30) and the WQv provided (#33a) greater than or equal to the total WQv required (#28)?
Yes

If Yes, go to question 36.

If No, sizing criteria has not been met; therefore, NOI can not be processed. SWPPP preparer must modify design to meet sizing criteria.

36. Provide the total Channel Protection Storage Volume (CPv required and provided or select waiver (#36a), if applicable.

CPv Required (acre-feet)
NONE PROVIDED

CPv Provided (acre-feet)
NONE PROVIDED

36a. The need to provide channel protection has been waived because:
NONE PROVIDED

37. Provide the Overbank Flood (Qp) and Extreme Flood (Qf) control criteria or select waiver (#37a), if applicable.

Overbank Flood Control Criteria (Qp)

Pre-Development (CFS)
NONE PROVIDED

Post-Development (CFS)
NONE PROVIDED

Total Extreme Flood Control Criteria (Qf)

Pre-Development (CFS)
NONE PROVIDED

Post-Development (CFS)
NONE PROVIDED

37a. The need to meet the Qp and Qf criteria has been waived because:
NONE PROVIDED

38. Has a long term Operation and Maintenance Plan for the post-construction stormwater management practice(s) been developed?
Yes

If Yes, Identify the entity responsible for the long term Operation and Maintenance
Dewpoint North LLC

39. Use this space to summarize the specific site limitations and justification for not reducing 100% of WQv required (#28). (See question #32a) This space can also be used for other pertinent project information.
NONE PROVIDED

Post-Construction SMP Identification

Runoff Reduction (RR) Techniques, Standard Stormwater Management Practices (SMPs) and Alternative SMPs

Identify the Post-construction SMPs to be used by providing the total impervious area that contributes runoff to each technique/practice selected. For the Area Reduction Techniques, provide the total contributing area (includes pervious area) and, if applicable, the total impervious area that contributes runoff to the technique/practice.

RR Techniques (Area Reduction)

Round to the nearest tenth

Total Contributing Acres for Conservation of Natural Area (RR-1)
NONE PROVIDED

Total Contributing Impervious Acres for Conservation of Natural Area (RR-1)
NONE PROVIDED

Total Contributing Acres for Sheetflow to Riparian Buffers/Filter Strips (RR-2)
NONE PROVIDED

Total Contributing Impervious Acres for Sheetflow to Riparian Buffers/Filter Strips (RR-2)
NONE PROVIDED

Total Contributing Acres for Tree Planting/Tree Pit (RR-3)
NONE PROVIDED

Total Contributing Impervious Acres for Tree Planting/Tree Pit (RR-3)
NONE PROVIDED

Total Contributing Acres for Disconnection of Rooftop Runoff (RR-4)
NONE PROVIDED

RR Techniques (Volume Reduction)

Total Contributing Impervious Acres for Disconnection of Rooftop Runoff (RR-4)
NONE PROVIDED

Total Contributing Impervious Acres for Vegetated Swale (RR-5)
NONE PROVIDED

Total Contributing Impervious Acres for Rain Garden (RR-6)
NONE PROVIDED

Total Contributing Impervious Acres for Stormwater Planter (RR-7)
NONE PROVIDED

Total Contributing Impervious Acres for Rain Barrel/Cistern (RR-8)
NONE PROVIDED

Total Contributing Impervious Acres for Porous Pavement (RR-9)
NONE PROVIDED

Total Contributing Impervious Acres for Green Roof (RR-10)
NONE PROVIDED

Standard SMPs with RRv Capacity

Total Contributing Impervious Acres for Infiltration Trench (I-1)
NONE PROVIDED

Total Contributing Impervious Acres for Infiltration Basin (I-2)
NONE PROVIDED

Total Contributing Impervious Acres for Dry Well (I-3)
NONE PROVIDED

Total Contributing Impervious Acres for Underground Infiltration System (I-4)
NONE PROVIDED

Total Contributing Impervious Acres for Bioretention (F-5)
1.89

Total Contributing Impervious Acres for Dry Swale (O-1)
NONE PROVIDED

Standard SMPs

Total Contributing Impervious Acres for Micropool Extended Detention (P-1)
NONE PROVIDED

Total Contributing Impervious Acres for Wet Pond (P-2)
NONE PROVIDED

Total Contributing Impervious Acres for Wet Extended Detention (P-3)
NONE PROVIDED

Total Contributing Impervious Acres for Multiple Pond System (P-4)
NONE PROVIDED

Total Contributing Impervious Acres for Pocket Pond (P-5)
NONE PROVIDED

Total Contributing Impervious Acres for Surface Sand Filter (F-1)
NONE PROVIDED

Total Contributing Impervious Acres for Underground Sand Filter (F-2)
NONE PROVIDED

Total Contributing Impervious Acres for Perimeter Sand Filter (F-3)
NONE PROVIDED

Total Contributing Impervious Acres for Organic Filter (F-4)
NONE PROVIDED

Total Contributing Impervious Acres for Shallow Wetland (W-1)
NONE PROVIDED

Total Contributing Impervious Acres for Extended Detention Wetland (W-2)
NONE PROVIDED

Total Contributing Impervious Acres for Pond/Wetland System (W-3)
NONE PROVIDED

Total Contributing Impervious Acres for Pocket Wetland (W-4)
NONE PROVIDED

Total Contributing Impervious Acres for Wet Swale (O-2)
NONE PROVIDED

Alternative SMPs (DO NOT INCLUDE PRACTICES BEING USED FOR PRETREATMENT ONLY)

Total Contributing Impervious Area for Hydrodynamic
NONE PROVIDED

Total Contributing Impervious Area for Wet Vault
NONE PROVIDED

Total Contributing Impervious Area for Media Filter
NONE PROVIDED

"Other" Alternative SMP?
NONE PROVIDED

Total Contributing Impervious Area for "Other"
NONE PROVIDED

Provide the name and manufacturer of the alternative SMPs (i.e. proprietary practice(s)) being used for WQv treatment.

Note: Redevelopment projects which do not use RR techniques, shall use questions 28, 29, 33 and 33a to provide SMPs used, total WQv required and total WQv provided for the project.

Manufacturer of Alternative SMP
NONE PROVIDED

Name of Alternative SMP
NONE PROVIDED

Other Permits

40. Identify other DEC permits, existing and new, that are required for this project/facility.
None

If SPDES Multi-Sector GP, then give permit ID
NONE PROVIDED

If Other, then identify
NONE PROVIDED

41. Does this project require a US Army Corps of Engineers Wetland Permit?
No

If "Yes," then indicate Size of Impact, in acres, to the nearest tenth
NONE PROVIDED

42. If this NOI is being submitted for the purpose of continuing or transferring coverage under a general permit for stormwater runoff from construction activities, please indicate the former SPDES number assigned.
NONE PROVIDED

MS4 SWPPP Acceptance

43. Is this project subject to the requirements of a regulated, traditional land use control MS4?
Yes - Please attach the MS4 Acceptance form below

If No, skip question 44

44. Has the "MS4 SWPPP Acceptance" form been signed by the principal executive officer or ranking elected official and submitted along with this NOI?
No

Please note that per Part VII.H.4. of GP-0-20-001, the MS4 SWPPP Acceptance Form must be signed by a principal executive officer or ranking elected official of the MS4, or a duly authorized representative of that person.

MS4 SWPPP Acceptance Form Download

Download form from the link below. Complete, sign, and upload.
[MS4 SWPPP Acceptance Form](#)

MS4 Acceptance Form Upload
NONE PROVIDED
Comment
NONE PROVIDED

Owner/Operator Certification

Owner/Operator Certification Form Download

Download the certification form by clicking the link below. Complete, sign, scan, and upload the form.
[Owner/Operator Certification Form \(PDF, 45KB\)](#)

Upload Owner/Operator Certification Form
NONE PROVIDED
Comment
NONE PROVIDED

Appendix 6 | Draft Notice of Termination (N.O.T.)

**New York State Department of Environmental Conservation
Division of Water
625 Broadway, 4th Floor
Albany, New York 12233-3505**

(NOTE: Submit completed form to address above)

**NOTICE OF TERMINATION for Storm Water Discharges Authorized
under the SPDES General Permit for Construction Activity**

Please indicate your permit identification number: NYR _____

I. Owner or Operator Information

1. Owner/Operator Name:

2. Street Address:

3. City/State/Zip:

4. Contact Person:

4a. Telephone:

4b. Contact Person E-Mail:

II. Project Site Information

5. Project/Site Name:

6. Street Address:

7. City/Zip:

8. County:

III. Reason for Termination

9a. All disturbed areas have achieved final stabilization in accordance with the general permit and SWPPP. *Date final stabilization completed (month/year): _____

9b. Permit coverage has been transferred to new owner/operator. Indicate new owner/operator's permit identification number: NYR _____

(Note: Permit coverage can not be terminated by owner identified in I.1. above until new owner/operator obtains coverage under the general permit)

9c. Other (Explain on Page 2)

IV. Final Site Information:

10a. Did this construction activity require the development of a SWPPP that includes post-construction stormwater management practices? yes no (If no, go to question 10f.)

10b. Have all post-construction stormwater management practices included in the final SWPPP been constructed? yes no (If no, explain on Page 2)

10c. Identify the entity responsible for long-term operation and maintenance of practice(s)?

**NOTICE OF TERMINATION for Storm Water Discharges Authorized under the
SPDES General Permit for Construction Activity - continued**

10d. Has the entity responsible for long-term operation and maintenance been given a copy of the operation and maintenance plan required by the general permit? yes no

10e. Indicate the method used to ensure long-term operation and maintenance of the post-construction stormwater management practice(s):

- Post-construction stormwater management practice(s) and any right-of-way(s) needed to maintain practice(s) have been deeded to the municipality.
- Executed maintenance agreement is in place with the municipality that will maintain the post-construction stormwater management practice(s).
- For post-construction stormwater management practices that are privately owned, a mechanism is in place that requires operation and maintenance of the practice(s) in accordance with the operation and maintenance plan, such as a deed covenant in the owner or operator's deed of record.
- For post-construction stormwater management practices that are owned by a public or private institution (e.g. school, university or hospital), government agency or authority, or public utility; policy and procedures are in place that ensures operation and maintenance of the practice(s) in accordance with the operation and maintenance plan.

10f. Provide the total area of impervious surface (i.e. roof, pavement, concrete, gravel, etc.) constructed within the disturbance area? _____
(acres)

11. Is this project subject to the requirements of a regulated, traditional land use control MS4? yes
 no
(If Yes, complete section VI - "MS4 Acceptance" statement)

V. Additional Information/Explanation:
(Use this section to answer questions 9c. and 10b., if applicable)

VI. MS4 Acceptance - MS4 Official (principal executive officer or ranking elected official) or Duly Authorized Representative (Note: Not required when 9b. is checked -transfer of coverage)

I have determined that it is acceptable for the owner or operator of the construction project identified in question 5 to submit the Notice of Termination at this time.

Printed Name:

Title/Position:

Signature:

Date:

NOTICE OF TERMINATION for Storm Water Discharges Authorized under the
SPDES General Permit for Construction Activity - continued

VII. Qualified Inspector Certification - Final Stabilization:

I hereby certify that all disturbed areas have achieved final stabilization as defined in the current version of the general permit, and that all temporary, structural erosion and sediment control measures have been removed. Furthermore, I understand that certifying false, incorrect or inaccurate information is a violation of the referenced permit and the laws of the State of New York and could subject me to criminal, civil and/or administrative proceedings.

Printed Name:

Title/Position:

Signature:

Date:

VIII. Qualified Inspector Certification - Post-construction Stormwater Management Practice(s):

I hereby certify that all post-construction stormwater management practices have been constructed in conformance with the SWPPP. Furthermore, I understand that certifying false, incorrect or inaccurate information is a violation of the referenced permit and the laws of the State of New York and could subject me to criminal, civil and/or administrative proceedings.

Printed Name:

Title/Position:

Signature:

Date:

IX. Owner or Operator Certification

I hereby certify that this document was prepared by me or under my direction or supervision. My determination, based upon my inquiry of the person(s) who managed the construction activity, or those persons directly responsible for gathering the information, is that the information provided in this document is true, accurate and complete. Furthermore, I understand that certifying false, incorrect or inaccurate information is a violation of the referenced permit and the laws of the State of New York and could subject me to criminal, civil and/or administrative proceedings.

Printed Name:

Title/Position:

Signature:

Date:

(NYS DEC Notice of Termination - January 2015)

Appendix 7 | Draft MS4 Acceptance Form



Department of
Environmental
Conservation

NYS Department of Environmental Conservation
Division of Water
625 Broadway, 4th Floor
Albany, New York 12233-3505

MS4 Stormwater Pollution Prevention Plan (SWPPP) Acceptance Form

for

Construction Activities Seeking Authorization Under SPDES General Permit
*(NOTE: Attach Completed Form to Notice Of Intent and Submit to Address Above)

I. Project Owner/Operator Information

1. Owner/Operator Name:

2. Contact Person:

3. Street Address:

4. City/State/Zip:

II. Project Site Information

5. Project/Site Name:

6. Street Address:

7. City/State/Zip:

III. Stormwater Pollution Prevention Plan (SWPPP) Review and Acceptance Information

8. SWPPP Reviewed by:

9. Title/Position:

10. Date Final SWPPP Reviewed and Accepted:

IV. Regulated MS4 Information

11. Name of MS4:

12. MS4 SPDES Permit Identification Number: NYR20A

13. Contact Person:

14. Street Address:

15. City/State/Zip:

16. Telephone Number:

MS4 SWPPP Acceptance Form - continued

V. Certification Statement - MS4 Official (principal executive officer or ranking elected official) or Duly Authorized Representative

I hereby certify that the final Stormwater Pollution Prevention Plan (SWPPP) for the construction project identified in question 5 has been reviewed and meets the substantive requirements in the SPDES General Permit For Stormwater Discharges from Municipal Separate Storm Sewer Systems (MS4s).
Note: The MS4, through the acceptance of the SWPPP, assumes no responsibility for the accuracy and adequacy of the design included in the SWPPP. In addition, review and acceptance of the SWPPP by the MS4 does not relieve the owner/operator or their SWPPP preparer of responsibility or liability for errors or omissions in the plan.

Printed Name:

Title/Position:

Signature:

Date:

VI. Additional Information

Appendix 8 | NRCS Hydrologic Soil Mapping

Custom Soil Resource Report for Orange County, New York



Preface

Soil surveys contain information that affects land use planning in survey areas. They highlight soil limitations that affect various land uses and provide information about the properties of the soils in the survey areas. Soil surveys are designed for many different users, including farmers, ranchers, foresters, agronomists, urban planners, community officials, engineers, developers, builders, and home buyers. Also, conservationists, teachers, students, and specialists in recreation, waste disposal, and pollution control can use the surveys to help them understand, protect, or enhance the environment.

Various land use regulations of Federal, State, and local governments may impose special restrictions on land use or land treatment. Soil surveys identify soil properties that are used in making various land use or land treatment decisions. The information is intended to help the land users identify and reduce the effects of soil limitations on various land uses. The landowner or user is responsible for identifying and complying with existing laws and regulations.

Although soil survey information can be used for general farm, local, and wider area planning, onsite investigation is needed to supplement this information in some cases. Examples include soil quality assessments (<http://www.nrcs.usda.gov/wps/portal/nrcs/main/soils/health/>) and certain conservation and engineering applications. For more detailed information, contact your local USDA Service Center (<https://offices.sc.egov.usda.gov/locator/app?agency=nrcs>) or your NRCS State Soil Scientist (http://www.nrcs.usda.gov/wps/portal/nrcs/detail/soils/contactus/?cid=nrcs142p2_053951).

Great differences in soil properties can occur within short distances. Some soils are seasonally wet or subject to flooding. Some are too unstable to be used as a foundation for buildings or roads. Clayey or wet soils are poorly suited to use as septic tank absorption fields. A high water table makes a soil poorly suited to basements or underground installations.

The National Cooperative Soil Survey is a joint effort of the United States Department of Agriculture and other Federal agencies, State agencies including the Agricultural Experiment Stations, and local agencies. The Natural Resources Conservation Service (NRCS) has leadership for the Federal part of the National Cooperative Soil Survey.

Information about soils is updated periodically. Updated information is available through the NRCS Web Soil Survey, the site for official soil survey information.

The U.S. Department of Agriculture (USDA) prohibits discrimination in all its programs and activities on the basis of race, color, national origin, age, disability, and where applicable, sex, marital status, familial status, parental status, religion, sexual orientation, genetic information, political beliefs, reprisal, or because all or a part of an individual's income is derived from any public assistance program. (Not all prohibited bases apply to all programs.) Persons with disabilities who require

alternative means for communication of program information (Braille, large print, audiotape, etc.) should contact USDA's TARGET Center at (202) 720-2600 (voice and TDD). To file a complaint of discrimination, write to USDA, Director, Office of Civil Rights, 1400 Independence Avenue, S.W., Washington, D.C. 20250-9410 or call (800) 795-3272 (voice) or (202) 720-6382 (TDD). USDA is an equal opportunity provider and employer.

Contents

Preface	2
How Soil Surveys Are Made	5
Soil Map	8
Soil Map.....	9
Legend.....	10
Map Unit Legend.....	11
Map Unit Descriptions.....	11
Orange County, New York.....	13
ErB—Erie gravelly silt loam, 3 to 8 percent slopes.....	13
MdB—Mardin gravelly silt loam, 3 to 8 percent slopes.....	14
MdC—Mardin gravelly silt loam, 8 to 15 percent slopes.....	15
Soil Information for All Uses	18
Soil Properties and Qualities.....	18
Soil Qualities and Features.....	18
Hydrologic Soil Group.....	18
References	23

How Soil Surveys Are Made

Soil surveys are made to provide information about the soils and miscellaneous areas in a specific area. They include a description of the soils and miscellaneous areas and their location on the landscape and tables that show soil properties and limitations affecting various uses. Soil scientists observed the steepness, length, and shape of the slopes; the general pattern of drainage; the kinds of crops and native plants; and the kinds of bedrock. They observed and described many soil profiles. A soil profile is the sequence of natural layers, or horizons, in a soil. The profile extends from the surface down into the unconsolidated material in which the soil formed or from the surface down to bedrock. The unconsolidated material is devoid of roots and other living organisms and has not been changed by other biological activity.

Currently, soils are mapped according to the boundaries of major land resource areas (MLRAs). MLRAs are geographically associated land resource units that share common characteristics related to physiography, geology, climate, water resources, soils, biological resources, and land uses (USDA, 2006). Soil survey areas typically consist of parts of one or more MLRA.

The soils and miscellaneous areas in a survey area occur in an orderly pattern that is related to the geology, landforms, relief, climate, and natural vegetation of the area. Each kind of soil and miscellaneous area is associated with a particular kind of landform or with a segment of the landform. By observing the soils and miscellaneous areas in the survey area and relating their position to specific segments of the landform, a soil scientist develops a concept, or model, of how they were formed. Thus, during mapping, this model enables the soil scientist to predict with a considerable degree of accuracy the kind of soil or miscellaneous area at a specific location on the landscape.

Commonly, individual soils on the landscape merge into one another as their characteristics gradually change. To construct an accurate soil map, however, soil scientists must determine the boundaries between the soils. They can observe only a limited number of soil profiles. Nevertheless, these observations, supplemented by an understanding of the soil-vegetation-landscape relationship, are sufficient to verify predictions of the kinds of soil in an area and to determine the boundaries.

Soil scientists recorded the characteristics of the soil profiles that they studied. They noted soil color, texture, size and shape of soil aggregates, kind and amount of rock fragments, distribution of plant roots, reaction, and other features that enable them to identify soils. After describing the soils in the survey area and determining their properties, the soil scientists assigned the soils to taxonomic classes (units). Taxonomic classes are concepts. Each taxonomic class has a set of soil characteristics with precisely defined limits. The classes are used as a basis for comparison to classify soils systematically. Soil taxonomy, the system of taxonomic classification used in the United States, is based mainly on the kind and character of soil properties and the arrangement of horizons within the profile. After the soil

Custom Soil Resource Report

scientists classified and named the soils in the survey area, they compared the individual soils with similar soils in the same taxonomic class in other areas so that they could confirm data and assemble additional data based on experience and research.

The objective of soil mapping is not to delineate pure map unit components; the objective is to separate the landscape into landforms or landform segments that have similar use and management requirements. Each map unit is defined by a unique combination of soil components and/or miscellaneous areas in predictable proportions. Some components may be highly contrasting to the other components of the map unit. The presence of minor components in a map unit in no way diminishes the usefulness or accuracy of the data. The delineation of such landforms and landform segments on the map provides sufficient information for the development of resource plans. If intensive use of small areas is planned, onsite investigation is needed to define and locate the soils and miscellaneous areas.

Soil scientists make many field observations in the process of producing a soil map. The frequency of observation is dependent upon several factors, including scale of mapping, intensity of mapping, design of map units, complexity of the landscape, and experience of the soil scientist. Observations are made to test and refine the soil-landscape model and predictions and to verify the classification of the soils at specific locations. Once the soil-landscape model is refined, a significantly smaller number of measurements of individual soil properties are made and recorded. These measurements may include field measurements, such as those for color, depth to bedrock, and texture, and laboratory measurements, such as those for content of sand, silt, clay, salt, and other components. Properties of each soil typically vary from one point to another across the landscape.

Observations for map unit components are aggregated to develop ranges of characteristics for the components. The aggregated values are presented. Direct measurements do not exist for every property presented for every map unit component. Values for some properties are estimated from combinations of other properties.

While a soil survey is in progress, samples of some of the soils in the area generally are collected for laboratory analyses and for engineering tests. Soil scientists interpret the data from these analyses and tests as well as the field-observed characteristics and the soil properties to determine the expected behavior of the soils under different uses. Interpretations for all of the soils are field tested through observation of the soils in different uses and under different levels of management. Some interpretations are modified to fit local conditions, and some new interpretations are developed to meet local needs. Data are assembled from other sources, such as research information, production records, and field experience of specialists. For example, data on crop yields under defined levels of management are assembled from farm records and from field or plot experiments on the same kinds of soil.

Predictions about soil behavior are based not only on soil properties but also on such variables as climate and biological activity. Soil conditions are predictable over long periods of time, but they are not predictable from year to year. For example, soil scientists can predict with a fairly high degree of accuracy that a given soil will have a high water table within certain depths in most years, but they cannot predict that a high water table will always be at a specific level in the soil on a specific date.

After soil scientists located and identified the significant natural bodies of soil in the survey area, they drew the boundaries of these bodies on aerial photographs and

Custom Soil Resource Report

identified each as a specific map unit. Aerial photographs show trees, buildings, fields, roads, and rivers, all of which help in locating boundaries accurately.

Soil Map

The soil map section includes the soil map for the defined area of interest, a list of soil map units on the map and extent of each map unit, and cartographic symbols displayed on the map. Also presented are various metadata about data used to produce the map, and a description of each soil map unit.

Custom Soil Resource Report Soil Map



Soil Map may not be valid at this scale.

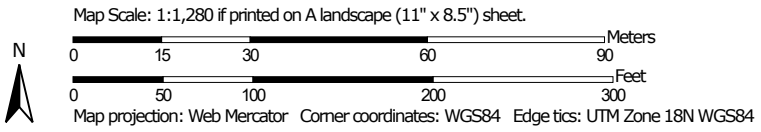

MAP LEGEND

Area of Interest (AOI)

 Area of Interest (AOI)

Soils

 Soil Map Unit Polygons

 Soil Map Unit Lines

 Soil Map Unit Points

Special Point Features





-  Blowout
-  Borrow Pit
-  Clay Spot
-  Closed Depression
-  Gravel Pit
-  Gravelly Spot
-  Landfill
-  Lava Flow
-  Marsh or swamp
-  Mine or Quarry
-  Miscellaneous Water
-  Perennial Water
-  Rock Outcrop
-  Saline Spot
-  Sandy Spot
-  Severely Eroded Spot
-  Sinkhole
-  Slide or Slip
-  Sodic Spot

-  Spoil Area
-  Stony Spot
-  Very Stony Spot
-  Wet Spot
-  Other
-  Special Line Features

Water Features

 Streams and Canals

Transportation

-  Rails
-  Interstate Highways
-  US Routes
-  Major Roads
-  Local Roads

Background

 Aerial Photography

MAP INFORMATION

The soil surveys that comprise your AOI were mapped at 1:15,800.

Warning: Soil Map may not be valid at this scale.

Enlargement of maps beyond the scale of mapping can cause misunderstanding of the detail of mapping and accuracy of soil line placement. The maps do not show the small areas of contrasting soils that could have been shown at a more detailed scale.

Please rely on the bar scale on each map sheet for map measurements.

Source of Map: Natural Resources Conservation Service
 Web Soil Survey URL:
 Coordinate System: Web Mercator (EPSG:3857)

Maps from the Web Soil Survey are based on the Web Mercator projection, which preserves direction and shape but distorts distance and area. A projection that preserves area, such as the Albers equal-area conic projection, should be used if more accurate calculations of distance or area are required.

This product is generated from the USDA-NRCS certified data as of the version date(s) listed below.

Soil Survey Area: Orange County, New York
 Survey Area Data: Version 21, Jun 11, 2020

Soil map units are labeled (as space allows) for map scales 1:50,000 or larger.

Date(s) aerial images were photographed: Data not available.

The orthophoto or other base map on which the soil lines were compiled and digitized probably differs from the background imagery displayed on these maps. As a result, some minor shifting of map unit boundaries may be evident.

Map Unit Legend

Map Unit Symbol	Map Unit Name	Acres in AOI	Percent of AOI
ErB	Erie gravelly silt loam, 3 to 8 percent slopes	2.8	45.9%
MdB	Mardin gravelly silt loam, 3 to 8 percent slopes	0.4	6.3%
MdC	Mardin gravelly silt loam, 8 to 15 percent slopes	2.9	47.8%
Totals for Area of Interest		6.1	100.0%

Map Unit Descriptions

The map units delineated on the detailed soil maps in a soil survey represent the soils or miscellaneous areas in the survey area. The map unit descriptions, along with the maps, can be used to determine the composition and properties of a unit.

A map unit delineation on a soil map represents an area dominated by one or more major kinds of soil or miscellaneous areas. A map unit is identified and named according to the taxonomic classification of the dominant soils. Within a taxonomic class there are precisely defined limits for the properties of the soils. On the landscape, however, the soils are natural phenomena, and they have the characteristic variability of all natural phenomena. Thus, the range of some observed properties may extend beyond the limits defined for a taxonomic class. Areas of soils of a single taxonomic class rarely, if ever, can be mapped without including areas of other taxonomic classes. Consequently, every map unit is made up of the soils or miscellaneous areas for which it is named and some minor components that belong to taxonomic classes other than those of the major soils.

Most minor soils have properties similar to those of the dominant soil or soils in the map unit, and thus they do not affect use and management. These are called noncontrasting, or similar, components. They may or may not be mentioned in a particular map unit description. Other minor components, however, have properties and behavioral characteristics divergent enough to affect use or to require different management. These are called contrasting, or dissimilar, components. They generally are in small areas and could not be mapped separately because of the scale used. Some small areas of strongly contrasting soils or miscellaneous areas are identified by a special symbol on the maps. If included in the database for a given area, the contrasting minor components are identified in the map unit descriptions along with some characteristics of each. A few areas of minor components may not have been observed, and consequently they are not mentioned in the descriptions, especially where the pattern was so complex that it was impractical to make enough observations to identify all the soils and miscellaneous areas on the landscape.

The presence of minor components in a map unit in no way diminishes the usefulness or accuracy of the data. The objective of mapping is not to delineate pure taxonomic classes but rather to separate the landscape into landforms or

Custom Soil Resource Report

landform segments that have similar use and management requirements. The delineation of such segments on the map provides sufficient information for the development of resource plans. If intensive use of small areas is planned, however, onsite investigation is needed to define and locate the soils and miscellaneous areas.

An identifying symbol precedes the map unit name in the map unit descriptions. Each description includes general facts about the unit and gives important soil properties and qualities.

Soils that have profiles that are almost alike make up a *soil series*. Except for differences in texture of the surface layer, all the soils of a series have major horizons that are similar in composition, thickness, and arrangement.

Soils of one series can differ in texture of the surface layer, slope, stoniness, salinity, degree of erosion, and other characteristics that affect their use. On the basis of such differences, a soil series is divided into *soil phases*. Most of the areas shown on the detailed soil maps are phases of soil series. The name of a soil phase commonly indicates a feature that affects use or management. For example, Alpha silt loam, 0 to 2 percent slopes, is a phase of the Alpha series.

Some map units are made up of two or more major soils or miscellaneous areas. These map units are complexes, associations, or undifferentiated groups.

A *complex* consists of two or more soils or miscellaneous areas in such an intricate pattern or in such small areas that they cannot be shown separately on the maps. The pattern and proportion of the soils or miscellaneous areas are somewhat similar in all areas. Alpha-Beta complex, 0 to 6 percent slopes, is an example.

An *association* is made up of two or more geographically associated soils or miscellaneous areas that are shown as one unit on the maps. Because of present or anticipated uses of the map units in the survey area, it was not considered practical or necessary to map the soils or miscellaneous areas separately. The pattern and relative proportion of the soils or miscellaneous areas are somewhat similar. Alpha-Beta association, 0 to 2 percent slopes, is an example.

An *undifferentiated group* is made up of two or more soils or miscellaneous areas that could be mapped individually but are mapped as one unit because similar interpretations can be made for use and management. The pattern and proportion of the soils or miscellaneous areas in a mapped area are not uniform. An area can be made up of only one of the major soils or miscellaneous areas, or it can be made up of all of them. Alpha and Beta soils, 0 to 2 percent slopes, is an example.

Some surveys include *miscellaneous areas*. Such areas have little or no soil material and support little or no vegetation. Rock outcrop is an example.

Orange County, New York

ErB—Erie gravelly silt loam, 3 to 8 percent slopes

Map Unit Setting

National map unit symbol: 9vv9

Elevation: 100 to 1,390 feet

Mean annual precipitation: 42 to 52 inches

Mean annual air temperature: 46 to 52 degrees F

Frost-free period: 135 to 215 days

Farmland classification: Farmland of statewide importance

Map Unit Composition

Erie and similar soils: 80 percent

Minor components: 20 percent

Estimates are based on observations, descriptions, and transects of the mapunit.

Description of Erie

Setting

Landform: Till plains, drumlinoid ridges, hills

Landform position (two-dimensional): Footslope, summit

Landform position (three-dimensional): Base slope

Down-slope shape: Concave

Across-slope shape: Linear

Parent material: Loamy till derived from siltstone, sandstone, shale, and limestone

Typical profile

H1 - 0 to 9 inches: gravelly silt loam

H2 - 9 to 18 inches: channery silt loam

H3 - 18 to 54 inches: channery silt loam

H4 - 54 to 70 inches: channery silt loam

Properties and qualities

Slope: 3 to 8 percent

Depth to restrictive feature: 10 to 21 inches to fragipan

Drainage class: Somewhat poorly drained

Capacity of the most limiting layer to transmit water (Ksat): Moderately low to moderately high (0.06 to 0.20 in/hr)

Depth to water table: About 6 to 18 inches

Frequency of flooding: None

Frequency of ponding: None

Calcium carbonate, maximum content: 15 percent

Available water capacity: Very low (about 2.4 inches)

Interpretive groups

Land capability classification (irrigated): None specified

Land capability classification (nonirrigated): 3w

Hydrologic Soil Group: D

Ecological site: F144AY037MA - Moist Dense Till Uplands

Hydric soil rating: No

Minor Components

Bath

Percent of map unit: 5 percent

Custom Soil Resource Report

Hydric soil rating: No

Mardin

Percent of map unit: 5 percent

Hydric soil rating: No

Alden

Percent of map unit: 5 percent

Landform: Depressions

Hydric soil rating: Yes

Wurtsboro

Percent of map unit: 5 percent

Hydric soil rating: No

MdB—Mardin gravelly silt loam, 3 to 8 percent slopes

Map Unit Setting

National map unit symbol: 2v30j

Elevation: 330 to 2,460 feet

Mean annual precipitation: 31 to 70 inches

Mean annual air temperature: 39 to 52 degrees F

Frost-free period: 105 to 180 days

Farmland classification: Farmland of statewide importance

Map Unit Composition

Mardin and similar soils: 85 percent

Minor components: 15 percent

Estimates are based on observations, descriptions, and transects of the mapunit.

Description of Mardin

Setting

Landform: Hills, mountains

Landform position (two-dimensional): Summit, shoulder

Landform position (three-dimensional): Interfluve, side slope

Down-slope shape: Convex

Across-slope shape: Convex

Parent material: Loamy till

Typical profile

Ap - 0 to 8 inches: gravelly silt loam

Bw - 8 to 15 inches: gravelly silt loam

E - 15 to 20 inches: gravelly silt loam

Bx - 20 to 72 inches: gravelly silt loam

Properties and qualities

Slope: 3 to 8 percent

Surface area covered with cobbles, stones or boulders: 0.0 percent

Depth to restrictive feature: 14 to 26 inches to fragipan

Drainage class: Moderately well drained

Custom Soil Resource Report

Capacity of the most limiting layer to transmit water (Ksat): Very low to moderately low (0.00 to 0.14 in/hr)

Depth to water table: About 13 to 24 inches

Frequency of flooding: None

Frequency of ponding: None

Available water capacity: Low (about 3.6 inches)

Interpretive groups

Land capability classification (irrigated): None specified

Land capability classification (nonirrigated): 2w

Hydrologic Soil Group: D

Ecological site: F144AY008CT - Moist Till Uplands

Hydric soil rating: No

Minor Components

Volusia

Percent of map unit: 5 percent

Landform: Hills, mountains

Landform position (two-dimensional): Footslope, summit

Landform position (three-dimensional): Base slope, interflue, side slope

Down-slope shape: Concave

Across-slope shape: Linear

Hydric soil rating: No

Bath

Percent of map unit: 5 percent

Landform: Hills, mountains

Landform position (two-dimensional): Backslope, shoulder

Landform position (three-dimensional): Interflue, side slope

Down-slope shape: Concave

Across-slope shape: Linear

Hydric soil rating: No

Lordstown

Percent of map unit: 5 percent

Landform: Mountains, hills

Landform position (two-dimensional): Summit, shoulder

Landform position (three-dimensional): Mountaintop, interflue, crest

Down-slope shape: Convex

Across-slope shape: Convex

Hydric soil rating: No

MdC—Mardin gravelly silt loam, 8 to 15 percent slopes

Map Unit Setting

National map unit symbol: 2v30l

Elevation: 330 to 2,460 feet

Mean annual precipitation: 31 to 70 inches

Mean annual air temperature: 39 to 52 degrees F

Frost-free period: 105 to 180 days

Custom Soil Resource Report

Farmland classification: Farmland of statewide importance

Map Unit Composition

Mardin and similar soils: 85 percent

Minor components: 15 percent

Estimates are based on observations, descriptions, and transects of the mapunit.

Description of Mardin

Setting

Landform: Hills, mountains

Landform position (two-dimensional): Shoulder, backslope

Landform position (three-dimensional): Interfluvium, side slope

Down-slope shape: Linear

Across-slope shape: Linear

Parent material: Loamy till

Typical profile

Ap - 0 to 8 inches: gravelly silt loam

Bw - 8 to 15 inches: gravelly silt loam

E - 15 to 20 inches: gravelly silt loam

Bx - 20 to 72 inches: gravelly silt loam

Properties and qualities

Slope: 8 to 15 percent

Surface area covered with cobbles, stones or boulders: 0.0 percent

Depth to restrictive feature: 14 to 26 inches to fragipan

Drainage class: Moderately well drained

Capacity of the most limiting layer to transmit water (Ksat): Very low to moderately low (0.00 to 0.14 in/hr)

Depth to water table: About 13 to 24 inches

Frequency of flooding: None

Frequency of ponding: None

Available water capacity: Low (about 3.6 inches)

Interpretive groups

Land capability classification (irrigated): None specified

Land capability classification (nonirrigated): 3e

Hydrologic Soil Group: D

Ecological site: F144AY008CT - Moist Till Uplands

Hydric soil rating: No

Minor Components

Volusia

Percent of map unit: 5 percent

Landform: Hills, mountains

Landform position (two-dimensional): Footslope, summit

Landform position (three-dimensional): Base slope, interfluvium, side slope

Down-slope shape: Concave

Across-slope shape: Linear

Hydric soil rating: No

Lordstown

Percent of map unit: 5 percent

Landform: Mountains, hills

Landform position (two-dimensional): Backslope

Custom Soil Resource Report

Landform position (three-dimensional): Mountainflank, side slope, nose slope
Down-slope shape: Linear
Across-slope shape: Linear
Hydric soil rating: No

Bath

Percent of map unit: 5 percent
Landform: Hills, mountains
Landform position (two-dimensional): Backslope
Landform position (three-dimensional): Nose slope, side slope
Down-slope shape: Linear
Across-slope shape: Linear
Hydric soil rating: No

Soil Information for All Uses

Soil Properties and Qualities

The Soil Properties and Qualities section includes various soil properties and qualities displayed as thematic maps with a summary table for the soil map units in the selected area of interest. A single value or rating for each map unit is generated by aggregating the interpretive ratings of individual map unit components. This aggregation process is defined for each property or quality.

Soil Qualities and Features

Soil qualities are behavior and performance attributes that are not directly measured, but are inferred from observations of dynamic conditions and from soil properties. Example soil qualities include natural drainage, and frost action. Soil features are attributes that are not directly part of the soil. Example soil features include slope and depth to restrictive layer. These features can greatly impact the use and management of the soil.

Hydrologic Soil Group

Hydrologic soil groups are based on estimates of runoff potential. Soils are assigned to one of four groups according to the rate of water infiltration when the soils are not protected by vegetation, are thoroughly wet, and receive precipitation from long-duration storms.

The soils in the United States are assigned to four groups (A, B, C, and D) and three dual classes (A/D, B/D, and C/D). The groups are defined as follows:

Group A. Soils having a high infiltration rate (low runoff potential) when thoroughly wet. These consist mainly of deep, well drained to excessively drained sands or gravelly sands. These soils have a high rate of water transmission.

Group B. Soils having a moderate infiltration rate when thoroughly wet. These consist chiefly of moderately deep or deep, moderately well drained or well drained soils that have moderately fine texture to moderately coarse texture. These soils have a moderate rate of water transmission.

Custom Soil Resource Report

Group C. Soils having a slow infiltration rate when thoroughly wet. These consist chiefly of soils having a layer that impedes the downward movement of water or soils of moderately fine texture or fine texture. These soils have a slow rate of water transmission.

Group D. Soils having a very slow infiltration rate (high runoff potential) when thoroughly wet. These consist chiefly of clays that have a high shrink-swell potential, soils that have a high water table, soils that have a claypan or clay layer at or near the surface, and soils that are shallow over nearly impervious material. These soils have a very slow rate of water transmission.

If a soil is assigned to a dual hydrologic group (A/D, B/D, or C/D), the first letter is for drained areas and the second is for undrained areas. Only the soils that in their natural condition are in group D are assigned to dual classes.

Custom Soil Resource Report Map—Hydrologic Soil Group



Soil Map may not be valid at this scale.

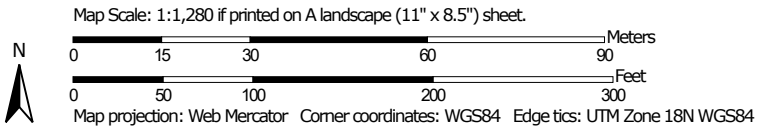

MAP LEGEND

Area of Interest (AOI)









 Area of Interest (AOI)

Soils

Soil Rating Polygons





-  A
-  A/D
-  B
-  B/D
-  C
-  C/D
-  D
-  Not rated or not available

Soil Rating Lines

-  A
-  A/D
-  B
-  B/D
-  C
-  C/D
-  D
-  Not rated or not available

Soil Rating Points





-  A
-  A/D
-  B
-  B/D

-  C
-  C/D
-  D
-  Not rated or not available

Water Features

 Streams and Canals

Transportation

-  Rails
-  Interstate Highways
-  US Routes
-  Major Roads
-  Local Roads

Background

 Aerial Photography

MAP INFORMATION

The soil surveys that comprise your AOI were mapped at 1:15,800.

Warning: Soil Map may not be valid at this scale.

Enlargement of maps beyond the scale of mapping can cause misunderstanding of the detail of mapping and accuracy of soil line placement. The maps do not show the small areas of contrasting soils that could have been shown at a more detailed scale.

Please rely on the bar scale on each map sheet for map measurements.

Source of Map: Natural Resources Conservation Service
 Web Soil Survey URL:
 Coordinate System: Web Mercator (EPSG:3857)

Maps from the Web Soil Survey are based on the Web Mercator projection, which preserves direction and shape but distorts distance and area. A projection that preserves area, such as the Albers equal-area conic projection, should be used if more accurate calculations of distance or area are required.

This product is generated from the USDA-NRCS certified data as of the version date(s) listed below.

Soil Survey Area: Orange County, New York
 Survey Area Data: Version 21, Jun 11, 2020

Soil map units are labeled (as space allows) for map scales 1:50,000 or larger.

Date(s) aerial images were photographed: Data not available.

The orthophoto or other base map on which the soil lines were compiled and digitized probably differs from the background imagery displayed on these maps. As a result, some minor shifting of map unit boundaries may be evident.

Table—Hydrologic Soil Group

Map unit symbol	Map unit name	Rating	Acres in AOI	Percent of AOI
ErB	Erie gravelly silt loam, 3 to 8 percent slopes	D	2.8	45.9%
MdB	Mardin gravelly silt loam, 3 to 8 percent slopes	D	0.4	6.3%
MdC	Mardin gravelly silt loam, 8 to 15 percent slopes	D	2.9	47.8%
Totals for Area of Interest			6.1	100.0%

Rating Options—Hydrologic Soil Group

Aggregation Method: Dominant Condition

Component Percent Cutoff: None Specified

Tie-break Rule: Higher

References

- American Association of State Highway and Transportation Officials (AASHTO). 2004. Standard specifications for transportation materials and methods of sampling and testing. 24th edition.
- American Society for Testing and Materials (ASTM). 2005. Standard classification of soils for engineering purposes. ASTM Standard D2487-00.
- Cowardin, L.M., V. Carter, F.C. Golet, and E.T. LaRoe. 1979. Classification of wetlands and deep-water habitats of the United States. U.S. Fish and Wildlife Service FWS/OBS-79/31.
- Federal Register. July 13, 1994. Changes in hydric soils of the United States.
- Federal Register. September 18, 2002. Hydric soils of the United States.
- Hurt, G.W., and L.M. Vasilas, editors. Version 6.0, 2006. Field indicators of hydric soils in the United States.
- National Research Council. 1995. Wetlands: Characteristics and boundaries.
- Soil Survey Division Staff. 1993. Soil survey manual. Soil Conservation Service. U.S. Department of Agriculture Handbook 18. http://www.nrcs.usda.gov/wps/portal/nrcs/detail/national/soils/?cid=nrcs142p2_054262
- Soil Survey Staff. 1999. Soil taxonomy: A basic system of soil classification for making and interpreting soil surveys. 2nd edition. Natural Resources Conservation Service, U.S. Department of Agriculture Handbook 436. http://www.nrcs.usda.gov/wps/portal/nrcs/detail/national/soils/?cid=nrcs142p2_053577
- Soil Survey Staff. 2010. Keys to soil taxonomy. 11th edition. U.S. Department of Agriculture, Natural Resources Conservation Service. http://www.nrcs.usda.gov/wps/portal/nrcs/detail/national/soils/?cid=nrcs142p2_053580
- Tiner, R.W., Jr. 1985. Wetlands of Delaware. U.S. Fish and Wildlife Service and Delaware Department of Natural Resources and Environmental Control, Wetlands Section.
- United States Army Corps of Engineers, Environmental Laboratory. 1987. Corps of Engineers wetlands delineation manual. Waterways Experiment Station Technical Report Y-87-1.
- United States Department of Agriculture, Natural Resources Conservation Service. National forestry manual. http://www.nrcs.usda.gov/wps/portal/nrcs/detail/soils/home/?cid=nrcs142p2_053374
- United States Department of Agriculture, Natural Resources Conservation Service. National range and pasture handbook. <http://www.nrcs.usda.gov/wps/portal/nrcs/detail/national/landuse/rangepasture/?cid=stelprdb1043084>

Custom Soil Resource Report

United States Department of Agriculture, Natural Resources Conservation Service. National soil survey handbook, title 430-VI. http://www.nrcs.usda.gov/wps/portal/nrcs/detail/soils/scientists/?cid=nrcs142p2_054242

United States Department of Agriculture, Natural Resources Conservation Service. 2006. Land resource regions and major land resource areas of the United States, the Caribbean, and the Pacific Basin. U.S. Department of Agriculture Handbook 296. http://www.nrcs.usda.gov/wps/portal/nrcs/detail/national/soils/?cid=nrcs142p2_053624

United States Department of Agriculture, Soil Conservation Service. 1961. Land capability classification. U.S. Department of Agriculture Handbook 210. http://www.nrcs.usda.gov/Internet/FSE_DOCUMENTS/nrcs142p2_052290.pdf

Appendix 9 | Construction Site Log Book

STATE POLLUTANT DISCHARGE ELIMINATION SYSTEM FOR CONSTRUCTION
ACTIVITIES

CONSTRUCTION SITE LOG BOOK

Table of Contents

- I. Pre-Construction Meeting Documents
 - a. Preamble to Site Assessment and Inspections
 - b. Operator's Certification
 - c. Qualified Professional's Credentials & Certification
 - d. Pre-Construction Site Assessment Checklist

- II. Construction Duration Inspections
 - a. Directions
 - b. Modification to the SWPPP

- III. Monthly Summary Reports

- IV. Monitoring, Reporting, and Three-Month Status Reports
 - a. Operator's Compliance Response Form

Properly completing forms such as those contained in Appendix H meet the inspection requirement of NYS-DEC SPDES GP for Construction Activities. Completed forms shall be kept on site at all times and made available to authorities upon request.

I. PRE-CONSTRUCTION MEETING DOCUMENTS

Project Name _____
Permit No. _____ Date of Authorization _____
Name of Operator _____
Prime Contractor _____

a. Preamble to Site Assessment and Inspections

The Following Information To Be Read By All Person's Involved in The Construction of Stormwater Related Activities:

The Operator agrees to have a qualified professional¹ conduct an assessment of the site prior to the commencement of construction² and certify in this inspection report that the appropriate erosion and sediment controls described in the SWPPP have been adequately installed or implemented to ensure overall preparedness of the site for the commencement of construction.

Prior to the commencement of construction, the Operator shall certify in this site logbook that the SWPPP has been prepared in accordance with the State's standards and meets all Federal, State and local erosion and sediment control requirements.

When construction starts, site inspections shall be conducted by the qualified professional at least every 7 calendar days and within 24 hours of the end of a storm event of 0.5 inches or greater (Construction Duration Inspections). The Operator shall maintain a record of all inspection reports in this site logbook. The site logbook shall be maintained on site and be made available to the permitting authorities upon request. The Operator shall post at the site, in a publicly accessible location, a summary of the site inspection activities on a monthly basis (Monthly Summary Report).

The operator shall also prepare a written summary of compliance with this general permit at a minimum frequency of every three months (Operator's Compliance Response Form), while coverage exists. The summary should address the status of achieving each component of the SWPPP.

Prior to filing the Notice of Termination or the end of permit term, the Operator shall have a qualified professional perform a final site inspection. The qualified professional shall certify that the site has undergone final stabilization³ using either vegetative or structural stabilization methods and that all temporary erosion and sediment controls (such as silt fencing) not needed for long-term erosion control have been removed. In addition, the Operator must identify and certify that all permanent structures described in the SWPPP have been constructed and provide the owner(s) with an operation and maintenance plan that ensures the structure(s) continuously functions as designed.

1 "Qualified Professional means a person knowledgeable in the principles and practice of erosion and sediment controls, such as a Certified Professional in Erosion and Sediment Control (CPESC), soil scientist, licensed engineer or someone working under the direction and supervision of a licensed engineer (person must have experience in the principles and practices of erosion and sediment control).

2 "Commencement of construction" means the initial removal of vegetation and disturbance of soils associated with clearing, grading or excavating activities or other construction activities.

3 "Final stabilization" means that all soil-disturbing activities at the site have been completed and a uniform, perennial vegetative cover with a density of eighty (80) percent has been established or equivalent stabilization measures (such as the use of mulches or geotextiles) have been employed on all unpaved areas and areas not covered by permanent structures.

b. Operators Certification

"I certify under penalty of law that this document and all attachments were prepared under my direction or supervision in accordance with a system designed to assure that qualified personnel properly gathered and evaluated the information submitted. Based on my inquiry of the person or persons who manage the system, or those persons directly responsible for gathering the information, the information submitted is, to the best of my knowledge and belief, true, accurate, and complete. Further, I hereby certify that the SWPPP meets all Federal, State, and local erosion and sediment control requirements. I am aware that false statements made herein are punishable as a class A misdemeanor pursuant to Section 210.45 of the Penal Law.

Name (please print): _____

Title _____ **Date:** _____

Address: _____

Phone: _____ **Email:** _____

Signature: _____

c. Qualified Professional's Credentials & Certification

"I hereby certify that I meet the criteria set forth in the General Permit to conduct site inspections for this project and that the appropriate erosion and sediment controls described in the SWPPP and as described in the following Pre-construction Site Assessment Checklist have been adequately installed or implemented, ensuring the overall preparedness of this site for the commencement of construction."

Name (please print): _____

Title _____ **Date:** _____

Address: _____

Phone: _____ **Email:** _____

Signature: _____

d. Pre-construction Site Assessment Checklist

(NOTE: Provide comments below as necessary)

1. Notice of Intent, SWPPP, and Contractors Certification:

Yes No NA

- Has a Notice of Intent been filed with the NYS Department of Conservation?
- Is the SWPPP on-site? Where? _____
- Is the Plan current? What is the latest revision date? _____
- Is a copy of the NOI (with brief description) onsite? Where? _____
- Have all contractors involved with stormwater related activities signed a contractor's certification?

2. Resource Protection

Yes No NA

- Are construction limits clearly flagged or fenced?
- Important trees and associated rooting zones, on-site septic system absorption fields, existing vegetated areas suitable for filter strips, especially in perimeter areas, have been flagged for protection.
- Creek crossings installed prior to land-disturbing activity, including clearing and blasting.

3. Surface Water Protection

Yes No NA

- Clean stormwater runoff has been diverted from areas to be disturbed.
- Bodies of water located either on site or in the vicinity of the site have been identified and protected.
- Appropriate practices to protect on-site or downstream surface water are installed.
- Are clearing and grading operations divided into areas <5 acres?

4. Stabilized Construction Entrance

Yes No NA

- A temporary construction entrance to capture mud and debris from construction vehicles before they enter the public highway has been installed.
- Other access areas (entrances, construction routes, equipment parking areas) are stabilized immediately as work takes place with gravel or other cover.
- Sediment tracked onto public streets is removed or cleaned on a regular basis.

5. Perimeter Sediment Controls

Yes No NA

- Silt fence material and installation comply with the standard drawing and specifications.
- Silt fences are installed at appropriate spacing intervals
- Sediment/detention basin was installed as first land disturbing activity.
- Sediment traps and barriers are installed.

6. Pollution Prevention for Waste and Hazardous Materials

Yes No NA

- The Operator or designated representative has been assigned to implement the spill prevention avoidance and response plan.
- The plan is contained in the SWPPP on page _____
- Appropriate materials to control spills are onsite. Where? _____

II. CONSTRUCTION DURATION INSPECTIONS

a. Directions:

Inspection Forms will be filled out during the entire construction phase of the project.

Required Elements:

- (1) On a site map, indicate the extent of all disturbed site areas and drainage pathways. Indicate site areas that are expected to undergo initial disturbance or significant site work within the next 14-day period;
- (2) Indicate on a site map all areas of the site that have undergone temporary or permanent stabilization;
- (3) Indicate all disturbed site areas that have not undergone active site work during the previous 14-day period;
- (4) Inspect all sediment control practices and record the approximate degree of sediment accumulation as a percentage of sediment storage volume (for example, 10 percent, 20 percent, 50 percent);
- (5) Inspect all erosion and sediment control practices and record all maintenance requirements such as verifying the integrity of barrier or diversion systems (earthen berms or silt fencing) and containment systems (sediment basins and sediment traps). Identify any evidence of rill or gully erosion occurring on slopes and any loss of stabilizing vegetation or seeding/mulching. Document any excessive deposition of sediment or ponding water along barrier or diversion systems. Record the depth of sediment within containment structures, any erosion near outlet and overflow structures, and verify the ability of rock filters around perforated riser pipes to pass water; and
- (6) Immediately report to the Operator any deficiencies that are identified with the implementation of the SWPPP.

SITE PLAN/SKETCH

Inspector (print name)

Date of Inspection

Qualified Professional (print name)

Qualified Professional Signature

The above signed acknowledges that, to the best of his/her knowledge, all information provided on the forms is accurate and complete.

Maintaining Water Quality

Yes No NA

- Is there an increase in turbidity causing a substantial visible contrast to natural conditions?
- Is there residue from oil and floating substances, visible oil film, or globules or grease?
- All disturbance is within the limits of the approved plans.
- Have receiving lake/bay, stream, and/or wetland been impacted by silt from project?

Housekeeping

1. General Site Conditions

Yes No NA

- Is construction site litter and debris appropriately managed?
- Are facilities and equipment necessary for implementation of erosion and sediment control in working order and/or properly maintained?
- Is construction impacting the adjacent property?
- Is dust adequately controlled?

2. Temporary Stream Crossing

Yes No NA

- Maximum diameter pipes necessary to span creek without dredging are installed.
- Installed non-woven geotextile fabric beneath approaches.
- Is fill composed of aggregate (no earth or soil)?
- Rock on approaches is clean enough to remove mud from vehicles & prevent sediment from entering stream during high flow.

Runoff Control Practices

1. Excavation Dewatering

Yes No NA

- Upstream and downstream berms (sandbags, inflatable dams, etc.) are installed per plan.
- Clean water from upstream pool is being pumped to the downstream pool.
- Sediment laden water from work area is being discharged to a silt-trapping device.
- Constructed upstream berm with one-foot minimum freeboard.

2. Level Spreader

Yes No NA

- Installed per plan.
- Constructed on undisturbed soil, not on fill, receiving only clear, non-sediment laden flow.
- Flow sheets out of level spreader without erosion on downstream edge.

3. Interceptor Dikes and Swales

Yes No NA

- Installed per plan with minimum side slopes 2H:1V or flatter.
- Stabilized by geotextile fabric, seed, or mulch with no erosion occurring.
- Sediment-laden runoff directed to sediment trapping structure

Runoff Control Practices (continued)

4. Stone Check Dam

Yes No NA

- Is channel stable? (flow is not eroding soil underneath or around the structure).
- Check is in good condition (rocks in place and no permanent pools behind the structure).
- Has accumulated sediment been removed?.

5. Rock Outlet Protection

Yes No NA

- Installed per plan.
- Installed concurrently with pipe installation.

Soil Stabilization

1. Topsoil and Spoil Stockpiles

Yes No NA

- Stockpiles are stabilized with vegetation and/or mulch.
- Sediment control is installed at the toe of the slope.

2. Revegetation

Yes No NA

- Temporary seedings and mulch have been applied to idle areas.
- 4 inches minimum of topsoil has been applied under permanent seedings

Sediment Control Practices

1. Stabilized Construction Entrance

Yes No NA

- Stone is clean enough to effectively remove mud from vehicles.
- Installed per standards and specifications?
- Does all traffic use the stabilized entrance to enter and leave site?
- Is adequate drainage provided to prevent ponding at entrance?

2. Silt Fence

Yes No NA

- Installed on Contour, 10 feet from toe of slope (not across conveyance channels).
 - Joints constructed by wrapping the two ends together for continuous support.
 - Fabric buried 6 inches minimum.
 - Posts are stable, fabric is tight and without rips or frayed areas.
- Sediment accumulation is ____% of design capacity.

Sediment Control Practices (continued)**3. Storm Drain Inlet Protection (Use for Stone & Block; Filter Fabric; Curb; or, Excavated practices)****Yes No NA**

- Installed concrete blocks lengthwise so open ends face outward, not upward.
- Placed wire screen between No. 3 crushed stone and concrete blocks.
- Drainage area is 1 acre or less.
- Excavated area is 900 cubic feet.
- Excavated side slopes should be 2:1.
- 2" x 4" frame is constructed and structurally sound.
- Posts 3-foot maximum spacing between posts.
- Fabric is embedded 1 to 1.5 feet below ground and secured to frame/posts with staples at max 8-inch spacing.
- Posts are stable, fabric is tight and without rips or frayed areas.
- Sediment accumulation ___% of design capacity.

4. Temporary Sediment Trap**Yes No NA**

- Outlet structure is constructed per the approved plan or drawing.
- Geotextile fabric has been placed beneath rock fill.
- Sediment accumulation is ___% of design capacity.

5. Temporary Sediment Basin**Yes No NA**

- Basin and outlet structure constructed per the approved plan.
- Basin side slopes are stabilized with seed/mulch.
- Drainage structure flushed and basin surface restored upon removal of sediment basin facility.
- Sediment accumulation is ___% of design capacity.

Note: Not all erosion and sediment control practices are included in this listing. Add additional pages to this list as required by site specific design.

Construction inspection checklists for post-development stormwater management practices can be found in Appendix F of the New York Stormwater Management Design Manual.

Appendix 10 | NYSDEC Construction Stormwater Inspection Manual

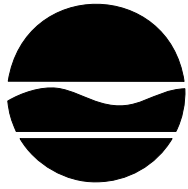

**NEW YORK STATE DEPARTMENT OF
ENVIRONMENTAL CONSERVATION**

Construction Stormwater Inspection Manual
**Primarily for Government Inspectors Evaluating Compliance with Construction
Stormwater Control Requirements**

**New York State
Department of Environmental Conservation**

TABLE OF CONTENTS

Version 1.05 (8/27/07)

<u>Section</u>	<u>Content</u>	<u>Page</u>
1.0	INTRODUCTION AND PURPOSE	1
1.1	Compliance Inspections	1
1.2	Self-inspections	2
2.0	PRE-INSPECTION ACTIVITIES	3
2.1	Regulatory Oversight Authorities	3
2.2	Permittee's Self-inspector	5
3.0	ON-SITE INSPECTION ACTIVITIES	5
3.1	Compliance Inspections	5
3.2	Non-permitted Site Inspections	9
3.3	Self-inspections	9
4.0	POST-INSPECTION ACTIVITIES	10
4.1	Regulatory Oversight Authorities	10
4.2	Permittee's Self-inspections	11

ATTACHMENTS

Attachment 1 - Compliance Inspection Form	12
Attachment 2 - Unpermitted Site Notice	14
Attachment 3 - Example Inspection Letter	15

1.0 INTRODUCTION AND PURPOSE

The New York State Department of Environmental Conservation Division of Water (DOW) considers there to be two types of inspections germane to construction stormwater; compliance inspections and self-inspections.

This manual is for use by DOW and other regulatory oversight construction stormwater inspectors in performing compliance inspections, as well as for site operators in performing self inspections. The manual should be used in conjunction with the *New York State Standards and Specifications for Erosion and Sediment Control*, August 2005.

1.1 Compliance Inspections

Regulatory compliance inspections are performed by regulatory oversight authorities such as DOW staff, or representatives of DOW and local municipal construction stormwater inspectors. These inspections are intended to determine compliance with the state or local requirements for control of construction stormwater through erosion and sediment control and post construction practices. Compliance inspections focus on determinations of compliance with legal and water quality standards. Typically, compliance inspections can be further sub-categorized to include comprehensive inspections, and follow-up or reconnaissance inspections.

Compliance inspectors will focus on determining whether:

- the project is causing water quality standard violations;
- the required Stormwater Pollution Prevention Plan (SWPPP) includes appropriate erosion and sediment controls and, to some extent, post construction controls;
- the owner/operator is complying with the SWPPP;
- where required, self-inspections are being properly performed; and
- where self-inspections are required, the owner/operator responds appropriately to the self-inspector's reports.

1.1.1 Comprehensive Inspection

Comprehensive inspections are designed to verify permittee compliance with all applicable regulatory requirements, effluent controls, and compliance schedules. This inspection involves records reviews, visual observations, and evaluations of management practices, effluents, and receiving waters.

Comprehensive inspections should be conducted according to a neutral or random inspection scheme, or in accordance with established priorities. A neutral monitoring scheme provides some objective basis for scheduling inspections and sampling visits by establishing a system (whether complex factor-based, alphabetic, or geographic) for setting priorities to ensure that a particular facility is not unfairly selected for inspection or sampling. The selection of which

facility to inspect must be made without bias to ensure that the regulatory oversight authority, if challenged for being arbitrary and capricious manner, can reasonably defend itself.

A neutral inspection scheme should set the criteria the inspector uses to choose which facilities to inspect, but the schedule for the actual inspection should remain confidential, and may be kept separate from the neutral plan.

A routine comprehensive compliance inspection is most effective when it is unannounced or conducted with very little advance warning.

1.1.2 Reconnaissance Inspection

A reconnaissance inspection is performed in lieu of, or following a comprehensive inspection to obtain a preliminary overview of an owner/operator's compliance program, to respond to a citizen complaint, or to assess a non-permitted site. The inspector performs a brief (generally about an hour) visual inspection of the site, discharges and receiving waters. A reconnaissance inspection uses the inspector's experience and judgement to summarize potential compliance problems, without conducting a full comprehensive inspection. The objective of a reconnaissance inspection is to expand inspection coverage without increasing inspection resource expenditures. The reconnaissance inspection is the shortest and least resource intensive of all inspections.

Reconnaissance inspections may be initiated in response to known or suspected violations, a public complaint, a violation of regulatory requirements, or as follow-up to verify that necessary actions were taken in response to a previous inspection.

1.2 Self-inspections

For some projects, the site owner/operator is required by their State Pollutant Discharge Elimination System (SPDES) Permit and/or local requirements to have a qualified professional¹ perform a "self-inspection" at the site. In self-inspections, the qualified professional determines whether the site is being managed in accordance with the SWPPP, and whether the SWPPP's recommended erosion and sediment controls are effective. If activities are not in accordance with the SWPPP, or if the SWPPP erosion and sediment controls are not effective, the qualified professional inspecting the site recommends corrections to the owner/operator.

¹ A "Qualified professional" is a person knowledgeable in the principles and practice of erosion and sediment controls, such as a licensed professional engineer, Certified Professional in Erosion and Sediment Control (CPESC), licensed landscape architect or soil scientist.

2.0 PRE-INSPECTION ACTIVITIES

2.1 Regulatory Oversight Authorities

This section is intended for inspectors with regulatory oversight authority such as agents of the DOW or a local municipality, or others acting on their behalf, such as county Soil and Water Conservation District staff. Examples of other regulatory oversight authorities include: the United States Environmental Protection Agency (EPA); New York City Department of Environmental Protection (DEP), Adirondack Park Agency (APA); the Lake George Park Commission (LGPC), and the Skaneateles Lake Watershed Authority (SLWA). Before arriving on-site to conduct the inspection, considerations concerning communication, documentation and equipment must be made.

Regulatory oversight authority is granted by state or local law to government agencies or, depending upon the particular law, an authorized representative of state or local government. SPDES rules 6 NYCRR 750-2.3 and Environmental Conservation Law 17-0303(6) and 17-0829(a) all allow for authorized representatives of the (NYSDEC) commissioner to perform all the duties of an inspector.

2.1.1 Communication

Coordination with Other Entities

Where appropriate, prior to selecting sites for inspection, compliance inspectors should communicate with other regulatory oversight authorities to avoid unnecessary duplication or to coordinate follow-up to inspections performed by other regulatory oversight authorities.

Announced vs. Unannounced Inspection

Inspections may be announced or unannounced. Each method has its own advantages and disadvantages. Unannounced inspections are preferred, however many job sites are not continuously manned, or not always staffed by someone who is familiar with the SWPPP, thus necessitating an announced inspection. As an alternative, when an announced inspection is necessary, inspectors should try to give as little advanced warning as possible (24 hours is suggested).

Itinerary

For obvious safety reasons, inspectors should be sure to inform someone in their office which site or sites they will be visiting prior to leaving the to perform inspections.

2.1.2 Documentation

Data Review

The inspector should review any available information such as:

- Notice of Intent
- Stormwater Pollution Prevention Plan
- Past inspection records
- Phasing plan

- Construction sequence
- Inspection and Maintenance schedules
- Site specific issues
- Consent Orders
- Access agreements

Inspection Form

The inspector should have copies of, and be familiar with, the inspection form used by their regulatory oversight authority (example in Attachment 1) before leaving the office. Static information such as name, location and permit number can be entered onto the inspection form prior to arriving at the inspection site.

Credentials

Inspectors should always carry proper identification to prove that they are employed by an entity with jurisdictional authority. Failure to display proper credentials may be legal grounds for denial of entry to a site.

2.1.3 Equipment

Personal Protective Equipment

DOW employees must conform to the DOW Health and Safety policy as it relates to personal protective equipment. Other regulatory oversight authorities should have their own safety policies or, if not, may wish to consult the OSHA health and safety tool at: www.osha.gov/dep/etools/ehasp/ to develop a health and safety plan.

The following is a list of some of the most common health and safety gear that may be needed:

- Hard hat (Class G, Type I or better)
- Safety toe shoes
- Reflective vest
- Hearing protection (to achieve 85 dBA - 8 hr TWA)
- Safety glasses with side shields

If the construction is on an industrial site or a hazardous waste site, special training may be required prior to entering the site. The inspector should consult with OSHA or NYSDEC prior to entering such a site.

Monitoring Equipment

The following is a list of some equipment that may be helpful to document facts and verify compliance:

- Digital Camera
- Measuring tape or wheel
- Hand level or clinometer
- Turbidity meter (in limited circumstances)

2.2 Permittee's Self-inspection

This section is intended for qualified professionals who conduct site self-inspections on behalf of owner/operators. Self-inspectors are responsible for performing inspections in accordance with permit requirements and reporting to site owners and operators the results and any recommendations resulting from the inspection.

Prior to conducting inspections, qualified professionals should ensure familiarity with the Stormwater Pollution Prevention Plan and previous inspection reports.

3.0 ON-SITE INSPECTION PROCESS

3.1 Compliance Inspections

3.1.1 Professionalism

Don't Pretend to Possess Knowledge

Unless the inspector has experience with a particular management practice, do not pretend to possess knowledge. Inspectors cannot be expert in all areas; their job is to collect information, not to demonstrate superior wisdom. Site operators are often willing to talk to someone who is inquisitive and interested. Within reason, asking questions to obtain new information about a management practice, construction technique or piece of equipment is one of the inspector's main roles in an inspection.

Don't Recommend Solutions

The inspector should not recommend solutions or endorse products. The solution to a compliance problem may appear obvious based on the inspector's experience. However, the responsibility should be placed on the site owner to implement a workable solution to a compliance problem that meets NYSDEC standards. The inspector should refer the site operator to the New York Standards and Specifications for Erosion and Sediment Control (the Blue Book) or the New York State Stormwater Management Design Manual (the Design Manual).

Key advice must be offered carefully. One experienced stormwater inspector suggests saying: "I can't direct you or make recommendations, but what we've seen work in other situations is ..."

The way inspectors present themselves is important to the effectiveness of the inspection. An inspector cannot be overly familiar, but will be more effective if able to establish a minimum level of communication.

3.1.2 Safety

DOW employees must conform to Division health and safety policies when on a construction site. Other regulatory oversight authorities should have their own safety policies or, if not, may

wish to consult the OSHA health and safety tool at:

www.osha.gov/dep/etools/ehasp to develop a health and safety plan.

Some general protections for construction sites are:

- Beware of heavy equipment, avoid operator blind spots and make sure of operator eye contact around heavy equipment.
- Avoid walking on rock rip-rap if possible. Loose rock presents a slip hazard.
- Stay out of confined spaces like tanks, trenches and foundation holes.
- Avoid lightning danger. Monitor weather conditions, get out of water, avoid open areas and high points, do not huddle in groups or near trees.
- Protect yourself from sun and heat exposure. Use sun screen or shading clothing. Remain hydrated by drinking water, watching for signs of heat cramps, exhaustion (fatigue, nausea, dizziness, headache, cool or moist skin), or stroke (high body temperature; red, hot and dry skin)
- Protect yourself from cold weather. Wear multiple layers of thin clothing. Wear a warm hat. Drink warm fluids or eat hot foods, and keep dry.
- Avoid scaffolding in excess of 4 feet above grade.
- Beware of ticks, stinging insects, snakes and poison ivy or sumac.

3.1.3 Legal access

DOW has general powers, set forth under ECL 17-0303, subparagraph 6, to enter premises for inspections. In addition, ECL 3-0301.2 conveys general statutory authority granting the DOW the power to access private property to fulfill DOW obligations under the law.

ECL 15-0305 gives the DOW the authority to enter at all times in or upon any property, public or private, for the purpose of inspecting or investigating conditions affecting the construction of improvements to or developments of water resources for the public health, safety or welfare.

ECL 17-0829 allows an authorized DOW representative, upon presentation of their credentials, to enter upon any premises where any effluent source is located, or in which records are required to be maintained. The representative may at reasonable times have access to, and sample discharges/pollutants to the waters or to publicly owned treatment plants where the effluent source is located. This subparagraph provides DOW representatives performing their duties authority to enter a site to pursue administrative violations. Pursuing criminal violations may require a warrant or the owner's permission to enter the site.

For sites that are permitted, DOW has authority under the permit to enter the site.

If the owner/operator's representatives onsite deny access, the inspector *should not* physically force entry. Under these circumstances the attorney representing the inspector should be immediately notified and consideration should be given to soliciting the aid of a law officer to obtain entry.

DOW staff have the right to enter at any reasonable time. If no one is available, and the site is fenced or posted, DOW staff should make all reasonable efforts to identify, contact and notify the owner that the DOW is entering the site. If the inspector has made all reasonable efforts to contact site owners, but was unable to do so, the site can then be accessed. All efforts should be taken not to cause any damage to the facility.

Other regulatory oversight authorities should seek advice on their legal authorities to enter a job site. Municipalities that have adopted Article 6 of the New York State Sample Local Law for Stormwater Management and Erosion and Sediment Control (NYSDEC, 2004, updated 2006) will have legal authority to enter sites in accordance with that chapter and any other existing municipal authority .

Agents of DOW have authority similar DOW staff authority to enter sites. However, DOW staff enjoy significant personal liability protections as state employees. That liability protection may not be the same for authorized representatives of DOW. For authorized representatives of DOW (or other regulatory oversight authorities), it is prudent to obtain permission to enter the site. If such permission is denied, the authorized representatives should inform the appropriate DOW contact, usually the regional water manager.

3.1.4 Find the Legally Responsible Party (Construction Manager, Self-inspector)

The first action a compliance inspector should take upon entering a construction site is to find the construction trailer or the construction or project manager if they are available. The inspector should present appropriate identification to the site's responsible party and state the reason for the inspection; construction stormwater complaint response or neutral construction stormwater inspection. If the inspection is initiated as a response to a complaint, frequently the responsible party will ask who made the complaint. DOW keeps private individual complainants confidential. If the complainant is another regulatory oversight authority, DOW tends to make that known to the site's responsible party.

3.1.5 On-site records review (NOI, SWPPP, Self-inspection Reports, Permit)

Generally, the compliance inspector should next review the on-site records. Verify that a copy of the construction stormwater permit and NOI are on-site. Verify that the acreage, site conditions, and receiving water listed on the NOI are accurate. Compare the on-site documentation with documentation already submitted to, or obtained by the compliance inspector.

If the SWPPP has not been reviewed in the office, verify that it exists and contains the minimum required components (16 for a basic plan and 22 for a full plan). On-site review of the SWPPP should determine if: there is an appropriate phasing plan; the acreage disturbed in each phase, construction sequence for each phase; proposed implementation of erosion and sediment control measures; and, where required, post construction controls. For each of the erosion and sediment control practices, the SWPPP must show design details in accordance with the NYS Standards for Erosion and Sediment Controls. The SWPPP must also include provisions for maintenance of practices during construction. On-site review of post construction controls is generally limited to verification that the proposed stormwater management practices are shown on the site plan.

Where self-inspections are required, self-inspection reports are a significant tool for the compliance inspector to determine the performance history of the site. The self-inspection reports should be done with the required frequency. Self-inspection reports must include all the details required by the permit. Generally, it is desirable for permit information to be shown on a site plan. The compliance inspector should become familiar with the report and use that familiarity to judge whether the self-inspections are being performed correctly and that the site operator is correcting deficiencies noted in the report.

3.1.6 Walk the Site

During wet weather conditions, it may be advantageous to observe the receiving waters prior to walking the rest of the site. At some point during the inspection, the receiving water conditions must be observed and noted. It is critical to note if there is a substantial visible contrast to natural conditions, or evidence of deposition, streambank erosion, construction debris or waste materials (e.g. concrete washdown) in the receiving stream.

Each inspector should evaluate actual implementation and maintenance of practices on-site compared to how implementation and maintenance is detailed in the SWPPP. At a minimum, the compliance inspector should observe all areas of active construction. Observing equipment or materials storage, recently stabilized areas, or stockpile areas is also appropriate to evaluate the effectiveness of management practices.

3.1.7 Taking Photographs

Evidence of poor receiving water conditions and poor or ineffective practices should be documented with digital photographs. Those photographs should be logged date stamped and stored on media that cannot be edited (e.g. write only CDs). Photos should also be appended to the site inspector's report.

It is also beneficial to take photographs of good practices for educational and technology transfer reasons.

3.1.8 Exit Interview

Clearly communicate expectations and consequences. If it is clear from the inspection that the owner/operator must modify the SWPPP, or modify management practices within an assigned period (e.g. 24 hours, 48 hours, one week, two weeks), then that finding should be communicated at the time of the exit interview. The inspector should assign the period based on factors such as how long it would reasonably take to complete such modifications and the level of risk to water quality associated with failure to make such modifications.

The inspector should make clear that NYSDEC reserves rights to future enforcement actions. If the inspector's supervisor or enforcement coordinator determines additional enforcement actions are necessary, the inspector *should not* reassure the owner/operator that the current situation is acceptable.

3.2 Non-permitted Site Inspections

For sites not authorized in accordance with state or local laws, the process will be abbreviated. First verify the need for authorization and observe receiving waters to detect water quality standard violations. If there is a violation, notify the owner of the violation or other compliance actions in response to their illicit activity. For DOW staff, Attachment 2 or a similar notice can be used to notify the site owner/operator that stormwater authorization is required.

3.3 Self-inspections

The role of the self-inspector is to verify that the site is complying with stormwater requirements. In particular, the self-inspector verifies that the SWPPP is being properly implemented. The self-inspector also documents SWPPP implementation so regulatory agencies can review implementation activities.

It is not the role of the self-inspector to report directly to regulatory authorities.

Appendix H of *The New York Standards and Specifications for Erosion and Sediment Control* - August 2005 (the Blue Book) includes a Construction Duration Inspection checklist that can be used by the owner/operators qualified professional for self-inspections. The Blue Book is available on the NYSDEC website.

3.3.1 Purpose

The self inspector should ensure that the project's SWPPP is being properly implemented. This includes ensuring that the erosion and sediment control practices are properly installed and being maintained in accordance with the SWPPP/Blue Book.

The project must be properly phased to limit the disturbance to less than five acres, and the construction sequence for each phase must be followed. The SWPPP must also be modified to address evolving circumstances. Finally, and most importantly, receiving waters must be protected.

If a soil disturbance will be greater than five acres at any given time, the site operator must obtain written permission from the DOW regional office.

3.3.2 Pre-construction Conference

The parties responsible for various aspects of stormwater compliance should be identified at the pre-construction conference. Responsible parties may include, but are not limited to, owner's engineer, owner/operator/permittee, contractors, and subcontractors.

Typical responsibilities include: installation of erosion and sediment control (E & SC) practices; maintenance of E & SC practices, inspection of E&SC practices, installation of post construction stormwater management practices (SMPs), inspection of post construction SMPs, SWPPP revisions, and contractor direction.

All parties should clearly know what is expected of them. Responsible parties should complete the Pre-construction Site Assessment Checklist provided in Appendix H of the Blue Book.

3.3.3 Inspection Preparation

The inspector should review the project's SWPPP (including the phasing plan, construction sequence and site specific issues) and the last few inspection reports (if the inspector has them available).

3.3.4 Self-inspection Components

Inspect installation, performance and maintenance of all E&SC practices

The self inspector should inspect all areas that are under active construction or disturbance and areas that are vulnerable to erosion. The self-inspector should also inspect areas that will be disturbed prior to the next inspection for measures required prior to construction (e.g. silt barriers, stabilized construction entrance, diversions). Finally, self-inspectors should inspect post-construction controls during and after installation.

Identify site deficiencies and corrective measures

The self-inspector's reports must be maintained in a log book on site and the log book must be made available to the regulatory authorities. Although the legal responsibility for filing a Notice of Termination lies with the owner/operator, the self-inspector may also be called upon to perform a final site inspection, including post construction SMPs, prior to filing the Notice of Termination.

4.0 POST-INSPECTION ACTIVITIES

4.1 Regulatory Oversight Authorities

This section is intended for inspectors with regulatory oversight authority such as agents of the DOW or a local municipality, or others acting on their behalf (such as County Soil and Water Conservation District staff.) Upon completion of an inspection, inspection results should be documented for the record.

4.1.1 Written Notification

The inspector should inform the permittee or the on-site representative of their inspection results in writing by sending the permittee a complete, signed copy of the inspection report. The inspection report should be transmitted under a cover letter which elaborates on any deficiencies noted in the inspection report. It is not a good idea to commend exceptional efforts by the owner/operator in a letter, because such letters tend to undermine enforcement efforts when compliance status at a site degrades.

The inspector should consider providing a copy of the cover letter and inspection report to other parties with including:

- Permittee
- Contractor(s)
- Other regulatory oversight authorities
- Other parties present during the inspection (e.g. SWPPP preparer, permittee's self-inspector, etc.)

For DOW staff, an example of the inspection cover letter is included as Attachment 3.

4.1.2 Inspection Tracking

DOW staff must enter their inspection results into the electronic *Water Compliance System*.

Local municipalities and other regulatory oversight authorities are encouraged to develop an electronic tracking system in which to record their inspections.

4.2 Permittee's Self-inspections

This section is intended for qualified professionals who conduct site inspections for permittees in accordance with a SPDES permit or local requirements.

4.2.1 Written Records

Inspection Reports

The inspector shall prepare a written report summarizing inspection results. The inspection report is then provided to the permittee, or the permittee's duly authorized representative, and to the contractor responsible for implementing stormwater controls on-site in order to correct deficiencies noted in the inspection report. Finally, the inspection report must be added to the site log book that is required to be maintained on-site, and be available to regulatory oversight authorities for review.

4.2.2 Stormwater Pollution Prevention Plan Revisions

The inspector must inform the permittee of his/her duty to amend the Stormwater Pollution Prevention Plan (SWPPP) whenever an inspection proves the SWPPP to be ineffective in:

- Eliminating or significantly minimizing pollutants from on-site sources
- Achieving the general objectives of controlling pollutants in stormwater discharges from permitted construction activity
- Eliminating discharges that cause a substantial visible contrast to natural conditions

ATTACHMENT 1
Construction Stormwater Compliance Inspection Report

Project Name and Location: Municipality: County:	Date:	Page 1 of 2
	Permit # (if any): NYR	
	Entry Time:	Exit Time:
On-site Representative(s) and contact information:		Weather Conditions:
Name and Address of SPDES Permittee/Title/Phone/Fax Numbers: Contacted: Yes <input type="checkbox"/> No <input type="checkbox"/>		

INSPECTION CHECKLIST

SPDES Authority

Yes No N/A

1. Is a copy of the NOI posted at the construction site for public viewing?
2. Is an up-to-date copy of the signed SWPPP retained at the construction site?
3. Is a copy of the SPDES General Permit retained at the construction site?

Law, rule or permit citation

SWPPP Content

Yes No N/A

4. Does the SWPPP describe and identify the erosion & sediment control measures to be employed?
5. Does the SWPPP provide a maintenance schedule for the erosion & sediment control measures?
6. Does the SWPPP describe and identify the post-construction SW control measures to be employed?
7. Does the SWPPP identify the contractor(s) and subcontractor(s) responsible for each measure?
8. Does the SWPPP include all the necessary 'CONTRACTOR CERTIFICATION' statements?
9. Is the SWPPP signed/certified by the permittee?

Law, rule or permit citation

Recordkeeping

Yes No N/A

10. Are inspections performed as required by the permit (every 7 days and after 1/2" rain event)?
11. Are the site inspections performed by a qualified professional?
12. Are all required reports properly signed/certified?
13. Does the SWPPP include copies of the monthly/quarterly written summaries of compliance status?

Law, rule or permit citation

Visual Observations

Yes No N/A

14. Are all erosion and sediment control measures installed/constructed?
15. Are all erosion and sediment control measures maintained properly?
16. Have all disturbances of 5 acres or more been approved prior to the disturbance?
17. Are stabilization measures initiated in inactive areas?
18. Are permanent stormwater control measures implemented?
19. Was there a discharge into the receiving water on the day of inspection?
20. Are receiving waters free of there evidence of turbidity, sedimentation, or oil ? (If no , complete Page 2)

Law, rule or permit citation

Overall Inspection Rating: <input type="checkbox"/> Satisfactory <input type="checkbox"/> Marginal <input type="checkbox"/> Unsatisfactory	
Name/Agency of Lead Inspector:	Signature of Lead Inspector:
Names/Agencies of Other Inspectors:	

Water Quality Observations

Describe the discharge(s) [source(s), impact on receiving water(s), etc.] _____

Describe the quality of the receiving water(s) both upstream and downstream of the discharge _____

Describe any other water quality standards or permit violations _____

Additional Comments: _____

Photographs attached

ATTACHMENT 2

**** NOTICE ****

On March 10, 2003, provisions of the Federal Clean Water Act went into effect that apply to many construction operations.

If your construction operations result in the disturbance of one acre or greater and stormwater runoff from your site reaches surface waters (i.e., lake, stream, road side ditch, swale, storm sewer system, etc.), the stormwater runoff from your site must be covered by a State Pollutant Discharge Elimination System (SPDES) Permit issued by the New York State Department of Environmental Conservation (NYSDEC).

To facilitate your compliance with the law, NYSDEC has issued a General Permit which may be applicable to your project. To obtain coverage under this General Permit, you need to prepare a Stormwater Pollution Prevention Plan (SWPPP) and then file a Notice of Intent (NOI) to the NYSDEC headquarters in Albany. The NOI form is available on the DEC website. You may also obtain a copy of the NOI form at the nearest NYSDEC regional offices.

When you file your NOI you are certifying that you have developed a SWPPP and that it will be implemented prior to commencing construction. When you submit the NOI you need to indicate if your SWPPP is in conformance with published NYSDEC technical standards; if it is, your SPDES permit coverage will be effective in as few as five business days. If your SWPPP does not conform to the DEC technical standards, coverage will not be available for at least 60 business days.

Failure to have the required permit can result in legal actions which include Stop Work Orders and/or monetary penalties of up to \$37,500/day

If your construction operations are already in progress and you are not covered by an appropriate NYSDEC permit contact the NYSDEC Regional Water Engineer as soon as possible. If your construction field operations have not yet commenced, review the NOI and the General Permit on the DEC's website or at the DEC regional office for your area. When you are comfortable that you understand and comply with the requirements, file your NOI.

The requirement to file an NOI does not replace any local requirements. Developers/Contractors are directed to contact the Local Code Enforcement Officer or Stormwater Management Officer for local requirements.

ATTACHMENT 3

<< Date >>

Mr. John Smith
123 Main Street
Ferracane, NY 12345

**Re: Stormwater Inspection
SPDES Permit Identification No. NYR10Z000 (through SPDES No. GP-02-01)
Blowing Leaves Subdivision
Gasper (T), Eaton (Co.)**

Dear Mr. Smith:

On the afternoon of << date >> I conducted an inspection of the construction activities associated with the Blowing Leaves Subdivision located on County Route 1 in the town of Gasper, Eaton County. The inspection was conducted in the presence of you and Mr. Samuel Siltfence of Acme Excavating Co., Inc. The purpose of the inspection was to verify compliance with the *State Pollutant Discharge Elimination System (SPDES) General Permit for Storm Water Discharges from Construction Activity* ("the general permit").

The overall rating for the project at the time of the inspection was *unsatisfactory*. A copy of my inspection report is attached for your information. In addition to the report, I would like to elaborate on the following:

SPDES Authority

- In accordance with subdivision 750-2.1 (a) of Title 6 of the Official Compilation of Codes, Rules, and Regulations of the State of New York (6 NYCRR), a copy of your permit must be retained at the construction site. You did not have a copy of the general permit at the site. **Your failure to retain a copy of the general permit at the construction site is a violation of 6 NYCRR Part 750-2.1 (a).** Please retain a copy of the general permit at the site from this point forward.

SWPPP Content

- In accordance with Part III.E.2. of the general permit, contractors and subcontractors must certify that they understand the terms and conditions of the general permit and the SWPPP before undertaking any construction activity at the site. Your SWPPP does not include a certification statement from Acme Excavating Co., Inc. **The failure of your contractor to sign this certification before undertaking construction activity at the site is a violation of Part III.E.2. of the general permit.** Please obtain copies of all necessary certifications and provide copies of them to each party who holds a copy of your SWPPP.
- In accordance with Part V.H.2. of the general permit, SWPPP's must be certified by the permittee. Your SWPPP was not certified by you. **Your failure to certify your SWPPP is a**

Mr. John Smith
Re: SPDES Inspection
Blowing Leaves Subdivision
Gasper (T), Eaton (Co.)

<< Date >>

violation of Part V.H.2. of the general permit. Please certify your SWPPP.

Recordkeeping

- In accordance with Parts III.D.3.a. and III.D.3.b. of the general permit, permittees must have a qualified professional conduct site inspections within 24 hours of the end of 0.5" or greater rain events and at least once per week. A review of your records revealed that your "self-inspections" are only being conducted about two or three times per month. **Your failure to have a qualified professional conduct inspections at the required frequency is a violation of Part III.D.3.b. of the general permit.** Please immediately direct your qualified professional to conduct your site inspections at the required frequency.
- Although the frequency of self-inspections does not meet requirements, the quality of them is very good. Your qualified professional has accurately noted the same SWPPP deficiencies and necessary maintenance activities that I also observed, and prepared thorough sketches on the self-inspection site maps.
- In accordance with Part V.H.2. of the general permit, the permittee must certify all reports required by the permit. A review of your records showed that your self-inspection reports were not certified. **Your failure to certify your self-inspection reports is a violation of Part V.H.2. of the general permit.** Please sign and certify any and all existing and future self-inspection reports.

Visual Observations

- In accordance with Parts III.A.2. and III.A.3. of the general permit, all erosion and sediment controls (E&SC) measures must be installed (as detailed in the SWPPP) prior to the initiation of construction. During the inspection, I noted all of your E&SC measures have been correctly installed at the right times and locations.
- In accordance with Part V.L. of the general permit, all of the E&SC measures at your site must be maintained properly. While on site I observed that, among other things, the section of silt fence in place parallel to County Route 1 is in various stages of disrepair. **The failure of your contractor to adequately maintain the E&SC measures currently in place at your site is a violation of Part V.L. of the general permit.** Please direct your contractor to repair this silt fence immediately and to diligently maintain all of the other required E&SC measures as they are brought to his attention by your qualified professional.
- This inspection was conducted during a rain event which resulted in a stormwater discharge to the municipal separate storm sewer system (MS4) being operated by the Eaton County Department of Public Works. Your discharge was visibly turbid whereas upstream water MS4 was clear. As a result, the discharge from the MS4 outfall into Karimipour Creek was causing

Mr. John Smith
Re: SPDES Inspection
Blowing Leaves Subdivision
Gasper (T), Eaton (Co.)

<< Date >>

slight turbidity. Please be advised that the narrative water quality standard for turbidity in Karimipour Creek is “no increase that will cause a substantial visible contrast to natural conditions.” I attribute the lack of maintenance of your E&SC measures to be the primary cause of the turbid discharge. Please be reminded that the general permit does not authorize you cause or contribute to a condition in contravention of any water quality standards.

If you have any questions or comments, please feel free to contact me at (999) 456-5432.

Sincerely,

Hector D. Inspector, CPESC
Environmental Program Specialist 2

HDI:ms
Attachment

cc w/att.: Chester Checkdam, (T) Gasper Code Enforcement Officer
Samuel Siltfence, Acme Excavating Co., Inc.

Appendix 11 | Contractor Certification Form

CONTRACTOR'S CERTIFICATION
Pursuant to
NYS DEC GENERAL PERMIT GP-0-20-001

Pursuant to the SPDES General Permit for Stormwater Discharges from Construction Activity (Permit GP-0-20-001) Part III.a.6, all contractors and subcontractors implementing all, or a portion of the Stormwater Pollution Prevention Plan (SWPPP) shall sign a copy of the following certification statement before undertaking any construction activity at the site identification in the SWPPP:

"I hereby certify under penalty of law that I understand and agree to comply with the terms and conditions of the SWPPP and agree to implement any corrective actions identified by the qualified inspector during a site inspection. I also understand that the owner or operator must comply with the terms and conditions of the most current version of the New York State Pollutant Discharge Elimination System ("SPDES") general permit for stormwater discharges from construction activities and that it is unlawful for any person to cause or contribute to a violation of water quality standards. Furthermore, I am aware that there are significant penalties for submitting false information, that I do not believe to be true, including the possibility of fine and imprisonment for knowing violations"

Signature

Print Name

Date

Contracting Firm Information:

Contracting Firm Name:

Address:

Telephone Number:

Address of Site:

Name of trained individual responsible for SWPPP implementation, and who shall be on site on a daily basis when soil disturbance activities are being performed:

Name: _____

Title: _____

Appendix 12 | NYSDEC Deep-Ripping & Decompaction Manual



New York State
DEPARTMENT OF ENVIRONMENTAL CONSERVATION

Division of Water

Deep-Ripping and Decompaction

April 2008

New York State
Department of Environmental Conservation

Document Prepared by:

John E. Lacey,
Land Resource Consultant and Environmental Compliance Monitor
(Formerly with the Division of Agricultural Protection and Development Services,
NYS Dept. of Agriculture & Markets)

Alternative Stormwater Management Deep-Ripping and Decompaction

Description

The two-phase practice of 1) “Deep Ripping;” and 2) “Decompaction” (deep subsoiling), of the soil material as a step in the cleanup and restoration/landscaping of a construction site, helps mitigate the physically induced impacts of soil compression; i.e.: soil compaction or the substantial increase in the bulk density of the soil material.

Deep Ripping and Decompaction are key factors which help in restoring soil pore space and permeability for water infiltration. Conversely, the physical actions of cut-and-fill work, land grading, the ongoing movement of construction equipment and the transport of building materials throughout a site alter the architecture and structure of the soil, resulting in: the mixing of layers (horizons) of soil materials, compression of those materials and diminished soil porosity which, if left unchecked, severely impairs the soil’s water holding capacity and vertical drainage (rainfall infiltration), from the surface downward.

In a humid climate region, compaction damage on a site is virtually guaranteed over the duration of a project. Soil in very moist to wet condition when compacted, will have severely reduced permeability. Figure 1 displays the early stage of the deep-ripping phase (Note that all topsoil was stripped prior to construction access, and it remains stockpiled until the next phase – decompaction – is complete). A heavy-duty tractor is pulling a three-shank ripper on the first of several series of incrementally deepening passes through the construction access corridor’s densely compressed subsoil material. Figure 2 illustrates the approximate volumetric composition of a loam surface soil when conditions are good for plant growth, with adequate natural pore space for fluctuating moisture conditions.



Fig. 1. A typical deep ripping phase of this practice, during the first in a series of progressively deeper “rips” through severely compressed subsoil.

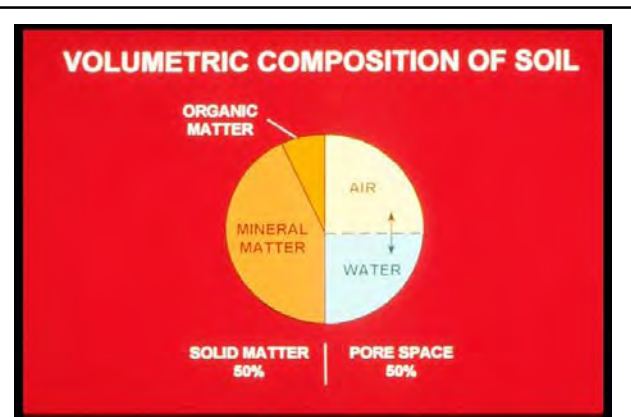

Fig. 2. About 50% of the volume of undisturbed loam surface soil is pore space, when soil is in good condition for plant growth. Brady, 2002.

Recommended Application of Practice

The objective of Deep Ripping and Decompaction is to effectively fracture (vertically and laterally) through the thickness of the physically compressed subsoil material (see Figure 3), restoring soil porosity and permeability and aiding infiltration to help reduce runoff. Together with topsoil stripping, the “two-phase” practice of Deep Ripping and Decompaction first became established as a “best management practice” through ongoing success on commercial farmlands affected by heavy utility construction right-of-way projects (transmission pipelines and large power lines).



Fig. 3. Construction site with significant compaction of the deep basal till subsoil extends 24 inches below this exposed cut-and-fill work surface.

Soil permeability, soil drainage and cropland productivity were restored. For broader construction application, the two-phase practice of Deep Ripping and Decompaction is best adapted to areas impacted with significant soil compaction, on contiguous open portions of large construction sites and inside long, open construction corridors used as temporary access over the duration of construction. Each mitigation area should have minimal above-and-below-ground obstructions for the easy avoidance and maneuvering of a large tractor and ripping/decompacting implements. Conversely, the complete two-phase practice is not recommended in congested or obstructed areas due to the limitations on tractor and implement movement.

Benefits

Aggressive “deep ripping” through the compressed thickness of exposed subsoil before the replacement/respreading of the topsoil layer, followed by “decompaction,” i.e.: “sub-soiling,” through the restored topsoil layer down into the subsoil, offers the following benefits:

- Increases the project (larger size) area’s direct surface infiltration of rainfall by providing the open site’s mitigated soil condition and lowers the demand on concentrated runoff control structures
- Enhances direct groundwater recharge through greater dispersion across and through a broader surface than afforded by some runoff-control structural measures
- Decreases runoff volume generated and provides hydrologic source control
- May be planned for application in feasible open locations either alone or in

conjunction with plans for structural practices (e.g., subsurface drain line or infiltration basin) serving the same or contiguous areas

- Promotes successful long-term revegetation by restoring soil permeability, drainage and water holding capacity for healthy (rather than restricted) root-system development of trees, shrubs and deep rooted ground cover, minimizing plant drowning during wet periods and burnout during dry periods.

Feasibility/Limitations

The effectiveness of Deep Ripping and Decompaction is governed mostly by site factors such as: the original (undisturbed) soil's hydrologic characteristics; the general slope; local weather/timing (soil moisture) for implementation; the space-related freedom of equipment/implement maneuverability (noted above in **Recommended Application of Practice**), and by the proper selection and operation of tractor and implements (explained below in **Design Guidance**). The more notable site-related factors include:

Soil

In the undisturbed condition, each identified soil type comprising a site is grouped into one of four categories of soil hydrology, Hydrologic Soil Group A, B, C or D, determined primarily by a range of characteristics including soil texture, drainage capability when thoroughly wet, and depth to water table. The natural rates of infiltration and transmission of soil-water through the undisturbed soil layers for Group A is "high" with a low runoff potential while soils in Group B are moderate in infiltration and the transmission of soil-water with a moderate runoff potential, depending somewhat on slope. Soils in Group C have slow rates of infiltration and transmission of soil-water and a moderately high runoff potential influenced by soil texture and slope; while soils in Group D have exceptionally slow rates of infiltration and transmission of soil-water, and high runoff potential.

In Figure 4, the profile displays the undisturbed horizons of a soil in Hydrologic Soil Group C and the naturally slow rate of infiltration through the subsoil. The slow rate of infiltration begins immediately below the topsoil horizon (30 cm), due to the limited amount of macro pores, e.g.: natural subsoil fractures, worm holes and root channels. Infiltration after the construction-induced mixing and compression of such subsoil material is virtually absent; but can be restored back to this natural level with the two-phase practice of deep ripping and decompaction, followed by the permanent establishment of an appropriate, deep taproot

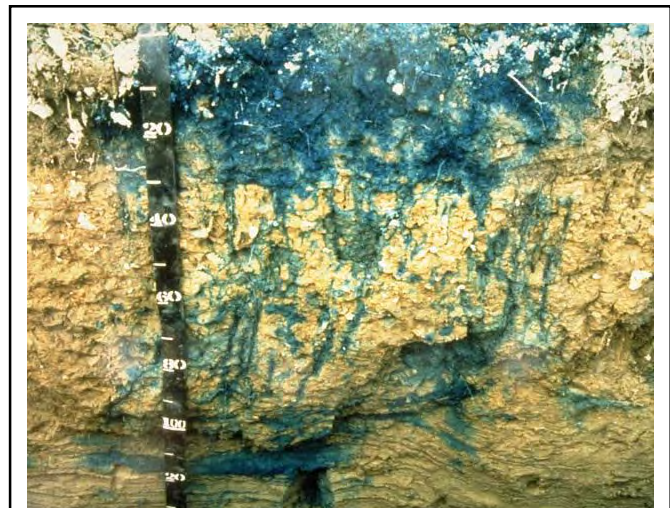

Fig. 4. Profile (in centimeters) displaying the infiltration test result of the natural undisturbed horizons of a soil in Hydrologic Soil Group C.

lawn/ground cover to help maintain the restored subsoil structure. Infiltration after construction-induced mixing and compression of such subsoil material can be notably rehabilitated with the Deep Ripping and Decompaction practice, which prepares the site for the appropriate long-term lawn/ground cover mix including deep taproot plants such as clover, fescue or trefoil, etc. needed for all rehabilitated soils.

Generally, soils in Hydrologic Soil Groups A and B, which respectively may include deep, well-drained, sandy-gravelly materials or deep, moderately well-drained basal till materials, are among the easier ones to restore permeability and infiltration, by deep ripping and decompaction. Among the many different soils in Hydrologic Soil Group C are those unique glacial tills having a natural fragipan zone, beginning about 12 to 18 inches (30 – 45cm), below surface. Although soils in Hydrologic Soil Group C do require a somewhat more carefully applied level of the Deep Ripping and Decompaction practice, it can greatly benefit such affected areas by reducing the runoff and fostering infiltration to a level equal to that of pre-disturbance.

Soils in Hydrologic Soil Group D typically have a permanent high water table close to the surface, influenced by a clay or other highly impervious layer of material. In many locations with clay subsoil material, the bulk density is so naturally high that heavy trafficking has little or no added impact on infiltration; and structural runoff control practices rather than Deep Ripping and Decompaction should be considered.

The information about Hydrologic Soil Groups is merely a general guideline. Site-specific data such as limited depths of cut-and-fill grading with minimal removal or translocation of the inherent subsoil materials (as analyzed in the county soil survey) or, conversely, the excavation and translocation of deeper, unconsolidated substratum or consolidated bedrock materials (unlike the analyzed subsoil horizons' materials referred to in the county soil survey) should always be taken into account.

Sites made up with significant quantities of large rocks, or having a very shallow depth to bedrock, are not conducive to deep ripping and decompaction (subsoiling); and other measures may be more practical.

Slope

The two-phase application of 1) deep ripping and 2) decompaction (deep subsoiling), is most practical on flat, gentle and moderate slopes. In some situations, such as but not limited to temporary construction access corridors, inclusion areas that are moderately steep along a project's otherwise gentle or moderate slope may also be deep ripped and decompacted. For limited instances of moderate steepness on other projects, however, the post-construction land use and the relative alignment of the potential ripping and decompaction work in relation to the lay of the slope should be reviewed for safety and practicality. In broad construction areas predominated by moderately steep or steep slopes, the practice is generally not used.

Local Weather/Timing/Soil Moisture

Effective fracturing of compressed subsoil material from the exposed work surface, laterally and vertically down through the affected zone is achieved only when the soil material is moderately dry to moderately moist. Neither one of the two-phases, deep ripping nor decompaction (deep

subsoiling), can be effectively conducted when the soil material (subsoil or replaced topsoil) is in either a “plastic” or “liquid” state of soil consistency. Pulling the respective implements legs through the soil when it is overly moist only results in the “slicing and smearing” of the material or added “squeezing and compression” instead of the necessary fracturing. Ample drying time is needed for a “rippable” soil condition not merely in the material close to the surface, but throughout the material located down to the bottom of the physically compressed zone of the subsoil.

The “poor man’s Atterberg field test” for soil plasticity is a simple “hand-roll” method used for quick, on-site determination of whether or not the moisture level of the affected soil material is low enough for: effective deep ripping of subsoil; respreading of topsoil in a friable state; and final decompaction (deep subsoiling). Using a sample of soil material obtained from the planned bottom depth of ripping, e.g.: 20 - 24 inches below exposed subsoil surface, the sample is hand rolled between the palms down to a 1/8-inch diameter thread. (Use the same test for stored topsoil material before respreading on the site.) If the respective soil sample crumbles apart in segments no greater than 3/8 of an inch long, by the time it is rolled down to 1/8 inch diameter, it is low enough in moisture for deep ripping (or topsoil replacement), and decompaction. Conversely, as shown in Figure 5, if the rolled sample stretches out in increments greater than 3/8 of an inch long before crumbling, it is in a “plastic” state of soil consistency and is too wet for subsoil ripping (as well as topsoil replacement) and final decompaction.



Fig. 5. Augered from a depth of 19 inches below the surface of the replaced topsoil, this subsoil sample was hand rolled to a 1/8-inch diameter. The test shows the soil at this site stretches out too far without crumbling; it indicates the material is in a plastic state of consistence, too wet for final decompaction (deep subsoiling) at this time.

Design Guidance

Beyond the above-noted site factors, a vital requirement for the effective Deep Ripping and Decompaction (deep subsoiling), is implementing the practice in its distinct, two-phase process:

- 1) Deep rip the affected thickness of exposed subsoil material (see Figure 10 and 11), aggressively fracturing it before the protected topsoil is reapplied on the site (see Figure 12); and
- 2) Decompact (deep subsoil), simultaneously through the restored topsoil layer and the upper half of the affected subsoil (Figure 13). The second phase, “decompaction,” mitigates the partial recompaction which occurs during the heavy process of topsoil spreading/grading. Prior to deep ripping and decompacting the site, all construction activity, including construction equipment and material storage, site cleanup and trafficking (Figure 14), should be finished; and the site closed off to further disturbance. Likewise, once the practice is underway and the area’s soil permeability and

rainfall infiltration are being restored, a policy limiting all further traffic to permanent travel lanes is maintained.

The other critical elements, outlined below, are: using the proper implements (deep, heavy-duty rippers and subsoilers), and ample pulling-power equipment (tractors); and conducting the practice at the appropriate speed, depth and pattern(s) of movement.

Note that an appropriate plan for the separate practice of establishing a healthy perennial ground cover, with deep rooting to help maintain the restored soil structure, should be developed in advance. This may require the assistance of an agronomist or landscape horticulturist.

Implements

Avoid the use of all undersize implements. The small-to-medium, light-duty tool will, at best, only “scarify” the uppermost surface portion of the mass of compacted subsoil material. The term “chisel plow” is commonly but incorrectly applied to a broad range of implements. While a few may be adapted for the moderate subsoiling of non-impacted soils, the majority are less durable and used for only lighter land-fitting (see Figure 6).



Fig. 6. A light duty chisel implement, not adequate for either the deep ripping or decompaction (deep subsoiling) phase.



Fig. 7. One of several variations of an agricultural ripper. This unit has long, rugged shanks mounted on a steel V-frame for deep, aggressive fracturing through Phase 1.

Use a “heavy duty” agricultural-grade, deep ripper (see Figures 7,9,10 and 11) for the first phase: the lateral and vertical fracturing of the mass of exposed and compressed subsoil, down and through, to the bottom of impact, prior to the replacement of the topsoil layer. (Any oversize rocks which are uplifted to the subsoil surface during the deep ripping phase are picked and removed.) Like the heavy-duty class of implement for the first phase, the decompaction (deep subsoiling) of Phase 2 is conducted with the heavy-duty version of the deep subsoiler. More preferable is the angled-leg variety of deep subsoiler (shown in Figures 8 and 13). It minimizes the inversion of the subsoil and topsoil layers while laterally and vertically fracturing the upper half of the previously ripped subsoil layer and all of the topsoil layer by delivering a momentary, wave-like “lifting and shattering” action up through the soil layers as it is pulled.

Pulling-Power of Equipment

Use the following rule of thumb for tractor horsepower (hp) whenever deep ripping and decompacting a significantly impacted site: For both types of implement, have at least 40 hp of tractor pull available for each mounted shank/ leg.

Using the examples of a 3-shank and a 5-shank implement, the respective tractors should have 120 and 200 hp available for fracturing down to the final depth of 20-to-24 inches per phase. Final depth for the deep ripping in Phase 1 is achieved incrementally by a progressive series of passes (see Depth and Patterns of Movement, below); while for Phase 2, the full operating depth of the deep subsoiler is applied from the beginning.

The operating speed for pulling both types of implement should not exceed 2 to 3 mph. At this slow and managed rate of operating speed, maximum functional performance is sustained by the tractor and the implement performing the soil fracturing. Referring to Figure 8, the implement is the 6-leg version of the deep angled-leg subsoiler. Its two outside legs are “chained up” so that only four legs will be engaged (at the maximum depth), requiring no less than 160 hp, (rather than 240 hp) of pull. The 4-wheel drive, articulated-frame tractor in Figure 8 is 174 hp. It will be decompacting this unobstructed, former construction access area simultaneously through 11 inches of replaced topsoil and the upper 12 inches of the previously deep-ripped subsoil. In constricted areas of Phase 1) Deep Ripping, a medium-size tractor with adequate hp, such as the one in Figure 9 pulling a 3-shank deep ripper, may be more maneuverable.

Some industrial-grade variations of ripping implements are attached to power graders and bulldozers. Although highly durable, they are generally not recommended. Typically, the shanks or “teeth” of these rippers are too short and stout; and they are mounted too far apart to achieve the well-distributed type of lateral and vertical fracturing of the soil materials necessary to restore soil permeability and infiltration. In addition, the power graders and bulldozers, as pullers, are far less maneuverable for turns and patterns than the tractor.



Fig. 8. A deep, angled-leg subsoiler, ideal for Phase 2 decompaction of after the topsoil layer is graded on top of the ripped subsoil.



Fig. 9. This medium tractor is pulling a 3-shank deep ripper. The severely compacted construction access corridor is narrow, and the 120 hp tractor is more maneuverable for Phase 1 deep ripping (subsoil fracturing), here.

Depth and Patterns of Movement

As previously noted both Phase 1 Deep Ripping through significantly compressed, exposed subsoil and Phase 2 Decompaction (deep subsoiling) through the replaced topsoil and upper subsoil need to be performed at maximum capable depth of each implement. With an implement's guide wheels attached, some have a "normal" maximum operating depth of 18 inches, while others may go deeper. In many situations, however, the tractor/implement operator must first remove the guide wheels and other non essential elements from the implement. This adapts the ripper or the deep subsoiler for skillful pulling with its frame only a few inches above surface, while the shanks or legs, fracture the soil material 20-to-24 inches deep.

There may be construction sites where the depth of the exposed subsoil's compression is moderate, e.g.: 12 inches, rather than deep. This can be verified by using a $\frac{3}{4}$ inch cone penetrometer and a shovel to test the subsoil for its level of compaction, incrementally, every three inches of increasing depth. Once the full thickness of the subsoil's compacted zone is finally "pieced" and there is a significant drop in the psi measurements of the soil penetrometer, the depth/thickness of compaction is determined. This is repeated at several representative locations of the construction site. If the thickness of the site's subsoil compaction is verified as, for example, ten inches, then the Phase 1 Deep Ripping can be correspondingly reduced to the implement's minimum operable depth of 12 inches. However, the Phase 2 simultaneous Decompaction (subsoiling) of an 11 inch thick layer of replaced topsoil and the upper subsoil should run at the subsoiling implements full operating depth.



Fig. 10. An early pass with a 3-shank deep ripper penetrating only 8 inches into this worksite's severely compressed subsoil.



Fig. 11. A repeat run of the 3-shank ripper along the same patterned pass area as Fig. 9; here, incrementally reaching 18 of the needed 22 inches of subsoil fracture.

Typically, three separate series (patterns) are used for both the Phase 1 Deep Ripping and the Phase 2 Decompaction on significantly compacted sites. For Phase 1, each series begins with a moderate depth of rip and, by repeat-pass, continues until full depth is reached. Phase 2 applies the full depth of Decompaction (subsoiling), from the beginning.

Every separate series (pattern) consists of parallel, forward-and-return runs, with each progressive

pass of the implement's legs or shanks evenly staggered between those from the previous pass. This compensates for the shank or leg-spacing on the implement, e.g., with 24-to-30 inches between each shank or leg. The staggered return pass ensures lateral and vertical fracturing actuated every 12 to 15 inches across the densely compressed soil mass.

Large, Unobstructed Areas

For larger easy areas, use the standard patterns of movement:

- The first series (pattern) of passes is applied lengthwise, parallel with the longest spread of the site; gradually progressing across the site's width, with each successive pass.
- The second series runs obliquely, crossing the first series at an angle of about 45 degrees.
- The third series runs at right angle (or 90 degrees), to the first series to complete the fracturing and shattering on severely compacted sites, and avoid leaving large unbroken blocks of compressed soil material. (In certain instances, the third series may be optional, depending on how thoroughly the first two series loosen the material and eliminate large chunks/blocks of material as verified by tests with a 3/4-inch cone penetrometer.)



Fig. 12. Moderately dry topsoil is being replaced on the affected site now that Phase 1 deep ripping of the compressed subsoil is complete.



Fig. 13. The same deep, angled-leg subsoiler shown in Fig. 7 is engaged at maximum depth for Phase 2, decompaction (deep soiling), of the replaced topsoil and the upper subsoil materials.

Corridors

In long corridors of limited width and less maneuverability than larger sites, e.g.: along compacted areas used as temporary construction access, a modified series of pattern passes are used.

- First, apply the same initial lengthwise, parallel series of passes described above.

- A second series of passes makes a broad “S” shaped pattern of rips, continually and gradually alternating the “S” curves between opposite edges inside the compacted corridor.
- The third and final series again uses the broad, alternating S pattern, but it is “flip-flopped” to continually cross the previous S pattern along the corridor’s centerline. This final series of the S pattern curves back along the edge areas skipped by the second series.

Maintenance and Cost

Once the two-phase practice of Deep Ripping and Decompan is completed, two items are essential for maintaining a site’s soil porosity and permeability for infiltration. They are: planting and maintaining the appropriate ground cover with deep roots to maintain the soil structure (see Figure 15); and keeping the site free of traffic or other weight loads.

Note that site-specific choice of an appropriate vegetative ground-cover seed mix, including the proper seeding ratio of one or more perennial species with a deep taproot system and the proper amount of lime and soil nutrients (fertilizer mix) adapted to the soil-needs, are basic to the final practice of landscaping, i.e: surface tillage, seeding/planting/fertilizing and culti-packing or mulching is applied. The "maintenance" of an effectively deep-ripped and decompacted area is generally limited to the successful perennial (long-term) landscape ground cover; as long as no weight-bearing force of soil compaction is applied.



Fig. 14. The severely compacted soil of a temporary construction yard used daily by heavy equipment for four months; shown before deep ripping, topsoil replacement, and decompaction.



Fig. 15. The same site as Fig. 14 after deep ripping of the exposed subsoil, topsoil replacement, decompaction through the topsoil and upper subsoil and final surface tillage and revegetation to maintain soil permeability and infiltration.

The Deep Ripping and Decompaction practice is, by necessity, more extensive than periodic subsoiling of farmland. The cost of deep ripping and decompacting (deep subsoiling), will vary according to the depth and severity of soil-material compression and the relative amount of tractor and implement time that is required. In some instances, depending on open maneuverability, two-to-three acres of compacted project area may be deep-ripped in one day. In other situations of more severe compaction and - or less maneuverability, as little as one acre may be fully ripped in a day. Generally, if the Phase 1) Deep Ripping is fully effective, the Phase 2) Decompaction should be completed in $2/3$ to $3/4$ of the time required for Phase 1.

Using the example of two acres of Phase 1) Deep Ripping in one day, at \$1800 per day, the net cost is \$900 per acre. If the Phase 2) Decompacting or deep subsoiling takes $3/4$ the time as Phase 1, it costs \$675 per acre for a combined total of \$1575 per acre to complete the practice (these figures do not include the cost of the separate practice of topsoil stripping and replacement). Due to the many variables, it must be recognized that cost will be determined by the specific conditions or constraints of the site and the availability of proper equipment.

Resources

Publications:

- American Society of Agricultural Engineers. 1971. *Compaction of Agricultural Soils*. ASAE.
- Brady, N.C., and R.R. Weil. 2002. *The Nature and Properties of Soils*. 13th ed. Pearson Education, Inc.
- Baver, L.D. 1948. *Soil Physics*. John Wiley & Sons.
- Carpachi, N. 1987 (1995 fifth printing). *Excavation and Grading Handbook, Revised*. 2nd ed. Craftsman Book Company
- Ellis, B. (Editor). 1997. *Safe & Easy Lawn Care: The Complete Guide to Organic Low Maintenance Lawn*. Houghton Mifflin.
- Harpstead, M.I., T.J. Sauer, and W.F. Bennett. 2001. *Soil Science Simplified*. 4th ed. Iowa State University Press.
- Magdoff, F., and H. van Es. 2000. *Building Soils for Better Crops*. 2nd ed. Sustainable Agricultural Networks
- McCarthy, D.F. 1993. *Essentials of Soil Mechanics and Foundations, Basic Geotechnics* 4th ed. Regents/Prentice Hall.
- Plaster, E.J. 1992. *Soil Science & Management*. 3rd ed. Delmar Publishers.
- Union Gas Limited, Ontario, Canada. 1984. *Rehabilitation of Agricultural Lands, Dawn-Kerwood Loop Pipeline; Technical Report*. Ecological Services for Planning, Ltd.; Robinson, Merritt & Devries, Ltd. and Smith, Hoffman Associates, Ltd.
- US Department of Agriculture in cooperation with Cornell University Agricultural Experiment Station. Various years. *Soil Survey of (various names) County, New York*. USDA.

Internet Access:

- Examples of implements:
V-Rippers. Access by internet search of *John Deere Ag -New Equipment for 915* (larger-frame model) *V-Rippe*; and, *for 913* (smaller-frame model) *V-Ripper*. Deep, angled-leg subsoiler. Access by internet search of: *Bigham Brothers Shear Bolt Paratill-Subsoiler*.
http://salesmanual.deere.com/sales/salesmanual/en_NA/primary_tillage/2008/feature/rippers/915v_pattern_frame.html?sbu=ag&link=prodcats Last visited March 08.
- Soils data of USDA Natural Resources Conservation Service. *NRCS Web Soil Survey*. <http://websoilsurvey.nrcs.usda.gov/app/> and *USDA-NRCS Official Soil Series Descriptions; View by Name*. <http://ortho.ftw.nrcs.usda.gov/cgi-bin/osd/osdname.cgi> . Last visited Jan. 08.
- Soil penetrometer information. Access by internet searches of: *Diagnosing Soil Compaction using a Penetrometer (soil compaction tester)*, *PSU Extension*; as well as *Dickey-john Soil Compaction Tester*.
<http://www.dickey-johnproducts.com/pdf/SoilCompactionTest.pdf> and <http://cropsoil.psu.edu/Extension/Facts/uc178pdf> Last visited Sept. 07

Appendix 13 | NRCC Precipitation Tables

Extreme Precipitation Tables

Northeast Regional Climate Center

Data represents point estimates calculated from partial duration series. All precipitation amounts are displayed in inches.

Smoothing	Yes
State	New York
Location	
Longitude	74.425 degrees West
Latitude	41.423 degrees North
Elevation	0 feet
Date/Time	Wed, 04 Aug 2021 09:08:26 -0400

Extreme Precipitation Estimates

	5min	10min	15min	30min	60min	120min		1hr	2hr	3hr	6hr	12hr	24hr	48hr		1day	2day	4day	7day	10day	
1yr	0.33	0.50	0.62	0.82	1.02	1.26	1yr	0.88	1.18	1.45	1.77	2.17	2.64	3.07	1yr	2.33	2.95	3.38	4.08	4.71	1yr
2yr	0.39	0.60	0.75	0.98	1.24	1.54	2yr	1.07	1.43	1.76	2.15	2.62	3.17	3.63	2yr	2.80	3.49	4.00	4.71	5.37	2yr
5yr	0.46	0.71	0.89	1.19	1.53	1.92	5yr	1.32	1.77	2.20	2.70	3.28	3.96	4.57	5yr	3.50	4.40	5.01	5.80	6.57	5yr
10yr	0.51	0.81	1.02	1.38	1.80	2.27	10yr	1.55	2.08	2.62	3.21	3.89	4.68	5.45	10yr	4.14	5.24	5.96	6.79	7.66	10yr
25yr	0.60	0.95	1.21	1.67	2.23	2.85	25yr	1.92	2.57	3.29	4.05	4.90	5.85	6.87	25yr	5.18	6.61	7.49	8.38	9.40	25yr
50yr	0.68	1.09	1.39	1.95	2.62	3.38	50yr	2.26	3.01	3.91	4.81	5.81	6.94	8.20	50yr	6.14	7.89	8.90	9.82	10.98	50yr
100yr	0.77	1.24	1.60	2.27	3.09	4.01	100yr	2.67	3.54	4.66	5.73	6.91	8.22	9.79	100yr	7.28	9.42	10.59	11.52	12.82	100yr
200yr	0.87	1.42	1.84	2.64	3.65	4.76	200yr	3.15	4.17	5.54	6.82	8.22	9.75	11.70	200yr	8.63	11.25	12.61	13.52	14.99	200yr
500yr	1.04	1.71	2.24	3.25	4.55	5.97	500yr	3.93	5.17	6.96	8.57	10.32	12.23	14.81	500yr	10.82	14.24	15.90	16.72	18.44	500yr

Lower Confidence Limits

	5min	10min	15min	30min	60min	120min		1hr	2hr	3hr	6hr	12hr	24hr	48hr		1day	2day	4day	7day	10day	
1yr	0.29	0.44	0.54	0.73	0.89	1.11	1yr	0.77	1.09	1.26	1.61	1.98	2.41	2.61	1yr	2.14	2.51	2.86	3.36	3.93	1yr
2yr	0.37	0.58	0.71	0.96	1.19	1.43	2yr	1.03	1.40	1.62	2.07	2.56	3.09	3.52	2yr	2.73	3.39	3.90	4.58	5.23	2yr
5yr	0.42	0.65	0.81	1.11	1.41	1.66	5yr	1.22	1.62	1.88	2.42	3.01	3.69	4.26	5yr	3.27	4.10	4.70	5.40	6.16	5yr
10yr	0.46	0.71	0.88	1.24	1.60	1.86	10yr	1.38	1.82	2.10	2.66	3.38	4.23	4.92	10yr	3.74	4.73	5.39	6.05	6.87	10yr
25yr	0.53	0.80	1.00	1.42	1.87	2.13	25yr	1.62	2.09	2.47	3.19	3.91	5.06	5.96	25yr	4.48	5.73	6.49	6.93	7.93	25yr
50yr	0.58	0.88	1.10	1.58	2.12	2.40	50yr	1.83	2.35	2.77	3.61	4.38	5.82	6.90	50yr	5.15	6.63	7.48	7.68	8.85	50yr
100yr	0.64	0.97	1.21	1.75	2.40	2.69	100yr	2.07	2.63	3.12	4.09	4.92	6.72	8.02	100yr	5.95	7.71	8.62	9.08	9.84	100yr
200yr	0.71	1.07	1.36	1.97	2.74	3.01	200yr	2.37	2.94	3.51	4.66	5.53	7.77	9.32	200yr	6.88	8.96	9.97	10.26	10.93	200yr
500yr	0.83	1.23	1.58	2.30	3.27	3.50	500yr	2.82	3.42	4.11	5.55	6.50	9.44	11.40	500yr	8.36	10.96	12.11	12.05	12.57	500yr

Upper Confidence Limits

	5min	10min	15min	30min	60min	120min		1hr	2hr	3hr	6hr	12hr	24hr	48hr		1day	2day	4day	7day	10day	
1yr	0.36	0.55	0.68	0.91	1.12	1.35	1yr	0.97	1.32	1.53	1.95	2.40	2.83	3.31	1yr	2.50	3.18	3.65	4.37	5.11	1yr
2yr	0.41	0.63	0.78	1.05	1.30	1.54	2yr	1.12	1.51	1.76	2.23	2.78	3.29	3.75	2yr	2.91	3.61	4.17	4.96	5.61	2yr
5yr	0.50	0.77	0.95	1.31	1.66	1.98	5yr	1.43	1.93	2.25	2.88	3.58	4.27	4.88	5yr	3.78	4.69	5.32	6.20	6.95	5yr
10yr	0.59	0.91	1.13	1.58	2.04	2.44	10yr	1.76	2.39	2.74	3.54	4.38	5.22	5.99	10yr	4.62	5.76	6.44	7.45	8.40	10yr
25yr	0.75	1.14	1.41	2.02	2.66	3.25	25yr	2.29	3.18	3.64	4.64	5.73	6.79	7.82	25yr	6.01	7.52	8.31	9.50	10.69	25yr
50yr	0.89	1.35	1.68	2.42	3.26	3.73	50yr	2.81	3.64	4.46	5.68	7.00	8.27	9.57	50yr	7.32	9.20	10.09	11.44	12.85	50yr
100yr	1.06	1.60	2.01	2.90	3.98	4.54	100yr	3.44	4.43	5.47	6.94	8.57	10.08	11.73	100yr	8.92	11.28	12.23	13.99	15.46	100yr
200yr	1.27	1.91	2.42	3.50	4.88	5.53	200yr	4.21	5.40	6.72	8.50	10.49	12.29	14.38	200yr	10.88	13.82	14.84	16.89	18.61	200yr
500yr	1.61	2.40	3.08	4.48	6.37	7.16	500yr	5.49	7.00	8.83	11.11	13.70	15.94	18.78	500yr	14.11	18.06	19.15	21.67	23.82	500yr

Appendix 14 | Operation and Maintenance Plan

Stormwater Operation & Maintenance Plan

Site Drainage

A State Pollutant Discharge Elimination System Permit (SPDES GP 0-20-001) is required from the New York State Department of Environmental Conservation (NYSDEC) and a Storm Water Pollution Prevention Plan (SWPPP) has been prepared for review/approval by the Town of New Paltz (an MS4 community). The site improvements made to the parcel are new construction and will increase the impervious area on the site. The study provides the proposed improvements and provides measures that will be used to control potential impacts due to stormwater runoff.

Constructed Stormwater Control Practices

Catch Basins:

Catch basins on-site are utilized to collect stormwater run-off and melting snow from the paved parking areas, driveway and sidewalks. These are located along the centerline of roadside swales.

Roof leaders:

Roof leaders are utilized to collect stormwater run-off from the roof and discharge it into the subsurface chamber system.

Swirl chamber units:

The swirl chamber unit a compact, below grade stormwater treatment system that provides water quality mitigation. These systems receive overland flow through grated inlets as well as piped inlets from the various catch basins and drain/yard inlets located throughout the site.

Bioretention Areas:

These are shallow stormwater depressions which capture run-off from a surrounding drainage area (six inch deep surface ponding area) and then utilize an engineered soil strata and vegetation for treatment.

See Design Plans and Details for these improvements.

Typical Maintenance for Stormwater Practices

As a consequence of its function, the stormwater conveyance system collects and transports runoff that may contain certain pollutants. Maintaining catch basins, stormwater inlets, and the basins on a regular basis will remove pollutants, prevent clogging of the downstream conveyance system, restore catch basins' sediment trapping capacity, and ensure the system functions properly to avoid flooding.

Catch Basins:

Catch basins should be inspected monthly and after heavy rain fall to ensure they are functioning properly. Typical maintenance of catch basins includes removal of debris from the grate and sump. This can be done manually or using a vehicle equipped with a vacuum pump. Catch basins should be cleaned out at least one (1) time per year. A good time to clean out catch basins is in the spring to

remove the build-up of leaves, sand used for traction, dirt, and other debris that accumulates during winter months.

Roof leaders:

Roof leaders, similar to the catch basins, require typical maintenance which includes removal of debris manually. Inspections of the leaders should occur monthly and after heavy rain fall to ensure they are still functioning properly. These should be cleaned out at least one (1) time per year.

Swirl Chamber Systems:

The swirl chamber systems should be inspected at regular intervals and maintained when necessary to ensure optimum performance. The rate at which the system collects pollutants will depend more heavily on site activities than the size of the unit, i.e., unstable soils or heavy winter sanding will cause the treatment chamber to fill more quickly, but regular street sweeping will slow accumulation of said sediment and pollutants.

At a minimum, inspections should be performed twice per year (i.e. spring and fall) however more frequent inspections may be necessary in equipment wash down areas and in climates where winter sanding operations may lead to rapid accumulations of a large volume of sediment. The swirl chamber systems should be cleaned when the level of sediment has reached 75% of the capacity in the isolated sump or when significant level of hydrocarbons or trash has accumulated.

Cleaning of the swirl chamber systems should be done during dry weather conditions when no flow is entering the system. Cleanout of the swirl chamber system with a vacuum truck is generally the most effective and convenient method of excavating pollutants from the system. Disposal of all material removed from the swirl chamber systems should be done in accordance with local regulations. In many locations, disposal of evacuated sediments may be handled in the same manner as disposal of sediments removed from catch basins or deep sump manholes.

The Manufacturer's Operation and Maintenance Manual can be found in the appendix of the SWPPP. The minimum requirements to maintain intended operation are set forth by the manufacturer and should be strictly adhered to.

Bioretention Areas:

These areas should be inspected monthly and after heavy rain fall to ensure they are functioning properly. Typical maintenance of the bio-retention areas include removal of debris, weeding (especially in the first couple of years while the plants are establishing their root systems) and mulching. Any areas devoid of mulch shall be re-mulched on an annual basis. Dead or diseased plant material shall be replaced immediately.

Silt/Sediment removal from the filter bed shall be conducted when the accumulation exceeds one inch or every five to six years. If the filter bed ponds water at the surface for more than 48 hours, the top 4-6 inches (below the mulch) of material shall be removed and replaced with fresh material. Any plant material removed during clean-out shall be replaced in-kind.

See Design Plans and Details for the components of the soil mixture for the filter bed.

Stormwater Basins:

These basins should be inspected monthly (this includes the inlets pipes, rip-rap, embankments, outlet control structure, emergency spillway and fencing) and after heavy rain fall to ensure proper functionality.

Long-term Stormwater Basin maintenance requires the following:

- Mowing grass, at least twice yearly. Grass clippings and other debris must be removed from the basin area after each cutting. Removal of woody brush and trees. Reestablish good grass cover in areas where woody material has been removed.
- Leaves shall be removed as needed from the basin and outlet control structure.
- Restore and reseed eroded any areas and gullies along embankment areas. Reoccurring erosion should be inspected by a licensed professional engineer to determine probable cause and remedial action that may be necessary.
- General maintenance and repairs of the stormwater outlet and inlet structures.
- Sediment removal from forebay and micropool every five to six years or when 50% full.
- The emergency spillway must remain free of debris and maintain the design elevation in order to convey stormwater during a catastrophic storm event.

In general, any deficiencies identified during the regular inspections or otherwise for all the stormwater management facilities should be corrected immediately. See appendices for forms to record inspection and maintenance work for the stormwater facilities.

r:\projects\2020\20006912d\reports\drainage\dewpoint north\may 2024 - r2\report\appendix\pieces - appendix 14 - o & m plan\stormwater operation & maintenance plan appendix.docx



Engineering & Design

Colliers Engineering & Design is a trusted provider of multi-discipline engineering, design and consulting services providing customized solutions for public and private clients through a network of offices nationwide.

For a full listing of our office locations, please visit colliersengineering.com

1 845 564 4495



*Civil/Site • Traffic/Transportation • Governmental • Survey/Geospatial
Infrastructure • Geotechnical/Environmental • Telecommunications • Utilities/Energy*

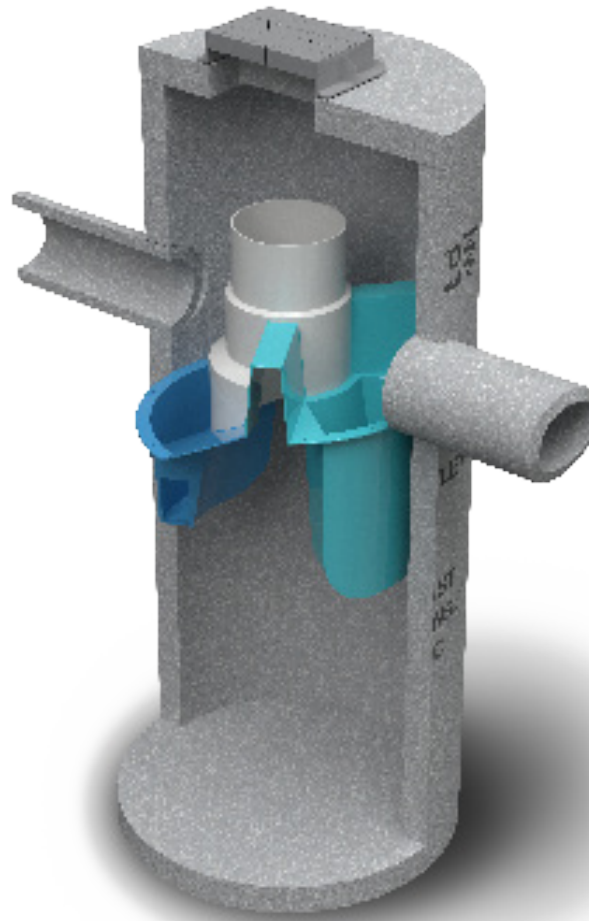

Operation and Maintenance Manual

First Defense[®] High Capacity and First Defense[®] Optimum

Vortex Separator for Stormwater Treatment

Table of Contents

3	FIRST DEFENSE® BY HYDRO INTERNATIONAL <ul style="list-style-type: none">- INTRODUCTION- OPERATION- POLLUTANT CAPTURE AND RETENTION
4	MODEL SIZES & CONFIGURATIONS <ul style="list-style-type: none">- FIRST DEFENSE® COMPONENTS
5	MAINTENANCE <ul style="list-style-type: none">- OVERVIEW- MAINTENANCE EQUIPMENT CONSIDERATIONS- DETERMINING YOUR MAINTENANCE SCHEDULE
6	MAINTENANCE PROCEDURES <ul style="list-style-type: none">- INSPECTION- FLOATABLES AND SEDIMENT CLEAN OUT
8	FIRST DEFENSE® INSTALLATION LOG
9	FIRST DEFENSE® INSPECTION AND MAINTENANCE LOG

COPYRIGHT STATEMENT: The contents of this manual, including the graphics contained herein, are intended for the use of the recipient to whom the document and all associated information are directed. Hydro International plc owns the copyright of this document, which is supplied in confidence. It must not be used for any purpose other than that for which it is supplied and must not be reproduced, in whole or in part stored in a retrieval system or transmitted in any form or by any means without prior permission in writing from Hydro International plc. First Defense® is a trademarked hydrodynamic vortex separation device of Hydro International plc. A patent covering the First Defense® has been granted.

DISCLAIMER: Information and data contained in this manual is exclusively for the purpose of assisting in the operation and maintenance of Hydro International plc's First Defense®. No warranty is given nor can liability be accepted for use of this information for any other purpose. Hydro International plc has a policy of continuous product development and reserves the right to amend specifications without notice.

I. First Defense® by Hydro International

Introduction

The First Defense® is an enhanced vortex separator that combines an effective and economical stormwater treatment chamber with an integral peak flow bypass. It efficiently removes total suspended solids (TSS), trash and hydrocarbons from stormwater runoff without washing out previously captured pollutants. The First Defense® is available in several model configurations to accommodate a wide range of pipe sizes, peak flows and depth constraints.

The two product models described in this guide are the First Defense® High Capacity and the First Defense® Optimum; they are inspected and maintained identically.

Operation

The First Defense® operates on simple fluid hydraulics. It is self-activating, has no moving parts, no external power requirement and is fabricated with durable non-corrosive components. No manual procedures are required to operate the unit and maintenance is limited to monitoring accumulations of stored pollutants and periodic clean-outs. The First Defense® has been designed to allow for easy and safe access for inspection, monitoring and clean-out procedures. Neither entry into the unit nor removal of the internal components is necessary for maintenance, thus safety concerns related to confined-space-entry are avoided.

Pollutant Capture and Retention

The internal components of the First Defense® have been designed to optimize pollutant capture. Sediment is captured and retained in the base of the unit, while oil and floatables are stored on the water surface in the inner volume (Fig.1).

The pollutant storage volumes are isolated from the built-in bypass chamber to prevent washout during high-flow storm events. The sump of the First Defense® retains a standing water level between storm events. This ensures a quiescent flow regime at the onset of a storm, preventing resuspension and washout of pollutants captured during previous events.

Accessories such as oil absorbent pads are available for enhanced oil removal and storage. Due to the separation of the oil and floatable storage volume from the outlet, the potential for washout of stored pollutants between clean-outs is minimized.

Applications

- Stormwater treatment at the point of entry into the drainage line
- Sites constrained by space, topography or drainage profiles with limited slope and depth of cover
- Retrofit installations where stormwater treatment is placed on or tied into an existing storm drain line
- Pretreatment for filters, infiltration and storage

Advantages

- Inlet options include surface grate or multiple inlet pipes
- Integral high capacity bypass conveys large peak flows without the need for “offline” arrangements using separate junction manholes
- Long flow path through the device ensures a long residence time within the treatment chamber, enhancing pollutant settling
- Delivered to site pre-assembled and ready for installation

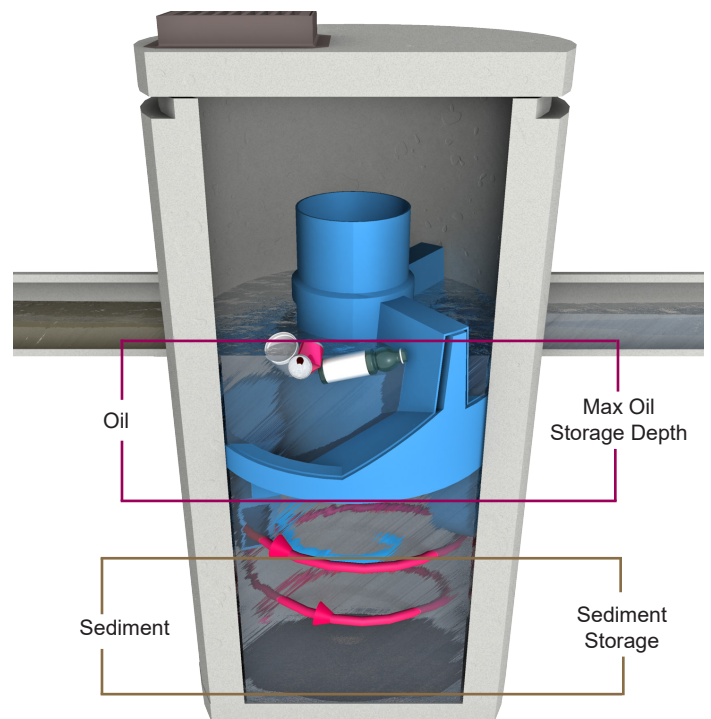

Fig.1 Pollutant storage volumes in the First Defense®.

II. Model Sizes & Configurations

The First Defense® inlet and internal bypass arrangements are available in several model sizes and configurations. The components have modified geometries allowing greater design flexibility to accommodate various site constraints.

All First Defense® models include the internal components that are designed to remove and retain total suspended solids (TSS), gross solids, floatable trash and hydrocarbons (Fig.2). First Defense® model sizes (diameter) are shown in Table 1.

III. Maintenance

First Defense® Components

- | | | |
|--------------------|-----------------------------|-------------------------|
| 1. Built-In Bypass | 4. Floatables Draw-off Port | 7. Sediment Storage |
| 2. Inlet Pipe | 5. Outlet Pipe | 8. Inlet Grate or Cover |
| 3. Inlet Chute | 6. Floatables Storage | |

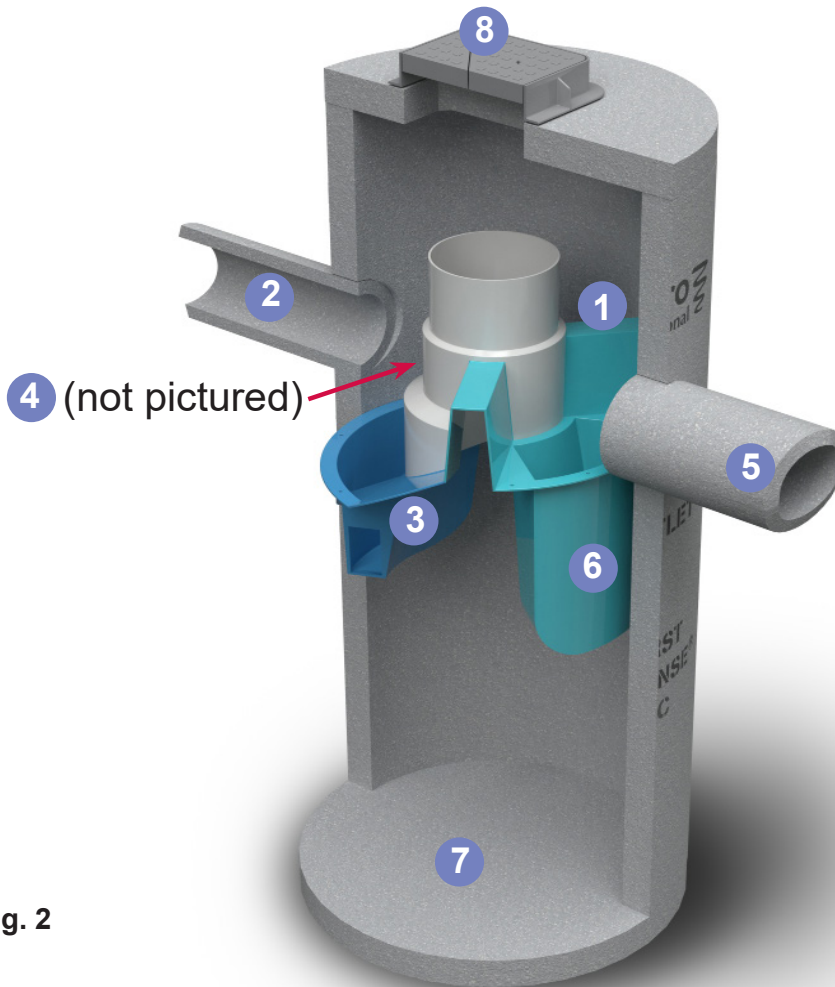

Fig. 2

Table 1

First Defense® Model Sizes
(ft / m) diameter
3 / 0.9
4 / 1.2
5 / 1.5
6 / 1.8
7 / 2.1
8 / 2.4
10 / 3.0

Overview

The First Defense® protects the environment by removing a wide range of pollutants from stormwater runoff. Periodic removal of these captured pollutants is essential to the continuous, long-term functioning of the First Defense®. The First Defense® will capture and retain sediment and oil until the sediment and oil storage volumes are full to capacity. When sediment and oil storage capacities are reached, the First Defense® will no longer be able to store removed sediment and oil.

The First Defense® allows for easy and safe inspection, monitoring and clean-out procedures. A commercially or municipally owned sump-vac is used to remove captured sediment and floatables. Access ports are located in the top of the manhole.

Maintenance events may include Inspection, Oil & Floatables Removal, and Sediment Removal. Maintenance events do not require entry into the First Defense®, nor do they require the internal components of the First Defense® to be removed. In the case of inspection and floatables removal, a vactor truck is not required. However, a vactor truck is required if the maintenance event is to include oil removal and/or sediment removal.

Maintenance Equipment Considerations

The internal components of the First Defense® have a centrally located circular shaft through which the sediment storage sump can be accessed with a sump vac hose. The open diameter of this access shaft is 15 inches in diameter (Fig.3). Therefore, the nozzle fitting of any vactor hose used for maintenance should be less than 15 inches in diameter.

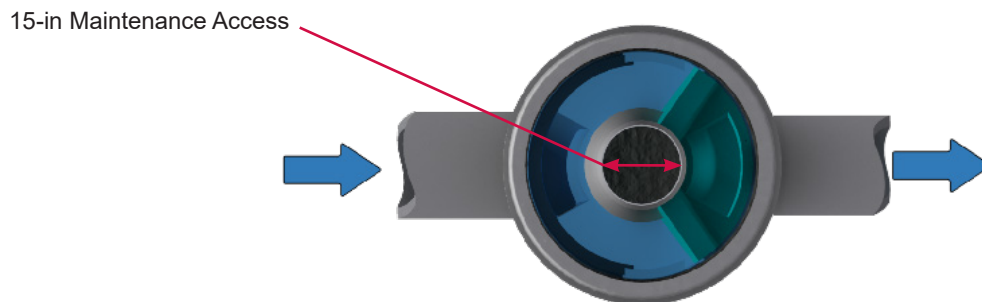

Fig.3 The central opening to the sump of the First Defense® is 15 inches in diameter.

Determining Your Maintenance Schedule

The frequency of clean out is determined in the field after installation. During the first year of operation, the unit should be inspected every six months to determine the rate of sediment and floatables accumulation. A simple probe such as a Sludge-Judge® can be used to determine the level of accumulated solids stored in the sump. This information can be recorded in the maintenance log (see page 9) to establish a routine maintenance schedule.

The vactor procedure, including both sediment and oil / floatables removal, for First Defense® typically takes less than 30 minutes and removes a combined water/oil volume of about 765 gallons.

Inspection Procedures

1. Set up any necessary safety equipment around the access port or grate of the First Defense® as stipulated by local ordinances. Safety equipment should notify passing pedestrian and road traffic that work is being done.
2. Remove the grate or lid to the manhole.
3. Without entering the vessel, look down into the chamber to inspect the inside. Make note of any irregularities. Fig.4 shows the standing water level that should be observed.
4. Without entering the vessel, use the pole with the skimmer net to remove floatables and loose debris from the components and water surface.
5. Using a sediment probe such as a Sludge Judge®, measure the depth of sediment that has collected in the sump of the vessel.
6. On the Maintenance Log (see page 9), record the date, unit location, estimated volume of floatables and gross debris removed, and the depth of sediment measured. Also note any apparent irregularities such as damaged components or blockages.
7. Securely replace the grate or lid.
8. Take down safety equipment.
9. Notify Hydro International of any irregularities noted during inspection.

Floatables and Sediment Clean Out

Floatables clean out is typically done in conjunction with sediment removal. A commercially or municipally owned sump-vac is used to remove captured sediment and floatables (Fig.4).

Floatables and loose debris can also be netted with a skimmer and pole. The access port located at the top of the manhole provides unobstructed access for a vactor hose to be lowered to the base of the sump.

Scheduling

- Floatables and sump clean out are typically conducted once a year during any season.
- Floatables and sump clean out should occur as soon as possible following a spill in the contributing drainage area.



Fig.4 Floatables are removed with a vactor hose

Recommended Equipment

- Safety Equipment (traffic cones, etc)
- Crow bar or other tool to remove grate or lid
- Pole with skimmer or net (if only floatables are being removed)
- Sediment probe (such as a Sludge Judge®)
- Vactor truck (flexible hose recommended)
- First Defense® Maintenance Log

Floatables and Sediment Clean Out Procedures

1. Set up any necessary safety equipment around the access port or grate of the First Defense® as stipulated by local ordinances. Safety equipment should notify passing pedestrian and road traffic that work is being done.
2. Remove the grate or lid to the manhole.
3. Without entering the vessel, look down into the chamber to inspect the inside. Make note of any irregularities.
4. Remove oil and floatables stored on the surface of the water with the vacator hose or with the skimmer or net
5. Using a sediment probe such as a Sludge Judge®, measure the depth of sediment that has collected in the sump of the vessel and record it in the Maintenance Log (page 9).
6. Once all floatables have been removed, drop the vacator hose to the base of the sump. Vacator out the sediment and gross debris off the sump floor
7. Retract the vacator hose from the vessel.
8. On the Maintenance Log provided by Hydro International, record the date, unit location, estimated volume of floatables and gross debris removed, and the depth of sediment measured. Also note any apparent irregularities such as damaged components, blockages, or irregularly high or low water levels.
9. Securely replace the grate or lid.

Maintenance at a Glance

Inspection	<ul style="list-style-type: none"> - Regularly during first year of installation - Every 6 months after the first year of installation
Oil and Floatables Removal	<ul style="list-style-type: none"> - Once per year, with sediment removal - Following a spill in the drainage area
Sediment Removal	<ul style="list-style-type: none"> - Once per year or as needed - Following a spill in the drainage area

NOTE: For most clean outs the entire volume of liquid does not need to be removed from the manhole. Only remove the first few inches of oils and floatables from the water surface to reduce the total volume of liquid removed during a clean out.



First Defense® Installation Log

HYDRO INTERNATIONAL REFERENCE NUMBER:	
SITE NAME:	
SITE LOCATION:	
OWNER:	CONTRACTOR:
CONTACT NAME:	CONTACT NAME:
COMPANY NAME:	COMPANY NAME:
ADDRESS:	ADDRESS:
TELEPHONE:	TELEPHONE:
FAX:	FAX:

INSTALLATION DATE: / /

MODEL SIZE (CIRCLE ONE): [3-FT] [4-FT] [5-FT] [6-FT] [7-FT] [8-FT] [10-FT]

INLET (CIRCLE ALL THAT APPLY): GRATED INLET (CATCH BASIN) INLET PIPE (FLOW THROUGH)



First Defense[®] Inspection and Maintenance Log

Date	Initials	Depth of Floatables and Oils	Sediment Depth Measured	Volume of Sediment Removed	Site Activity and Comments



Stormwater Solutions

94 Hutchins Drive
Portland, ME 04102

Tel: (207) 756-6200

Fax: (207) 756-6212

stormwaterinquiry@hydro-int.com

www.hydro-int.com

Appendix 15 | Geotechnical Investigation Report by Kevin L. Patton, P.E.

KEVIN L. PATTON, P.E.
36 PATTON ROAD
NEWBURGH, N.Y. 12550
845 275-7732 PATTONGEOTECH.COM

CLIENT:	RDM Group	PROJECT:	Dewpoint Dolsontown
	1 International Drive, Suite 410		Town of Wawayanda, N.Y.
	Mahwah, NJ 07430	PROJ. No.:	21416
		DATE:	March 25, 2022

GEOTECHNICAL INVESTIGATION REPORT

Table of Contents

Section		Page
1.	PROJECT DESCRIPTION	2
2.	SOIL INVESTIGATION AND TEST RESULTS	3
2.1.	Soil Boring Blow Counts and Laboratory Data	4
2.2.	Subsurface Profile and Summary of Soil Conditions	6
3.	EVALUATION	7
3.1.	Subgrade Preparation	7
3.2.	Excavation	8
3.3.	Fill Materials and CLSM	8
3.4.	Fill Placement and Compaction	9
3.5.	Compaction Requirements	11
3.6.	Testing	12
3.7.	Geosynthetic Materials	12
4.	DESIGN VALUES AND RECOMMENDATIONS	14
4.1.	Bearing Capacity and Soil Pressure	14
4.2.	Control of Groundwater and Soil Gases	15
4.3.	Seismic and Expansive Properties	15
5.	NOTES AND LIMITATIONS	16

SOIL TECHNICAL NOTES

BORING LOCATIONS

SUBSURFACE PROFILE

SOIL BORING LOGS

LABORATORY TEST REPORTS

USDA SOIL REPORT DATA

1. PROJECT DESCRIPTION

This geotechnical investigation report was prepared for use in the design and construction of two new warehouses on two wooded lots, one on the south side of Dolsontown Road and the other across from it on the north side, as shown on the attached plan. Both lots are wooded and appear to have had past agricultural use, but no prior development; they are situated near the west end of a roughly ninety-foot high hill which is elongated northeast-to-southwest, cresting at an elevation of about 540 feet, approximately 750 feet northeast from the project area. Monhagen Brook skirts the project area, approaching it from the north, flowing through the northwest part of the north parcel, then south and east around the south parcel; the stream channel has a very gentle slope, and is at about 460 feet elevation where it crosses the north parcel.

The proposed south building has an approximately 125,000 square foot footprint, with a length of 590 feet east-to-west, parallel to the road, and a depth of 212 feet. Existing elevations range from about 515 feet near the northeast corner to 485 feet at the southeast corner and 477 feet along the west end. The proposed floor elevation was not provided; it is estimated to be about 495 feet, resulting in a nominal twenty-foot cut at the high end and an eighteen-foot fill at the low end. With the floor at this elevation the south warehouse could be built with the slab at finished grade around its entire perimeter, with a relatively steep slope (2H:1V) down to the building from the corner of Dolsontown Road and Caskey Lane, but it may be more practical to design the east half of the north wall and the north two-thirds of the east wall as retaining walls, with the building corner cut into the slope, with little change to the adjacent grades in that area.

The north building has proposed dimensions of 150 by 200 feet (30,000 square feet), with the short end parallel to Dolsontown Road. The existing elevations in the building area range from about 517 feet at the southeast corner to 480 feet at the northwest corner; a floor elevation of 490 feet was estimated for purposes of this report, resulting in a nominal 27-foot cut at the southeast corner and ten-foot fill at the northwest building corner. A retaining wall is proposed, to the northwest of the building, to allow development of the loading docks and truck apron on the west side of the building, which would most likely be cut into the hillside on the east side and the east part of the two ends.

The USDA Soil Survey indicates that the native topsoil type in the two project areas is Mardin gravelly silt loam, changing to Erie gravelly silt loam in the lower areas. These soils typically form over deep deposits of clayey glacial till, sometimes with significant sandy to gravelly layers, and sometimes with abundant cobbles and boulders. The soils encountered in the borings were generally consistent with the Soil Survey data, tending to be clayey to silty-clayey, with occasional boulders. No significant areas of fill were encountered. Bedrock appears to be deeper than the expected depths of excavation for the buildings.

2. SOIL INVESTIGATION AND TEST RESULTS

Prior to drilling the soil borings, test pits were excavated in proposed stormwater control areas downhill from both building areas; the results of that investigation were reported separately and are discussed below, in Section 2.2. Eight soil borings were drilled on April 21, 22, 25 and 26, by the hollow-stem auger method, using a track-mounted drill rig; borings B1 through B6 were drilled in the south building area, and B7 and B8 were drilled in the north building area. Drilling was performed by General Borings, Inc. of Prospect, Connecticut. The subsurface investigation was supervised and witnessed by Wyeth Patton, under the direction of Kevin Patton, P.E.

Soil sampling and testing in the borings were performed by the Standard Penetration Test (SPT,) using an Automatic Hammer, in accordance with ASTM D1586 (Standard Method for Penetration Test and Split-Barrel Sampling of Soils.) The SPT provides the Blow Count "N" Value, equal to the number of blows of the 140-pound steel hammer that were required to drive the 2-inch outside diameter split-spoon sampling tube into the soil, over a twelve-inch increment. Soil samples are also recovered by this method, and additional tests were performed in the field and lab, as noted on the soil boring log, using a hand penetrometer to test bearing capacity. Laboratory testing was performed on representative soil samples, for moisture content, particle size distribution and Atterberg Limits, and one sample was tested for unit weight (density.) USCS classifications of the soil, per ASTM D2487 and D2488, are provided on the logs and on the subsurface profile drawing.

2.1. Soil Boring Blow Count and Laboratory Data

Field Blow Count Values, N								
	B1	B2	B3	B4	B5	B6	B7	B8
Elevation±:	515	509	495	494	510	486	504	497
Depth, ft.: 1	15	4	8	8	5	5	4	6
3		21	23	27	29	22	19	29
6	36	50/1"	24	29	26	43	42	26
8			22	31	49	43	50/3"	49
11	50/3"	50/1"	28	63	69	48	36	38
16	50/2"	--	79	50	50/2"	50/4"	50/1"	37
21		50/1"	53	50/4"	50/5"	86	50/6"	50/6"
26			88/11"	50/4"	50/2"			
31			50/2"	71	50/5"			
Auger Refusal, ft	19.0	23.5					23.5	
Cored:		15-20						

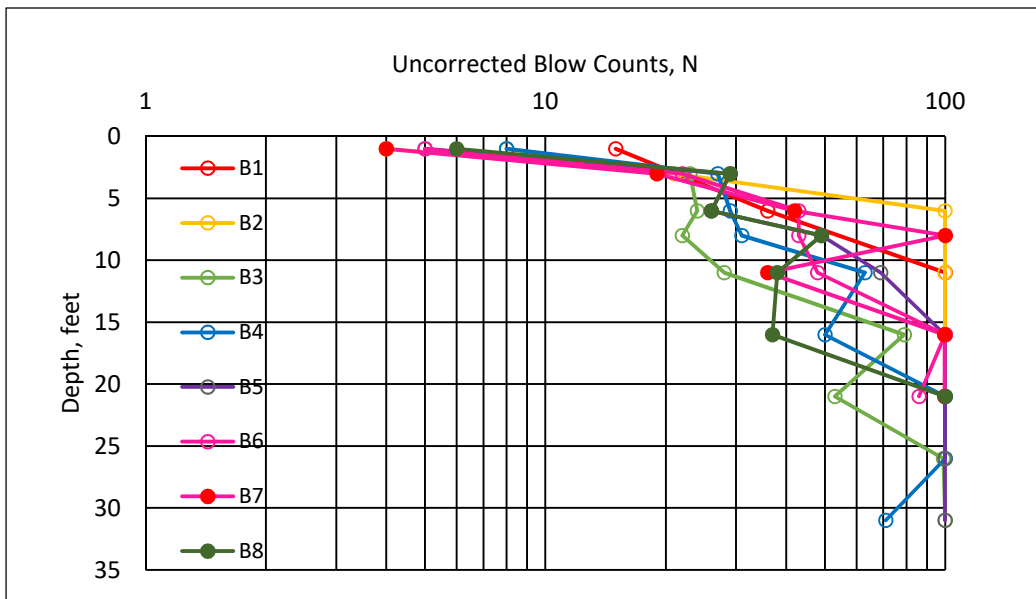

Natural Moisture Content, Percent								
Depth, feet	B1	B2	B3	B4	B5	B6	B7	B8
3		11.4	12.2		8.0	11.9	11.8	8.9
6	12.5		11.8	11.6	11.2	8.8	11.8	10.3
8			14.2	11.9	11.2	10.5		
11	10.9				9.8	11.6	13.1	
16			9.0	9.9	7.8	7.6	9.3	9.2
21		9.3	8.3	13.1	8.8	9.6	3.7	
26			11.0					
31				11.8				

SOIL TEXTURE			
Particle Size Analysis			
Sample		B5-S9	B8-S4
Depth		31 feet	8 feet
Type		Gray Till	Brown Till
USCS Class		CL-ML, Sandy Silty Clay	SC, Clayey Sand with Gravel
Sieve Size	mm	Percent Passing by Weight	
¾"	19.0	100	100
#4	4.75	90	81
#10	2.00	84	73
#40	0.425	78	64
#200	0.075	68	49
Hydrometer	0.050	65	46
	0.005	26	25
	0.002	15	17
Atterberg Limits			
Liquid Limit		20	23
Plastic Limit		15	15
Plasticity Index		5	8

Soil Density / Unit Weight	
Sample	B3-S5
Depth	11 feet
Type	Brown silty clay till
Moist Density, pcf	140
Dry Density, pcf	123
Percent Moisture	13.8

The Standard Penetration Test results (blow counts) indicated loose conditions close to the surface, then medium-dense soil to about five feet depth; from five to twelve feet the soil was medium-dense to very dense, from twelve to eighteen feet it was dense to very dense, and below eighteen feet depth it was very dense.

The moisture contents of the samples were generally at the low end of the normal range for the soil types tested, despite many of the samples being in a very moist to wet condition. These moisture contents, mostly in the eight percent to fourteen percent range, reflect the very densely-consolidated nature of the soil, as indicated by the blow counts, the penetrometer measurements and the density test which was performed on a random, representative sample of the brown till. This sample's moist density was about ten pounds per cubic foot heavier than 'normal' soil and its moisture content of 13.8 percent indicates a very moist condition, although the sample did not appear to be wet.

The particle size analyses and Atterberg Limits tests were performed on representative samples of the brown and the gray till; these samples were dense to very dense, and were composed of a well-graded mix of sand, silt and clay sizes with minor gravel. The sample of gray till contained about two-thirds silt and clay, twenty percent sand and ten percent gravel; the brown till sample was composed of about one half

silt and clay, thirty percent sand and twenty percent gravel, and while technically classified as 'SC, clayey sand with gravel,' if the sample had one percent additional passing the #200 sieve it would be classified as 'CL, Sandy Clay.' Note that the split-spoon sampling method which was used to collect the samples excludes particles that are medium gravel-size or larger. The gravel fraction may be under-represented; cobbles and boulders are also present in the soil but are not represented by the tests. The samples had similar Atterberg Limits results, indicating a silty clay to lean clay composition with a low potential for expansion.

2.2. Subsurface Profile and Summary of Soil Conditions

Subsurface conditions encountered in the borings are described in the boring logs and are summarized in the drawing attached to this report. The soils in both building areas consisted of layered glacial till; at the south building the till encountered in the cut portion of the building was mostly composed of silty clay and clay, with little to some sand and traces to little gravel. The borings in the fill portion of the south building also encountered these soils, inter-layered with till with a sandy silt to silty sand composition. Boulders were encountered in three of the six borings in this area. The soils were mostly moist to very moist, with wet zones of perched groundwater at varying depths, however the actual moisture content was relatively low, due to the high degree of consolidation and low porosity of the soil. The till encountered in the borings in the north building area were similar to the deeper soils in the south building area, and included layers of significantly more sandy to gravelly till with little silt. The soils at the north building were mostly in a moist condition and were wet near the surface; occasional boulders were also present.

Test Pits excavated during the stormwater investigation also encountered layered glacial till, with layers of silty, clayey, silty-sandy and clayey-sandy till downhill from both building areas. These soils were mostly in a very moist to wet condition, and the stabilized groundwater depths were determined to be less than thirty inches from the surface at most locations. Occasional small boulders were also encountered in these test pits, most of which were excavated to eight feet depth.

Bedrock appears to be sufficiently deep that it will not be encountered in the building excavations. Due to time limitations, no boring was drilled at high point in the north building (elevation 516±,) however all of the borings were drilled to depths of twenty to thirty feet without encountering bedrock, and the hill on which the project is situated is believed to be a drumlin or drumlin-like glacial deposit composed mostly of till, with bedrock at relatively great depth.

3. EVALUATION

3.1. Subgrade Preparation

The conditions encountered in the investigation were evaluated for their impacts on construction methods, structural-geotechnical design, and long-term performance. The evaluation indicates that the subgrade conditions throughout the two proposed building areas are suitable for the use of shallow spread footing foundations and slabs-on-grade, subject to performing the required subgrade preparation operations, as described below.

Remove all existing topsoil, soft subsoil, stumps and large roots from the subgrade surface, in all building foundation areas, and to at least one foot beyond the building for each foot of fill to be placed in fill areas. Excavate to at least twelve inches below the original natural grade, and to the top of stiff, unyielding soil. Use excavation methods that minimize disturbance of the final subgrade surface. Compact the surface as needed to consolidate any soil that was loosened during excavation. Remove any pockets or small zones of unsuitable materials that are encountered, and replace them with controlled compacted fill. Contact the Engineer prior to performing any significant extra excavation. Where stumps or boulders are removed, or where other over-excavation work is performed to prepare subgrade areas, the sides of the excavation shall be trimmed back to stable soil as each lift is placed; as the backfill is compacted, extra care shall be taken to ensure thorough compaction where the edges of each lift meet the sides of the excavation. Where deficient soil is removed from below footing locations, the remediated area shall extend at least one foot out from the footing per foot of depth (1 to 1 splay.) Refer to the Fill Placement and Compaction section of this report for additional comments regarding subgrade preparation for areas of site-borrow fill placement.

If bedrock is encountered and excavation is performed by ripping, hammering and/or blasting, remove the rock to an approximately level and uniform elevation, with a slope of ten percent or less in areas below footings. If the rock subgrade surface has open fractures, level and seat the surface by tracking back-and-forth over it with a bulldozer or excavator, or spade it with the excavator bucket in tight areas, then compact the surface with several passes of a vibratory trench roller or a single-drum soil roller. A layer up to four inches thick of Structural Fill or ¾-inch to 1½-inch crushed stone may be placed over the rock surface to facilitate compaction. Remove loose rock from vertical steps in the foundation.

Footings may bear directly on the prepared soil or rock subgrade, or on controlled compacted fill placed over the subgrade. Footing bearing surfaces shall be free from frost, mud and loose soil or standing water, when concrete is placed. Rock surfaces should be thoroughly moistened prior to placing concrete. Where fine-grained native soil is present at the bearing elevation, a layer up to four inches thick of Structural Fill may be placed in the footing bottom to protect the soil surface, after properly preparing the surface to a level and stable condition. This layer shall be thoroughly compacted with a vibratory plate tamper or roller, and its surface shall not extend above the design bearing elevation.

In the slab areas, select fill material should be used for the final two feet of fill below the slab base. Structural Fill or similar granular material should be used in those areas, to protect the subgrade prior to slab placement, especially if the slab will be placed by ready-mix trucks driving over the surface.

3.2. Excavation

The native soils may be excavated using conventional heavy equipment, such as tracked excavators and bulldozers. Scraper pans may be used; the pans will likely need a bulldozer pusher when cutting into the borrow area surface; moderate interference from boulders should be expected. Rollers, wheel loaders and other heavy equipment should be sized appropriately for the subgrade conditions. Traffic from dump trucks, pans and similar heavy vehicles should be minimized on the exposed surface of the subgrade and on compacted fine-grained fills. Little or no rock excavation is expected within the building areas.

The investigation indicates that the soils which will be encountered in the building excavations are likely to predominately be OSHA Type A, requiring a minimum slope of 0.75-to-1 in shallow excavations, with benching permitted. Soil types for excavation requirements must be confirmed by a qualified representative of the Contractor during construction. In most locations, shoring of excavations should not be required, as there appears to be sufficient distance from the property line to the estimated limits of the foundation work area to allow the use of conventional excavation slopes. Shoring may be required near the southeast corner of the north building, depending on the actual depth of the cut in this area. The design of any necessary shoring or other support-of-excavation is the responsibility of the Contractor and is not included in this report.

Groundwater seepage rates in the building excavations are expected to be slow, but will likely be persistent, at least during wet seasons, and occasional zones of concentrated seepage may be encountered from zones of perched water. Groundwater seepage and stormwater should be removed promptly from the excavations, and the groundwater elevation should be maintained at least one foot below the surface in foundation construction areas. When dewatering excavations, the water level should be drawn down at a controlled rate to minimize sloughing, allowing the water to drain from the soil in the sides of the excavation.

3.3. Fill Materials and CLSM

Soils excavated from the site are expected to be of fair quality for re-use as fill and backfill for foundations, slabs and pavement areas. The native clayey soils can be used as fill, but are moisture-sensitive and are typically difficult to work with, especially when the weather is other than warm and dry. The investigation did indicate, however, that most of the potential borrow soils are only slightly wetter than optimum moisture, and if excavated, spread and compacted during favorable weather (drying conditions) the work can be performed relatively efficiently. Boulders and large cobbles must be removed from the borrow fill. Clumps of clayey soil larger than two-thirds the lift thickness must be broken up.

If imported fill is used below foundations and slabs, it shall be of a quality at least equal to that of the site-borrow soil, and if possible should consist of granular material, e.g. imported Structural Fill, which shall be good-quality bank-run sand and gravel or crushed stone, and should comply with the gradation limits below. Structural Fill may also be used as foundation backfill. Structural Fill HD (Heavy Duty) should be used in areas to be protected from heavy construction traffic and where subgrade stabilization and/or enhanced drainage is needed.

All fill materials shall be composed of sound, durable particles, shall be free from frost or snow, garbage, construction debris or other deleterious material, and shall be substantially free from organic matter and

roots. Recycled crushed concrete and masonry from a registered source may be acceptable for some applications, subject to approval by the Designer of Record. Fill shall not be placed over frozen or unstable soil, unless approved by the Engineer.

Sieve size		Structural Fill	Structural Fill HD
Inch	mm	Percent Passing by Weight	
4"	100	100	100
1½"	37.5	50-100	50-95
#4	4.75	20-70	20-50
#40	0.425	5-40	5-25
#200	0.075	0-30	0-10
Plasticity Index		6 max.	Non-plastic

CLSM (Controlled Low-Strength Material, aka flowable fill or k-crete,) may be used under footings and foundations when specifically approved by the Engineer, and may also be used to backfill trenches or other excavations, typically where rapid fill placement is required, fill areas are narrow, or the use of conventional compaction methods is not practical. For support of footings, a CLSM mix consisting of sand, cement and water, with a 56-day compressive strength of 75 to 200 psi, is appropriate. CLSM may produce high fluid pressures during placement, and caution must be used for placements against foundation walls, near unbraced cuts, etc. Pipes or tanks can also float if not properly restrained during placement. CLSM should not be placed against unprotected aluminum; CLSM containing flyash should not be used in contact with cast iron or ductile iron. Hardened CLSM masses may also adversely affect groundwater flow, possibly causing erosion under or along the CLSM, particularly in sloping trenches.

Other Fill Materials:

- Crushed stone base course for slabs-on-grade should consist of ASTM C33 #56 or #57 stone (¾- to ¾-inch size,) or as required by the slab system design.
- Crushed stone or gravel for footing drains should consist of ASTM C33 #5, #56 or #57 stone (¾-inch or ¾-¾-inch size.)
- Well-graded granular subbase material (NYSDOT Item 733-04 'Item 4' or similar) should be used under sidewalks and exterior slabs.

3.4. Fill Placement and Compaction

Soil surfaces, including the surfaces of previously-placed fill materials, shall be prepared to a stiff and essentially unyielding condition prior to placing each new lift of fill. Bedrock surfaces to receive fill shall be free from voids or loose areas and the rock surface shall be free from large loose pieces of stone. Use mid-size equipment to compact the site-borrow fill material. Vibratory trench rollers, and single-drum soil rollers with a nominal size of three to seven tons, are appropriate for the observed site conditions. Larger rollers may be used when compacting well-graded granular fill over essentially unyielding surfaces. In areas with limited access, vibratory plate tampers or jumping-jack tampers may be used. Avoid over-compacting the soil in landscaped areas.

Fill shall be placed in controlled lifts, with each lift compacted to the required density at a moisture content close to optimum moisture, as determined by ASTM D1557. When the moisture content of the fill is within

two percent of optimum, fill may be placed in lifts with compacted thicknesses of up to twelve inches. If the moisture content is two to three percent from optimum, reduce the maximum thickness to eight inches, and if it is more than three percent from optimum, discontinue compaction. Use a reduced lift thickness if required to obtain the specified percent compaction and when using small compaction equipment. If the fill is too dry, mix in water as the fill is spread; surface watering is typically ineffective.

Where fill will be placed against slopes, bench the fill into the slope to create a stair-step interface, for improved stability and groundwater control. Lightly scarify the surface of the existing soil prior to placing the fill, and key the fill into the subgrade at the toe of the slope. When the fill is more than five feet high against a slope of twenty percent or more, the key should be at least two feet deep and ten feet wide.

For cut slopes and fill slopes with a height of thirty feet or more, and a slope of 33 percent or greater (one in three,) terraces should be provided at vertical intervals of thirty feet or less, to control drainage and debris. The terraces should be at least six feet wide, but where more than one is required, the terrace nearest mid-height of the slope should have a width of at least twelve feet, for maintenance access. Drainage swales shall be provided on terraces. Refer to the optional Appendix J of the Building Code for additional details.

Pipe bedding in utility trenches may act as groundwater flow routes during or after construction. Use well-graded bedding, or interrupt coarse granular bedding with occasional zones of compatible lower-permeability soil to control minor seepage. Avoid the use of excessively coarse pipe bedding material that can allow fines to wash in from the surrounding soil. Contact the Engineer if excessive groundwater is encountered.

Open-graded stone base course material for slabs-on-grade should be graded level and seated with one or more compaction passes, to help resist displacement during slab area preparation and concrete placement.

It is expected that the native clayey glacial till will be used for the majority of the fill in the building areas. Careful preparation, placement and compaction methods must be employed, and the fill section must be properly designed.

- Prepare the fill by drying it to a somewhat crumbly consistency, then thoroughly break up the soil clods so that they are no larger than two-thirds of the lift thickness (e.g. smaller than eight inches for a twelve-inch thick lift.)
- Mix and spread the fill so that the larger clods are well-mixed with finer pulverized soil; remove boulders during preparation and placement. Condition the fill as needed to reach the proper compaction moisture content, mixing the fill so that the moisture is uniform throughout the lift thickness.
- Re-work any 'clod clusters,' where the fill is lacking in fines, to a well-graded condition, by crushing, mixing and/or adding fine fill material.
- Compact the clay fill with a mid-size single-drum vibratory roller, or with a dual-drum trench roller where access is limited; a heavy roller will tend to produce rutting, and a light roller will not adequately compact the soil. A roller with a sheep's-foot or tamping foot drum is preferred, both because it tends to knead and compact the soil clods, and because the compacted surface promotes the dispersed vertical drainage of water infiltration, versus the surface produced by a smooth-drum roller, which promotes lateral seepage movement, potentially causing local saturation and the creation of soft spots.

- Drainage must be provided at the bottom of any significant fill sections, to minimize water accumulation in the base of the clay, which can cause softening and settlement. A layer of granular fill, such as 'Structural Fill,' at least one foot thick, is typically sufficient, provided the granular layer is free to drain laterally and/or vertically. Where the vertical drainage into a clay subgrade is to be provided, trim the clay subgrade carefully to a suitable surface without disturbance, and do not compact the clay prior to placing the granular fill; this will promote infiltration, but the rate may still be slow.
- The top of the fill must also be provided with proper drainage, particularly below parking lots, lawns, and in other areas of surface water infiltration. The final lift of clay fill should be at least two feet below the proposed top-of-pavement elevation in paved areas, to provide sufficient depth for drainage and for protection of the clay subgrade during construction and paving. In landscaped areas, the top of the clay fill should also be at least two feet deep, to allow for a sufficient thickness of fill with a suitable moisture capacity to support vegetation.
- The top of the clay fill must be carefully graded to avoid low spots, where surface water infiltration can accumulate; it should be pitched gently toward underdrains or other outlets, and not made perfectly level.
- Installation of a layer of geotextile between the top of the clay fill and the pavement subbase and landscaping fill is recommended. The geotextile will promote the retention of water from surface infiltration in the pavement base and drainage layers and in the landscaping, and will reduce concentrated infiltration into the clay fill.
- Surface water infiltration in the shallow fill materials and in the clay fill will tend to seek curbs, utility trenches and similar discontinuities, and subsurface drainage should be provided from these features; where water concentration along utilities needs to be minimized, use well-graded bedding material.
- Embankment slopes constructed with clay fill should be built slightly wide, then trimmed back, to allow thorough compaction near the edge. The fill placed in the outer zone (six feet wide, or one third of the fill height above, whichever is greater) should be compacted at a moisture content no more than one percent above optimum, leaving the soil clods slightly crumbly and creating some initial lateral permeability.
- The surfaces of embankment slopes should be scarified prior to placing topsoil, and small benches or one- to two-foot wide steps should be provided at frequent intervals to protect against sliding of the topsoil. The topsoil should be well-graded and relatively free-draining for erosion resistance, and should be placed at the minimum required thickness when the slope is steeper than three-on-one.

3.5. Compaction Requirements

Compact each lift of fill supporting slabs or foundations with at least six one-way compaction passes, even if the required compaction percentage is obtained with fewer passes. Each compaction pass shall be made at a slow walking speed (less than four feet per second,) with the equipment passing completely over all areas of the fill. Fill materials shall be compacted to at least the following percentage of the ASTM D1557 maximum dry density. For coarse-graded fill materials with more than thirty percent retained on the 3/4-inch sieve, the ASTM D4253 Maximum Index Density test may be substituted for the D1557 test.

Minimum Percent Compaction	
Location	Minimum Percent
Below footings, foundations and slabs	95
Exterior Foundation Backfill in Landscaped Areas	90

3.6. Testing

The prepared subgrade shall be inspected to verify that it has been prepared in conformance with the requirements of this report, prior to placing fill. Compaction testing is required by Code for each lift of fill supporting foundations, and testing shall be performed while the work is in progress. Recommended test procedures and frequencies are provided below.

PROOF-ROLLING: Proof-rolling of the prepared subgrade is not required, but may be performed to determine the limits of a soft area. Use an appropriately-sized vehicle, to avoid damaging wet and/or fine-grained, but otherwise acceptable soils. Observe the effects of the moving roller; if the soil exhibits excessive deflection, rutting or cracking, additional excavation or drying of the subgrade may be required.

BEARING CAPACITY: The prepared subgrade surface shall be free from loose material and shall be in a dense and unyielding condition; if this condition is not encountered at the design bearing elevation, testing shall be performed with a Static Cone Penetrometer or equivalent device, and the design bearing capacity shall be obtained within 3 inches of the surface in footing excavations. The soil throughout the foundation area shall be probed thoroughly to check for soft spots. If the bearing capacity tests are acceptable, the soil is undisturbed, is free from organics and is densely-consolidated, and if the observed yielding conditions are not due to the presence of loose or deficient soils, the subgrade may be accepted.

COMPACTION TESTING: Compaction tests of fill and backfill supporting foundations or slabs-on-grade should be performed in at least three representative locations for each lift, and in at least one location per 2500 square feet of fill surface. Compaction tests should be performed with a nuclear moisture-density gauge, per ASTM Test Method D6938, unless otherwise approved. Required percent compaction values are provided above.

CLSM: When flowable fill is used to support footings or foundations, at least one set of three 6x12-inch test cylinders shall be cast from each day's placement, per ASTM D4832. Test the cylinders for unit weight and for compliance with the specified strength requirements. Cast additional cylinders if early tests are needed.

3.7. Geosynthetic Materials

Geosynthetic materials are expected be used for reinforcement and drainage applications at the site on an as-needed basis, or where required by Code, such as for footing drains. Geosynthetic materials shall be installed over a smooth and evenly shaped subgrade, to avoid 'tenting' of the material over voids or high points. The geosynthetic shall be installed substantially free from wrinkles, and fill material shall be placed and spread in a manner which pushes the wrinkles out but which does not otherwise displace the geosynthetic material. Vehicles shall not drive on the exposed geosynthetics. The following material types are recommended, with typical examples of suitable products.

Drainage Separation: For footing drains and similar applications, a woven drainage geotextile with at least 4% open area, with an apparent opening size of 0.21mm (#70) or smaller, should be installed between the native soils and open-graded drainage zones. A suitable product is Carthage Mills "Carthage 6%." Non-woven geotextiles are not recommended for use in this application, due to the presence of fine particles in the native soil that will tend to clog the fabric. If stone drains are installed in areas of fine sand or cohesionless silt, provide a zone of clean sand at least three inches thick between the geotextile and the soil.

Subgrade Reinforcement: Typically, a woven reinforcing geotextile such as TenCate Mirafi 600X should be used where needed to improve the stability of soft subgrade soils. Geogrids may be used instead of woven geotextiles, especially if free drainage is desired. A minimum of twelve inches of granular fill cover is typically required to mobilize the strength of the reinforcing geosynthetic. Woven reinforcement geotextile will usually act as an infiltration barrier when installed in a continuous horizontal layer, and non-woven separation geotextile may also work as a barrier; this may or may not be desirable, depending on the installation location and conditions.

Subgrade Separation: Where fines from the subgrade may infiltrate into an overlying granular layer, and strengthening of the subgrade and free vertical drainage are not required, a non-woven geotextile such as Mirafi S600 or 160N should be used.

4. DESIGN VALUES AND RECOMMENDATIONS

Soil engineering properties and recommendations for design are provided in this section; additional important design considerations are also discussed in the other sections of this report. The design values assume that the building will be supported by a conventional spread footing foundation with slab-on-grade floor, as described in the previous sections, and will be provided with proper drainage.

4.1. Bearing Capacity and Soil Pressure

Allowable Bearing Capacity, q_a		
	Cut Areas	Fill Areas
Footings bearing at least 42 inches below finished grade, with a minimum width of 24 inches	4000 psf	3000 psf
Footings bearing at least 24 inches below finished grade, minimum width as noted	4000 psf 24" min.	3000 psf 60" min.
Minor Footings bearing at least 12 inches below finished grade, with a minimum width of 12 inches	2500 psf	1500 psf

Soil Properties	Native Soils
Soil Moist Density, γ , lbs/cu ft	140
Effective Internal Angle of Friction, ϕ	32°
Coefficient of Friction (vs. concrete)	0.40
Coefficient of Active Earth Pressure, k_a	0.31
Coefficient of Passive Earth Pressure, k_p	3.25
Coefficient of At-Rest Earth Pressure, k_o	0.47
Lateral Bearing Capacity (psf per ft below grade)	225
Modulus of Subgrade Reaction, k , psi per inch	200

Two bearing capacity values are provided, one for the in-situ glacial till soils and one for footings bearing on fill composed of this soil. It is recommended that the footings be designed following one of three strategies:

- Method 1. Design all footings for the lower (fill area) bearing capacity.
- Method 2. Design the footings for the most of the cut area for 4000 psf bearing. Design the footings in the fill area and in the last adjacent column bays of the cut area for 3000 psf bearing capacity.
- Method 3. Design all footings for the higher (cut area) bearing capacity. In the fill area, the final 24 inches of fill below the foundation shall consist of Structural Fill; this zone of granular fill shall extend at least 24 inches beyond the edges of the footings.

Footings subject to frost shall bear at least 42 inches below finished grade, or shall be otherwise protected from frost. Bearing elevations of footings shall be established such that a line drawn between the bottoms of two adjacent footings is not steeper than 30 degrees between the closest points on the footings. (Slope of 1 vertical to 1.75 horizontal.)

Up to one inch of settlement and 3/4-inch of differential settlement should be anticipated for the new foundation during construction, due to normal elastic compression of the soils below the footings, however in cut areas the actual settlement is expected to be one quarter inch or less. Where clay fill is placed in the recommended manner, an additional one quarter inch to one half inch of settlement should be expected per five feet of fill thickness below the footings.

4.2. Control of Groundwater and Soil Gases

Minor groundwater seepage should be expected in excavations and below-grade areas during and after construction. Conventional damp-proofing, including placement of slabs-on-grade over a vapor barrier and an open-graded stone base course, and installation of conventional footing drains are appropriate to control water seepage around the foundation walls of the building. The borings do not indicate that vertical drainage panels or a zone of sand or gravel outside the walls (where they will be backfilled above the slab elevation) will be necessary for seepage control, but this additional drainage is of relatively low cost and its inclusion should be considered, to protect against unexpected seepage or future changed conditions. Stormwater infiltration from the parking and landscaped area should be diverted away from the building.

Soil gases that could normally be expected to impact the structure are water vapor and radon. Thorough foundation damp-proofing, as noted above, placement of dense concrete in slabs-on-grade, (low water-to-cementitious ratio, thoroughly consolidated,) and sealing of all wall-to-slab joints, concrete cracks, pipe penetrations, drainage sumps, etc. are usually effective in controlling transmission of these gases to interior spaces. If an open-graded base course is used under the slab, a passive vapor mitigation system can be included, using small-diameter PVC pipes. The potential for these gases to adversely impact the use of the building is estimated to be low, if the above recommended practices are used, and normal interior ventilation is provided.

4.3. Seismic and Expansive Properties

Seismic Design Values: The Seismic Site Class and Seismic Design Category for the proposed construction were determined per section 1613 of the New York State Building Code and ASCE 7-16. Seismic values for the site were obtained from the current database maintained by the Applied Technology Council, Redwood City, Cal., and are consistent with the published maps in the Building Code. Values were as follow.

Occupancy Category	I/II/III	
Seismic Site Class	C - Very Dense Soil and Soft Rock	
IBC Seismic Design Category	SDC - B	
Maximum Acceleration	0.2 sec S_S	0.212 g
	1.0 sec S_1	0.054 g
Maximum Spectral Response Acceleration	0.2 sec S_{MS}	0.275 g
	1.0 sec S_{M1}	0.082 g
5% Damped Spectral Response	0.2 sec S_{DS}	0.184 g
	1.0 sec S_{D1}	0.054 g

The seismic design values are based on the “risk adjusted maximum probable earthquake.” These are not the maximum values that *could* occur, they are values that are not likely to be exceeded during the service life of a typical structure.

Liquefaction Potential: The soils encountered in the investigation have negligible liquefaction susceptibility. The soils are dense and do not have texture/permeability combinations that are associated with loss of shear strength during anticipated seismic events. No special mitigation measures are required.

Expansive Soils and Frost Heave: The soils encountered in the investigation have a very low potential for expansion due to shrinking and swelling resulting from moisture changes. This behavior is typically associated with high-plasticity silt and clay soils. Physical testing and qualitative examination indicate that the soil properties do not meet the criteria for potentially expansive soils as defined in section 1803.5.3 of the Code. No mitigation measures are required. The on-site soils are moderately to highly susceptible to frost heave. Frost heave can be minimized by providing good drainage and by thoroughly compacting the soil. Well-graded granular fill should be used in areas where frost heave could result in damage.

5. NOTES AND LIMITATIONS

Please see the attached pages for additional information. Subsurface conditions encountered during construction shall be compared to the soil boring logs and this report; any significant variations from anticipated conditions must be evaluated for their effect on the design. This report summarizes the results of a limited investigation and does not purport to predict every variation in subsurface conditions. Elevations, slopes, contours, project layout and similar or related data provided in this report were interpreted from the drawings, from field data or from other information which was provided, unless otherwise noted.

This geotechnical investigation was conducted to evaluate the engineering properties of the soils at the site, to aid in the design of the proposed work. The investigation did not include evaluation of the potential effects of the proposed construction on other properties, nor did it include inspection of, or sampling for, items of environmental concern such as the presence of soil contaminants or of regulated wetlands, and did not include review of local zoning regulations, codes, floodplain boundaries or similar matters, unless specifically referenced in the report. This investigation was conducted solely for the use of the Client, the Client’s Project Designers and Agents and the Authorities Having Jurisdiction; this report should not be used by others, nor for any use other than its stated purpose, without contacting the Engineer. Any such use is solely at the user’s risk.

Prepared by Kevin L. Patton, P.E.



The image shows a blue circular professional seal for Kevin L. Patton, a Licensed Professional Engineer in the State of New York. The seal contains the text "LICENSED PROFESSIONAL ENGINEER", "KEVIN L. PATTON", "May 25, 2020", and "STATE OF NEW YORK". The license number "072197" is also visible. A handwritten signature in black ink is written across the seal.

The USCS (Unified Soil Classification System) was used to classify the soils in this report. The USCS is described in ASTM D2487 (laboratory test method) and D2488 (visual-manual method.) The USCS classification gives a 'Group Symbol' and 'Group Name' based on particle size distribution (gradation,) clay properties (Atterberg Limits) and basic composition (mineral or organic.)

USCS Soil Classes

Soils with less than 5% passing the #200 sieve:

GW, GP, SW, SP – Well-graded gravel, Poorly-graded gravel, Well-graded sand, Poorly-graded sand.

Soils with 12% to 50% passing the #200 sieve:

GC, GM, GC-GM, SC, SM, SC-SM – Clayey gravel, Silty gravel, Silty clayey gravel, Clayey sand, Silty sand, Silty clayey sand.

Soils with 5% to 12% passing the #200 sieve use a dual symbol, such as SW-SC (Clayey well-graded sand.)

Soils with more than 50% passing the #200 sieve:

CL-ML, ML, CL, MH, CH, OL, OH – Silty clay, Silt, Lean clay, Elastic silt, Fat clay, Organic silt, Organic clay.

Highly organic soils:

PT – Peat.

The soil group name is modified with the term 'with sand' or 'with gravel' added if the soil contains more than 15% of these materials; clays and silts with 30% or more plus-#200 material are described as 'sandy' or 'gravelly' (whichever is predominate.) Examples – GM, Silty gravel with sand; CL, Gravelly lean clay.

Particle size	Fine- and Coarse-grained Soils	Atterberg Limits
>12" (300mm) Boulders 12" to 3" (300-75mm) Cobbles 3" to #4 (75-4.75mm) Gravel #4 to #200 (4.75-0.075mm) Sand <#200 (0.075mm) Silt & Clay	The USCS classification applies to the material smaller than the 3-inch sieve. 'Fine-Grained Soils' (silts and clays) have more than 50% passing the #200 sieve and are classified by their Atterberg Limits.	Test is performed on the clay, silt and fine sand fraction of the soil: Liquid Limit (LL) – moisture content (%) at which soil becomes very soft. Plastic Limit (PL) – moisture content at which soil crumbles. Plasticity Index (PI) = LL minus PL
Organic Soils Highly organic soils such as peat are visually classified. Partly organic soils, with a mix of organic and mineral matter, are classified visually and by Atterberg Limits tests.	'Coarse-Grained Soils' (sands and gravels) have less than 50% passing the #200 sieve. When more than 50% of the plus-200 material is retained on the #4 sieve the general soil type is gravel, and if more than 50% is finer than the #4 sieve, it is sand.	Higher PI values may indicate reduced permeability and increased drying shrinkage.
Moisture Content Moisture is visually estimated and samples are usually tested. Soil moisture capacity varies with texture and compaction. Typical examples: GW, moist at 3%, saturated at 9% SP, moist at 6%, saturated at 20%. CL, moist at 12%, saturated at 33%.	Clean coarse-grained soils are classified as well-graded (Classes GW, SW) or poorly-graded (GP, SP.) Well-graded soils have a wider range of sizes and are typically more stable. Poorly-graded soils are usually more permeable.	LL > 50 indicates soil with a higher potential to shrink and swell due to changing moisture content. Silts have lower PI values, and behave like very fine sand; most silts also contain some clay. Behavior of clays is partly controlled by electrochemical forces and varies among the several clay minerals.
Color	Relative Quantities	USDA Soil Classification
Soil color sometimes indicates groundwater conditions, with subdued colors below the water table and mottled (mixed) colors in the zone of seasonal water table fluctuation. Color changes tend to be more prominent in fine-grained soils.	Estimated percentages in descriptions: <5% - Trace 5-10% - Traces 10-25% - Little 25-35% - Some 'And' - Approx. equal amounts 'Few' - <10% (cobbles and boulders)	USDA classifications are based on the relative amounts of sand, silt and clay in the soil fraction passing the #10 (2mm) sieve. 'Gravelly' indicates more than 15% of #10 to 3" size. 'Channery' indicates 15 to 35% thin flat pieces up to 6" long.

GENERALIZED SUBSURFACE PROFILE

NO HORIZONTAL SCALE.
USCS SOIL CLASSIFICATIONS ARE IN BRACKETS.

IN GENERAL, RED PATTERNS INDICATE RELATIVELY CLEAN SANDY OR GRAVELLY SOILS,
PURPLE PATTERNS INDICATE SOILS WITH SIGNIFICANT CLAY CONTENT AND ORANGE
PATTERNS INDICATE SOILS WITH A SIGNIFICANT SILT CONTENT.

● BOULDER(S)

THESE SECTIONS ARE GENERALIZED REPRESENTATIONS OF THE SUBSURFACE PROFILE,
BASED ON THE SUBSURFACE EXPLORATION DATA, OBSERVATIONS, RESEARCH, AND OTHER
RELEVANT INFORMATION. THE SOILS INFORMATION PRESENTED HEREIN SHOULD BE
INTERPRETED IN CONJUNCTION WITH THE INFORMATION FROM THE BORING LOGS AND THE
GEOTECHNICAL INVESTIGATION REPORT. SITE CONDITIONS MAY DIFFER FROM THOSE
ENCOUNTERED AT THE BORING LOCATIONS.

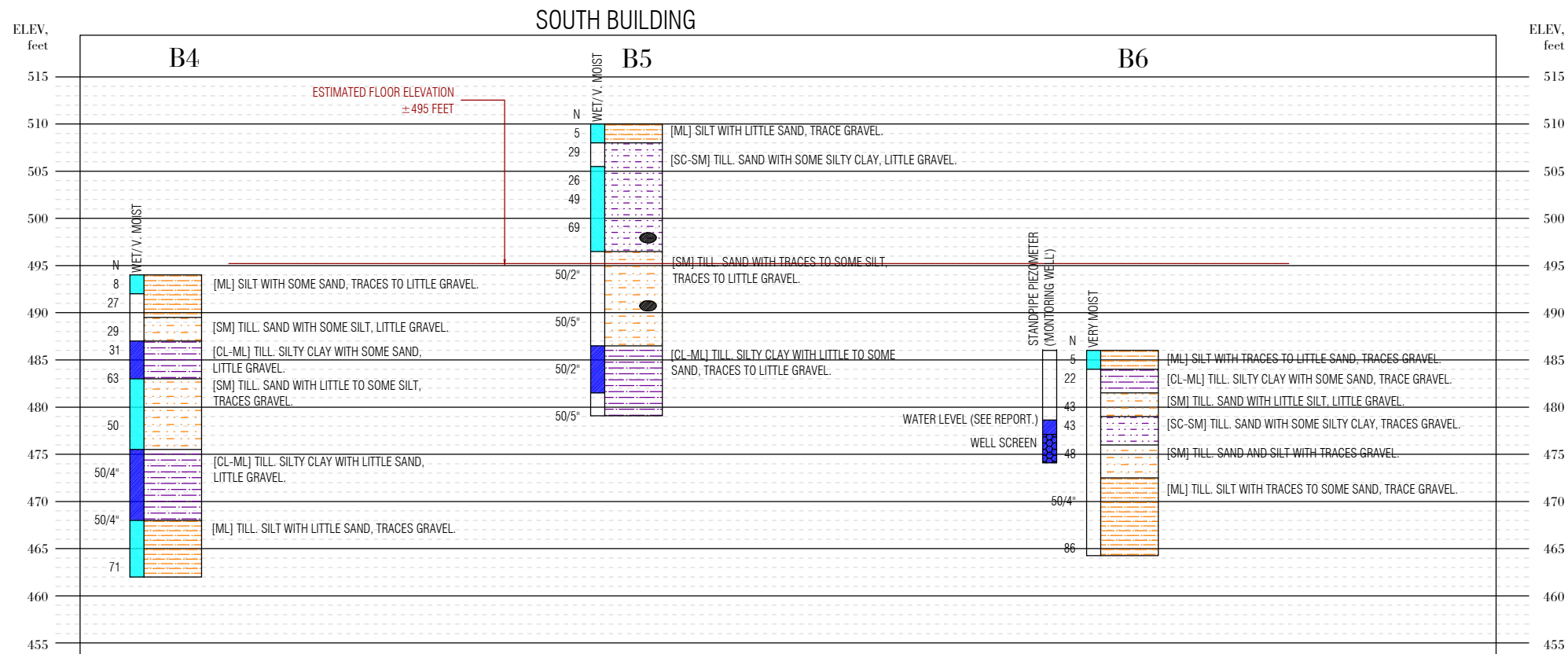
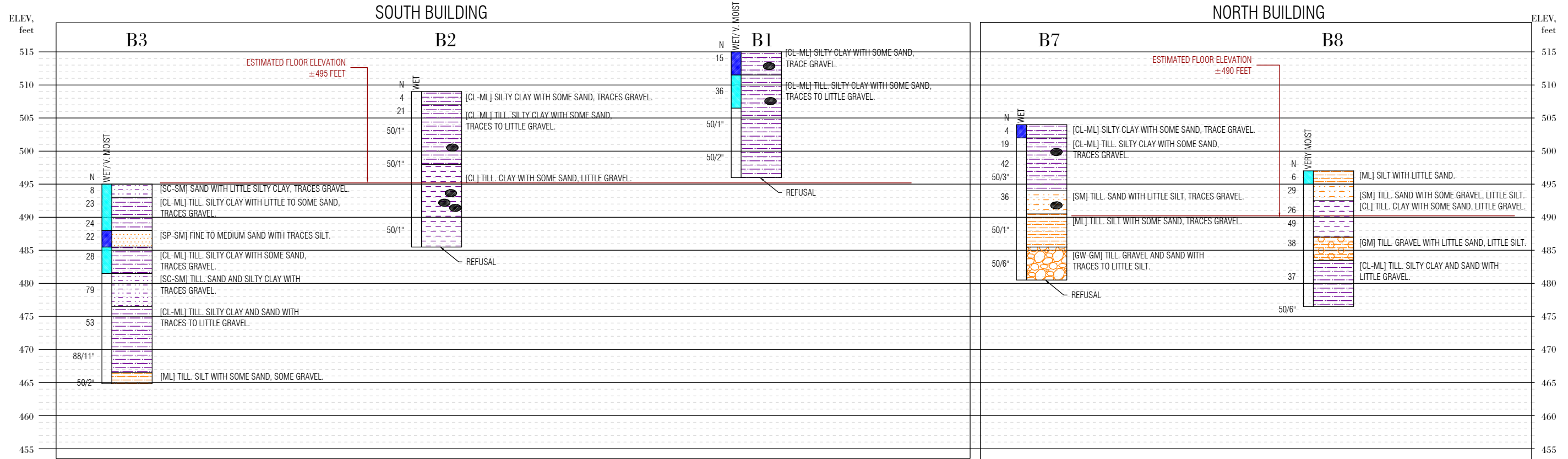

KEVIN L. PATTON, P.E.
36 PATTON ROAD
NEWBURGH, NY 12550
845 275-7732
PATTONGEOTECH.COM

DEWPOINT DOLSONTOWN
TOWN OF WAWAYANDA, N.Y.
SUBSURFACE PROFILE

REV.	DATE	BY
0	5/25/2022	KLP

KEVIN L. PATTON, P.E. 36 PATTON ROAD NEWBURGH, NY 12550 PATTONGEOTECH.COM 845 275-7732	CLIENT:	RDM Group		
	PROJECT:	Dewpoint Dolsontown Rd., Town of Wawayanda, N.Y.		
	DATE:	4/22/2021	Project No.:	21416
	WEATHER:	Clear		

SOIL BORING LOG

DRILLING COMPANY:	General Borings	LOCATION:	South Building, NE corner	BORING NO.	B1
DRILLER AND HELPER:	James Casson, ---	APPROX. ELEV.:	515 feet		
HAMMER TYPE:	Automatic	WATER DEPTH:			
INSPECTOR:	Wyeth Patton				

Feet	SAMPLE			USCS SOIL CLASS	SPT TEST, BLOWS/6"				MOISTURE	DESCRIPTION	NOTES
	#	Type	Rec.		0-6	6-12	12-18	18-24			
0-2	S1	SS	10	CL-ML	1	1	14	50/1	Wet	Silty clay with some sand, trace gravel Yellowish olive-brown PEN = 2.8 ksf	Boulder 2'
5											
5-7	S2	SS	20	CL-ML	8	13	23	50/4	Very Moist	Till - Silty clay with some sand, traces-little gravel Brown with grey mottling PEN = 10 ksf	Boulder 7-8'
10											
10-12	S3	SS	4	CL-ML	50/3				Moist	Same Brown PEN = 16 ksf	
15											
15-17	S4	SS	5	CL-ML	44	50/2			Moist	Same Medium-dark brown PEN = 11 ksf	
20											Refusal 19'
25											
30											
35											
40											
45											

COMMENTS:			
DRILLING METHOD: HSA - Hollow-Stem Auger		MR - Mud-Rotary	MEASUREMENTS IN FEET AND INCHES
SAMPLE/TEST TYPE	SS - SPLIT SPOON	C - CORE	T - UNDISTURBED TUBE
	PEN - HAND PENETROMETER	TOR - TORVANE	V - VANE SHEAR

KEVIN L. PATTON, P.E. 36 PATTON ROAD NEWBURGH, NY 12550 PATTONGEOTECH.COM 845 275-7732	CLIENT:	RDM Group		
	PROJECT:	Dewpoint Dolsontown Rd., Town of Wawayanda, N.Y.		
	DATE:	4/21-22/2021	Project No.:	21416
	WEATHER:	Clear, Rain showers		

SOIL BORING LOG

DRILLING COMPANY:	General Borings	LOCATION:	South Building, north side	BORING NO.	B2
DRILLER AND HELPER:	James Casson, ---		east		
HAMMER TYPE:	Automatic	APPROX. ELEV.:	509 ft		
INSPECTOR:	Wyeth Patton	WATER DEPTH:			

Feet	SAMPLE			USCS SOIL CLASS	SPT TEST, BLOWS/6"				MOISTURE	DESCRIPTION	NOTES
	#	Type	Rec.		0-6	6-12	12-18	18-24			
0-2	S1	SS	22	CL-ML	1	2	2	10	Moist	Silty clay with some sand, traces gravel Brown with grey mottling PEN = 11 ksf	
2-4	S2	SS	10	CL-ML	10	13	18	22	Moist	Till - silty clay with some sand, traces gravel Brown with grey mottling PEN = 15 ksf	
5											
5-7	S3	SS	1	CL-ML	50/1				Moist	Same Brown. Small sample.	8' Refusal, Offset
10											
10-12	S4	SS	1	-	50/1				Moist	Cobble/gravel fragments. Brown. Small sample.	
15											
15-20	Run 1	C	30	Boulder	-				-	Cored 2.5 ft through boulder, continued core 2.5 ft beyond, in soil. Drove split spoon at 20-22 ft. Re-drilled boulder with roller bit.	Refusal 15' Cored through boulder
20		C									
20-22	S5	SS	3	CL	33	50/1			Wet	Till - Clay with some sand, little gravel Olive grey. PEN 12 ksf Attempted to drill with auger, met refusal with steel/weld failure of the first 5-ft auger section.	Refusal 23 1/2'
25											
30											
35											
40											
45											

COMMENTS:			
DRILLING METHOD: HSA - Hollow-Stem Auger		MR - Mud-Rotary	MEASUREMENTS IN FEET AND INCHES
SAMPLE/TEST TYPE	SS - SPLIT SPOON	C - CORE	T - UNDISTURBED TUBE
	PEN - HAND PENETROMETER	TOR - TORVANE	V - VANE SHEAR

KEVIN L. PATTON, P.E. 36 PATTON ROAD NEWBURGH, NY 12550 PATTONGEOTECH.COM 845 275-7732	CLIENT:	RDM Group		
	PROJECT:	Dewpoint Dolsontown Rd., Town of Wawayanda, N.Y.		
	DATE:	4/22/2021	Project No.:	21416
	WEATHER:	Rain Showers		

SOIL BORING LOG

DRILLING COMPANY:	General Borings	LOCATION:	South Building, north side	BORING NO.	B3
DRILLER AND HELPER:	James Casson, ---		west		
HAMMER TYPE:	Automatic	APPROX. ELEV.:	495 ft		
INSPECTOR:	Wyeth Patton	WATER DEPTH:			

Feet	SAMPLE			USCS SOIL CLASS	SPT TEST, BLOWS/6"				MOISTURE	DESCRIPTION	NOTES
	#	Type	Rec.		0-6	6-12	12-18	18-24			
0-2	S1	SS	14	SC-SM	2	3	5	6	Very Moist	Sand with little silty clay, traces gravel Brown, faint mottling	
2-4	S2	SS	20	CL-ML	6	10	13	11	Very Moist	Till - Silty clay with little to some sand, traces gravel. Brown, slightly mottled gray. PEN 12ksf	
5											
5-7	S3	SS	24	CL-ML	10	12	12	16	Very Moist	Till - same Brown with slight grey mottling PEN = 11 ksf	
7-9	S4	SS	20	SP-SM	6	12	10	8	Wet	Sand (FM) with traces silt Brown PEN = 2.8 ksf	
10											
10-12	S5	SS		CL-ML	7	12	16	22	Very Moist	Till - silty clay with some sand, traces gravel Brown with grey mottling PEN = 19 ksf	
15											
15-17	S6	SS		SC-SM	33	35	44	50	Moist	Till - sand and silty clay with traces gravel Brown PEN = 27+ ksf	
20											
20-22	S7	SS		CL-ML	21	26	27	37	Moist	Till - Silty clay and sand (Fmc) with traces to little gravel. Olive grey. PEN = 27+ ksf	
25											
25-27	S8	SS		CL-ML	32	38	50/5		Moist	Till - Silty clay with traces sand, trace gravel Olive grey PEN = 14 ksf	
30											
30-32	S9	SS	2	ML	50/2				Moist	Till - silt with some sand, some gravel Grey. Small sample.	
35											
40											
45											

COMMENTS:

DRILLING METHOD:	HSA - Hollow-Stem Auger	MR - Mud-Rotary	MEASUREMENTS IN FEET AND INCHES		
SAMPLE/TEST TYPE	SS - SPLIT SPOON	C - CORE	T - UNDISTURBED TUBE	AUG - AUGER CUTTINGS	
	PEN - HAND PENETROMETER		TOR - TORVANE	V - VANE SHEAR	

KEVIN L. PATTON, P.E. 36 PATTON ROAD NEWBURGH, NY 12550 PATTONGEOTECH.COM 845 275-7732	CLIENT:	RDM Group		
	PROJECT:	Dewpoint Dolsontown Rd., Town of Wawayanda, N.Y.		
	DATE:	4/22,25/2021	Project No.:	21416
	WEATHER:	Rain Showers		

SOIL BORING LOG

DRILLING COMPANY:	General Borings	LOCATION:	South Building, south side west	BORING NO.	B4
DRILLER AND HELPER:	James Casson, ---	APPROX. ELEV.:	494 feet		
HAMMER TYPE:	Automatic	WATER DEPTH:			
INSPECTOR:	Wyeth Patton				

Feet	SAMPLE			USCS SOIL CLASS	SPT TEST, BLOWS/6"				MOISTURE	DESCRIPTION	NOTES
	#	Type	Rec.		0-6	6-12	12-18	18-24			
0-2	S1	SS	10	ML	2	1	7	14	Very Moist	Silt with some sand, traces gravel, trace roots Yellowish brown PEN = 2 ksf	
2-4	S2	SS	2	ML	17	12	15	21	Moist	Silt with some sand, little gravel Brown. Small sample.	
5											
5-7	S3	SS	22	SM	8	14	15	15	Moist	Till - sand with some silt, little gravel. Strongly mottled brown and grey with orange.	PEN = 11 ksf
7-9	S4	SS	20	CL-ML	18	16	15	20	Wet	Till - silty clay with some sand, little gravel Olive brown PEN = 6 ksf	
10											
10-12	S5	SS	0		21	37	26	36		No Recovery	
15											
15-17	S6	SS	14	SM	15	28	22	25	Very Moist	Till - sand with little to some silt, little gravel Brown, slightly mottled. PEN = 15 ksf Small sample.	
20											
20-22	S7	SS	3	CL-ML	35	50/4			Wet	Till - Silty clay with little sand, little gravel Grey with slight brown mottling. Small sample.	
25											
25-27	S8	SS	0		34	50/4				No Recovery	
30											
30-32	S9	SS	18	ML	20	33	38	50	Very Moist	Till - silt with little sand, traces gravel Grey. PEN = 12 ksf	
35											
40											
45											

COMMENTS:			
DRILLING METHOD: HSA - Hollow-Stem Auger		MR - Mud-Rotary	MEASUREMENTS IN FEET AND INCHES
SAMPLE/TEST TYPE	SS - SPLIT SPOON	C - CORE	T - UNDISTURBED TUBE
	PEN - HAND PENETROMETER	TOR - TORVANE	V - VANE SHEAR

KEVIN L. PATTON, P.E. 36 PATTON ROAD NEWBURGH, NY 12550 PATTONGEOTECH.COM 845 275-7732	CLIENT:	RDM Group		
	PROJECT:	Dewpoint Dolsontown Rd., Town of Wawayanda, N.Y.		
	DATE:	4/25/2022	Project No.:	21416
	WEATHER:	Clear		

SOIL BORING LOG

DRILLING COMPANY:	General Borings	LOCATION:	South Building, east from center	BORING NO.	B5
DRILLER AND HELPER:	James Casson, ---	APPROX. ELEV.:	510 ft		
HAMMER TYPE:	Automatic	WATER DEPTH:			
INSPECTOR:	Wyeth Patton				

Feet	SAMPLE			USCS SOIL CLASS	SPT TEST, BLOWS/6"				MOISTURE	DESCRIPTION	NOTES
	#	Type	Rec.		0-6	6-12	12-18	18-24			
0-2	S1	SS	12	ML	2	2	3	4	Very Moist	Silt with little sand, trace gravel Brown PEN = 5 ksf	
2-4	S2	SS	14	SC-SM	4	8	21	30	Moist	Till. Sand and silty clay with little gravel. Strongly mottled brown and grey with orange.	PEN = 8 ksf
5											
5-7	S3	SS	24	SC-SM	12	12	14	15	Very Moist	Till. Sand with some silty clay, little gravel. Strongly mottled brown and grey with orange.	PEN = 7 ksf
7-9	S4	SS	21	SC-SM	17	17	32	27	Very Moist	Till - same. Olive brown PEN = 15 ksf	
10											
10-12	S5	SS	18	SC-SM	14	19	50/6		Very Moist	Till - sand and silty clay with little gravel Olive brown PEN = 15 ksf	Grinding 12-13'
15											
15-17	S6	SS	5	SM	34	50/2			Moist	Till. Sand with traces to little silt, little gravel Olive brown PEN = 4.5 ksf	Grinding 18'
20											
20-22	S7	SS	8	SM	32	50/5			Moist	Till - sand with some silt, traces gravel Olive brown. PEN = 6 ksf	
25											
25-27	S8	SS	1	CL-ML	50/2				Wet	Till - silty clay with some sand, little gravel Grey. Small sample.	
30											
30-32	S9	SS	9	CL-ML	28	50/5			Moist	Till - silty clay with little sand, traces gravel Grey. PEN = 16 ksf	
35											
40											
45											

COMMENTS:			
DRILLING METHOD:	HSA - Hollow-Stem Auger	MR - Mud-Rotary	MEASUREMENTS IN FEET AND INCHES
SAMPLE/TEST TYPE	SS - SPLIT SPOON	C - CORE	T - UNDISTURBED TUBE
	PEN - HAND PENETROMETER	TOR - TORVANE	V - VANE SHEAR

KEVIN L. PATTON, P.E. 36 PATTON ROAD NEWBURGH, NY 12550 PATTONGEOTECH.COM 845 275-7732	CLIENT:	RDM Group		
	PROJECT:	Dewpoint Dolsontown Rd., Town of Wawayanda, N.Y.		
	DATE:	4/25-26/2022	Project No.:	21416
	WEATHER:	Rain Showers		

SOIL BORING LOG

DRILLING COMPANY:	General Borings	LOCATION:	South Building, SE corner	BORING NO.	B6
DRILLER AND HELPER:	James Casson, ---	APPROX. ELEV.:	486 ft		
HAMMER TYPE:	Automatic	WATER DEPTH:	7.38 ft on 5-25-22 (29 days)		
INSPECTOR:	Wyeth Patton				

Feet	SAMPLE			USCS SOIL CLASS	SPT TEST, BLOWS/6"				MOISTURE	DESCRIPTION	NOTES
	#	Type	Rec.		0-6	6-12	12-18	18-24			
0-2	S1	SS	8	ML	2	3	2	2	Very Moist	Silt with traces to little sand, traces gravel, trace small roots. Brown.	
2-4	S2	SS	20	CL-ML	3	11	11	9	Moist	Till - silty clay with some sand, trace gravel Brown PEN = 9 ksf	Standpipe piezometer installed to 11.9 ft below
5											
5-7	S3	SS	20	SM	7	15	28	29	Moist	Till - sand with little silt, little gravel Olive brown PEN = 10 ksf	grade, well screen on bottom 3 feet.
7-9	S4	SS	20	SC-SM	31	22	21	30	Moist	Till - sand with some silty clay, traces gravel Olive brown PEN = 16 ksf	
10											
10-12	S5	SS	18	SM	10	24	24	48	Moist	Till - Sand and silt with traces gravel Grey. PEN = 19 ksf	
15											
15-17	S6	SS	10	ML	48	50/4			Moist	Till - Silt with some sand, trace gravel Grey PEN 9 ksf	
20											
20-22	S7	SS	9	ML	21	41	45	50/3	Moist	Till - Silt with traces sand, trace gravel Grey PEN 12 ksf	
25											
30											
35											
40											
45											

COMMENTS:			
DRILLING METHOD:	HSA - Hollow-Stem Auger	MR - Mud-Rotary	MEASUREMENTS IN FEET AND INCHES
SAMPLE/TEST TYPE	SS - SPLIT SPOON	C - CORE	T - UNDISTURBED TUBE
	PEN - HAND PENETROMETER	TOR - TORVANE	V - VANE SHEAR

KEVIN L. PATTON, P.E. 36 PATTON ROAD NEWBURGH, NY 12550 PATTONGEOTECH.COM 845 275-7732	CLIENT:	RDM Group		
	PROJECT:	Dewpoint Dolsontown Rd., Town of Wawayanda, N.Y.		
	DATE:	4/26/2022	Project No.:	21416
	WEATHER:	Rain Showers		

SOIL BORING LOG

DRILLING COMPANY:	General Borings	LOCATION:	North Building, SW corner	BORING NO.	B7
DRILLER AND HELPER:	James Casson, ---	APPROX. ELEV.:	504 ft		
HAMMER TYPE:	Automatic	WATER DEPTH:			
INSPECTOR:	Wyeth Patton				

Feet	SAMPLE			USCS SOIL CLASS	SPT TEST, BLOWS/6"				MOISTURE	DESCRIPTION	NOTES
	#	Type	Rec.		0-6	6-12	12-18	18-24			
0-2	S1	SS	20	CL-ML	2	1	3	9	Wet	Silty clay with some sand, trace gravel	
2-4	S2	SS	20	CL-ML	8	9	10	12	Moist	Olive brown PEN = 1.5 ksf Till - silty clay with some sand, traces gravel	
5										Strongly mottled brown and grey with orange, Grinding 4' - cobble	PEN = 13 ksf
5-7	S3	SS	8	CL-ML	10	18	24	23	Moist	Till - same Brown	
7-9	S4	SS	4	CL-ML	50/3				Moist	Till - same Brown PEN = 9 ksf	
10											
10-12	S5	SS	20	SM	29	18	18	19	Moist	Till - sand with little silt, traces gravel Olive brown	Grinding 12'
15											
15-17	S6	SS	4	ML	41	50/1			Moist	Till - silt with some sand, traces gravel Olive brown PEN = 6 ksf	
20											
20-22	S7	SS	4	GW-GM	50/6				Moist	Till - Gravel and sand with traces to little silt. Brown PEN = 12 ksf	Refusal 23.5 ft
25											
30											
35											
40											
45											

COMMENTS:			
DRILLING METHOD: HSA - Hollow-Stem Auger		MR - Mud-Rotary	MEASUREMENTS IN FEET AND INCHES
SAMPLE/TEST TYPE	SS - SPLIT SPOON	C - CORE	T - UNDISTURBED TUBE
	PEN - HAND PENETROMETER	TOR - TORVANE	V - VANE SHEAR

KEVIN L. PATTON, P.E. 36 PATTON ROAD NEWBURGH, NY 12550 PATTONGEOTECH.COM 845 275-7732	CLIENT:	RDM Group		
	PROJECT:	Dewpoint Dolsontown Rd., Town of Wawayanda, N.Y.		
	DATE:	4/26/2022	Project No.:	21416
	WEATHER:	Rain Showers		

SOIL BORING LOG

DRILLING COMPANY:	General Borings	LOCATION:	North Building, NE corner	BORING NO.	B8
DRILLER AND HELPER:	James Casson, ---	APPROX. ELEV.:	497 ft		
HAMMER TYPE:	Automatic	WATER DEPTH:			
INSPECTOR:	Wyeth Patton				

Feet	SAMPLE			USCS SOIL CLASS	SPT TEST, BLOWS/6"				MOISTURE	DESCRIPTION	NOTES
	#	Type	Rec.		0-6	6-12	12-18	18-24			
0-2	S1	SS	3	ML	2	3	3	3	Very Moist	Silt with little sand, half-inch diameter root.	
2-4	S2	SS	12	SM	6	12	17	22	Moist	Till - sand with some gravel, little silt Brown, slightly mottled.	
5											
5-7	S3	SS	22	CL	10	11	15	13	Moist	Till - Clay with some sand, little gravel Olive brown PEN = 12 ksf	
7-9	S4	SS	6	CL	16	28	21	30	Moist	Till - Same Olive brown PEN = 20 ksf	Note: Lab sample had 49% passing the #200 sieve,
10											classified as 'SC.'
10-12	S5	SS	1	GM	15	17	21	18	Moist	Till. Gravel with little sand, little silt Olive brown. Small sample.	
15											
15-17	S6	SS	12	CL-ML	19	19	18	20	Moist	Till. Silty clay and sand with little gravel Olive brown. PEN 18 ksf	
20											
20-22	S7	SS	0		50/6					No Recovery	
25											
30											
35											
40											
45											

COMMENTS:			
DRILLING METHOD: HSA - Hollow-Stem Auger		MR - Mud-Rotary	MEASUREMENTS IN FEET AND INCHES
SAMPLE/TEST TYPE	SS - SPLIT SPOON	C - CORE	T - UNDISTURBED TUBE
	PEN - HAND PENETROMETER	TOR - TORVANE	V - VANE SHEAR

KEVIN L. PATTON, P.E.
36 PATTON ROAD
NEWBURGH, NY 12550
845 275-7732 PATTONGEOTECH.COM

CLIENT:	RDM Group		
PROJECT:	Dewpoint Dolsontown		
PROJECT No.:	21416	SAMPLE LOT No.:	220426-1
DATE SAMPLED:	4/21,22,25/2022	DATE TESTED:	5/18/2022
SAMPLED BY:	Wyeth Patton	TESTED BY:	Wyeth Patton

MOISTURE CONTENT OF SOIL
TEST METHOD: ASTM D2216

SAMPLE NO.	DEPTH, FT.	% MOISTURE
B1 S2	6	12.5
B1 S3	11	10.9
B2 S2	3	11.4
B2 S5	21	9.3
B3 S2	3	12.2
B3 S3	6	11.8
B3 S4	8	14.2
B3 S6	16	9.0
B3 S7	21	8.3
B3 S8	26	11.0
B4 S3	6	11.6
B4 S4	8	11.9
B4 S6	16	9.9
B4 S7	21	13.1
B4 S9	31	11.8
B5 S2	3	8.0
B5 S3	6	11.2
B5 S4	8	11.2
B5 S5	11	9.8
B5 S6	16	7.8
B5 S7	21	8.8
B6 S2	3	11.9
B6 S3	6	8.8
B6 S4	8	10.5
B6 S5	11	11.6
B6 S6	16	7.6
B6 S7	21	9.6

Moisture content is expressed as a percent of the dry mass of the soil.

Reviewed by: *Kevin Patton*

KEVIN L. PATTON, P.E.
36 PATTON ROAD
NEWBURGH, NY 12550
845 275-7732 PATTONGEOTECH.COM

CLIENT:	RDM Group		
PROJECT:	Dewpoint Dolsontown		
PROJECT No.:	21416	SAMPLE LOT No.:	220426-1
DATE SAMPLED:	4/26/2022	DATE TESTED:	5/18/2022
SAMPLED BY:	Wyeth Patton	TESTED BY:	Wyeth Patton

MOISTURE CONTENT OF SOIL
TEST METHOD: ASTM D2216

	SAMPLE NO.	DEPTH, FT.	% MOISTURE
r	B7 S2	3	11.8
	B7 S3	6	11.8
	B7 S5	11	13.1
	B7 S6	16	9.3
	B7 S7	21	3.7
	B8 S2	3	8.9
	B8 S3	6	10.3
	B8 S6	16	9.2

Moisture content is expressed as a percent of the dry mass of the soil.

Reviewed by: *Kevin Patton*

Form NMC

KEVIN L. PATTON, P.E.
36 PATTON ROAD
NEWBURGH, NY 12550
845 275-7732 PATTONGEOTECH.COM

CLIENT:	RDM Group		
PROJECT:	Dewpoint Dolsontown		
PROJECT No.:	21416	SAMPLE LOT No.:	220426-1
DATE SAMPLED:	4/25/2022	DATE TESTED:	5/18/2022
SAMPLED BY:	Wyeth Patton	TESTED BY:	Wyeth Patton

SIEVE-AND-HYDROMETER ANALYSIS TEST REPORT
TEST METHOD(S): ASTM D422, AASHTO T88

Sample Location	B5-S9
Depth	31 feet

Sieve Size		Percent Retained	Percent Passing	Specification
inches	mm			
3/4"	19.0	0	100	
3/8"	9.5	5	95	
#4	4.75	5	90	
#10	2.00	6	84	
#18	1.00	2	82	
#40	0.425	4	78	
#100	0.150	6	72	
#200	0.075	4	68	
Hydrometer Analysis	0.050	3	65	
	0.020	10	55	
	0.010	15	40	
	0.005	14	26	
	0.002	11	15	
	0.001	3	12	

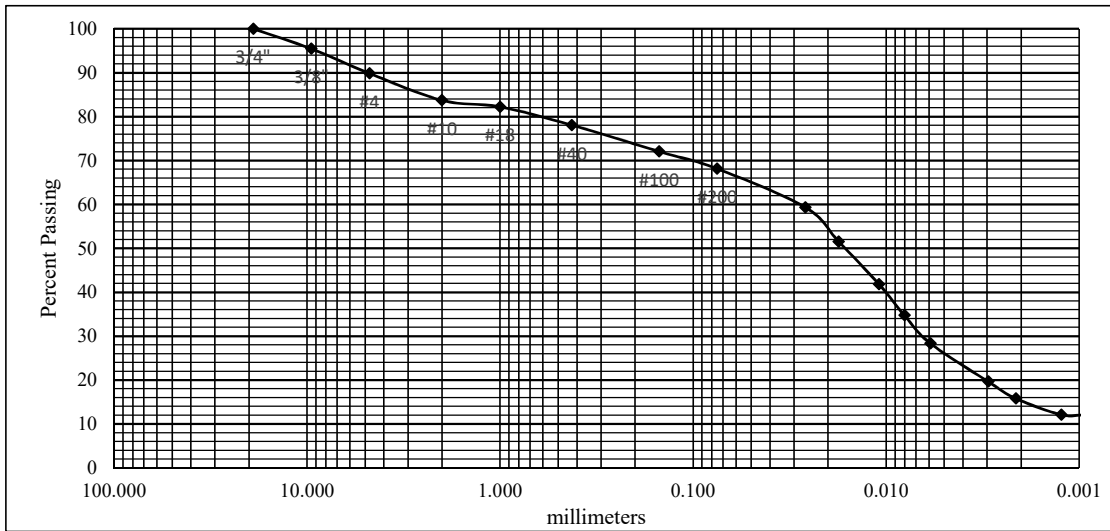

USDA Particle Size Classification:	USDA Textural Class: Gravelly Silt Loam
Gravel, 3" to 2.00mm: 16	USCS Classification (ASTM D2487/D2488): CL-ML, Sandy Silty Clay
Sand, 2.00 to 0.050mm: 19	
Silt, 0.050 to 0.002mm: 50	Atterberg Limits were determined by: Test
Clay, <0.002mm: 15	
Total: 100	

Reviewed by: *Kevin Patton*

Form HYD

KEVIN L. PATTON, P.E.
36 PATTON ROAD
NEWBURGH, NY 12550
845 275-7732 PATTONGEOTECH.COM

CLIENT:	RDM Group		
PROJECT:	Dewpoint Dolsontown		
PROJECT No.:	21416	SAMPLE LOT No.:	220426-1
DATE SAMPLED:	4/26/2022	DATE TESTED:	1/0/1900
SAMPLED BY:	Wyeth Patton	TESTED BY:	0

SIEVE-AND-HYDROMETER ANALYSIS TEST REPORT
TEST METHOD(S): ASTM D422, AASHTO T88

Sample Location	B8-S4
Depth	8 feet

Sieve Size		Percent Retained	Percent Passing	Specification
inches	mm			
3/4"	19.0	0	100	
3/8"	9.5	7	93	
#4	4.75	12	81	
#10	2.00	8	73	
#18	1.00	3	70	
#40	0.425	6	64	
#100	0.150	9	55	
#200	0.075	6	49	
Hydrometer Analysis	0.050	3	46	
	0.020	8	38	
	0.010	6	32	
	0.005	7	25	
	0.002	8	17	
	0.001	3	14	

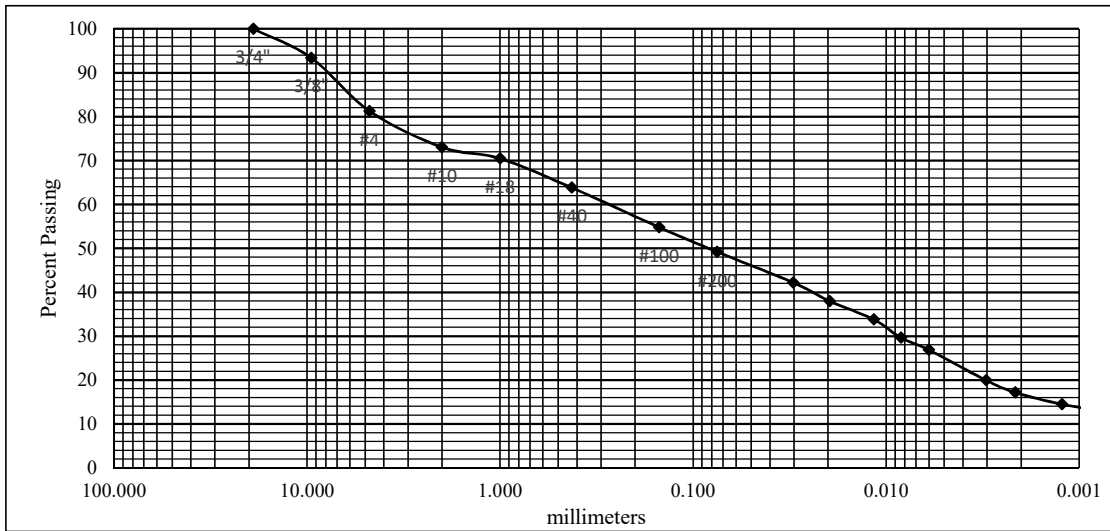

USDA Particle Size Classification:	USDA Textural Class: Gravelly Loam
Gravel, 3" to 2.00mm: 27	USCS Classification (ASTM D2487/D2488): SC, Clayey Sand with Gravel
Sand, 2.00 to 0.050mm: 27	
Silt, 0.050 to 0.002mm: 29	Atterberg Limits were determined by: Test
Clay, <0.002mm: 17	
Total: 100	

Reviewed by: Kevin Patton

Form HYD

KEVIN L. PATTON, P.E.
36 PATTON ROAD
NEWBURGH, NY 12550
845 275-7732 PATTONGEOTECH.COM

CLIENT:	RDM Group		
PROJECT:	Dewpoint Dolson town		
PROJECT No.:	21416	SAMPLE LOT No.:	220426-1
DATE SAMPLED:	4/25/2022	DATE TESTED:	5/18/2022
SAMPLED BY:	Wyeth Patton	TESTED BY:	Wyeth Patton

ATTERBERG LIMITS TEST
TEST METHODS: ASTM D4318/ AASHTO T89, T90

Sample Location	B5-S9
Depth	31 feet
Percent Passing #40	78
Liquid Limit (LL)	20
Plastic Limit (PL)	15
Plasticity Index (PI)	5
USCS Class of -#40	CL-ML, Silty Clay

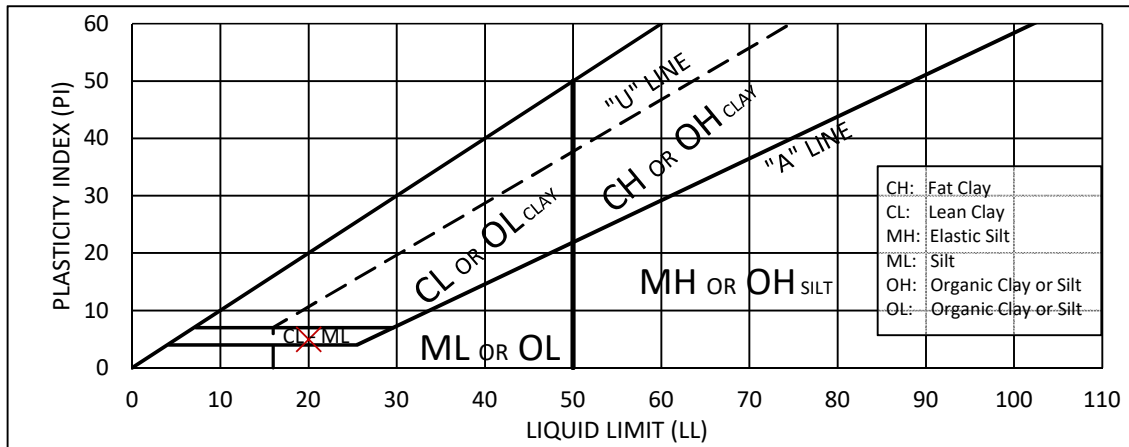

LL, PL and PI values are percent moisture of the soil by dry mass.

Test is performed on the 'matrix' fraction of the soil, finer than the #40 (0.425mm) sieve.

The Liquid Limit is the moisture content at which the matrix fraction of the soil changes from a stiff to a flowing consistency. The plastic limit is the moisture content at which it changes from cohesive to crumbly. The Plasticity Index is the Liquid Limit minus the Plastic Limit.

Reviewed by: *Kevin Patton*

KEVIN L. PATTON, P.E.
36 PATTON ROAD
NEWBURGH, NY 12550
845 275-7732 PATTONGEOTECH.COM

CLIENT:	RDM Group		
PROJECT:	Dewpoint Dolsonstown		
PROJECT No.:	21416	SAMPLE LOT No.:	220426-1
DATE SAMPLED:	4/26/2022	DATE TESTED:	5/18/2022
SAMPLED BY:	Wyeth Patton	TESTED BY:	Wyeth Patton

ATTERBERG LIMITS TEST
TEST METHODS: ASTM D4318/ AASHTO T89, T90

Sample Location	B8-S4
Depth	8 feet
Percent Passing #40	64
Liquid Limit (LL)	23
Plastic Limit (PL)	15
Plasticity Index (PI)	8
USCS Class of -#40	CL, Lean Clay

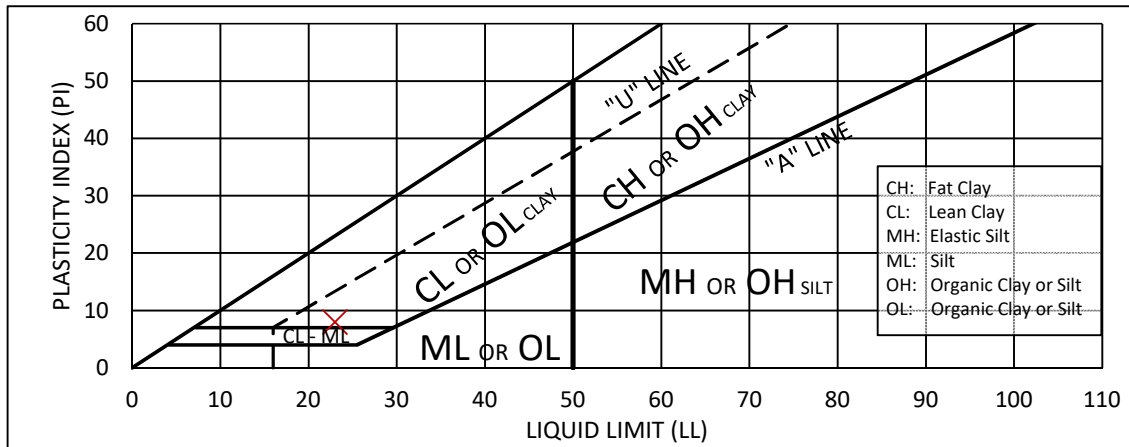

LL, PL and PI values are percent moisture of the soil by dry mass.

Test is performed on the 'matrix' fraction of the soil, finer than the #40 (0.425mm) sieve.

The Liquid Limit is the moisture content at which the matrix fraction of the soil changes from a stiff to a flowing consistency. The plastic limit is the moisture content at which it changes from cohesive to crumbly. The Plasticity Index is the Liquid Limit minus the Plastic Limit.

Reviewed by: *Kevin Patton*

KEVIN L. PATTON, P.E.
36 PATTON ROAD
NEWBURGH, NY 12550
845 275-7732 kevin@pattongeotech.com

CLIENT:	RDM Group		
PROJECT:	Dewpoint Dolsontown		
PROJECT No.:	21416	SAMPLE LOT No.:	220426-1
DATE SAMPLED:	4/22/2022	DATE TESTED:	5/10/2022
SAMPLED BY:	Wyeth Patton	TESTED BY:	Kevin Patton

DENSITY AND MOISTURE CONTENT OF SOIL

Sample	Depth, ft	Moist Density, pcf	Dry Density, pcf	Percent Moisture
B3-S5	11	140	123	13.8

Moisture content was determined per ASTM D2216 and is expressed as a percent of the dry mass of the soil.
Density values were determined from the wet and dry masses of the specimen, with volume calculated from measured dimensions.

Reviewed by: *Kevin Patton*

Soil Map—Orange County, New York

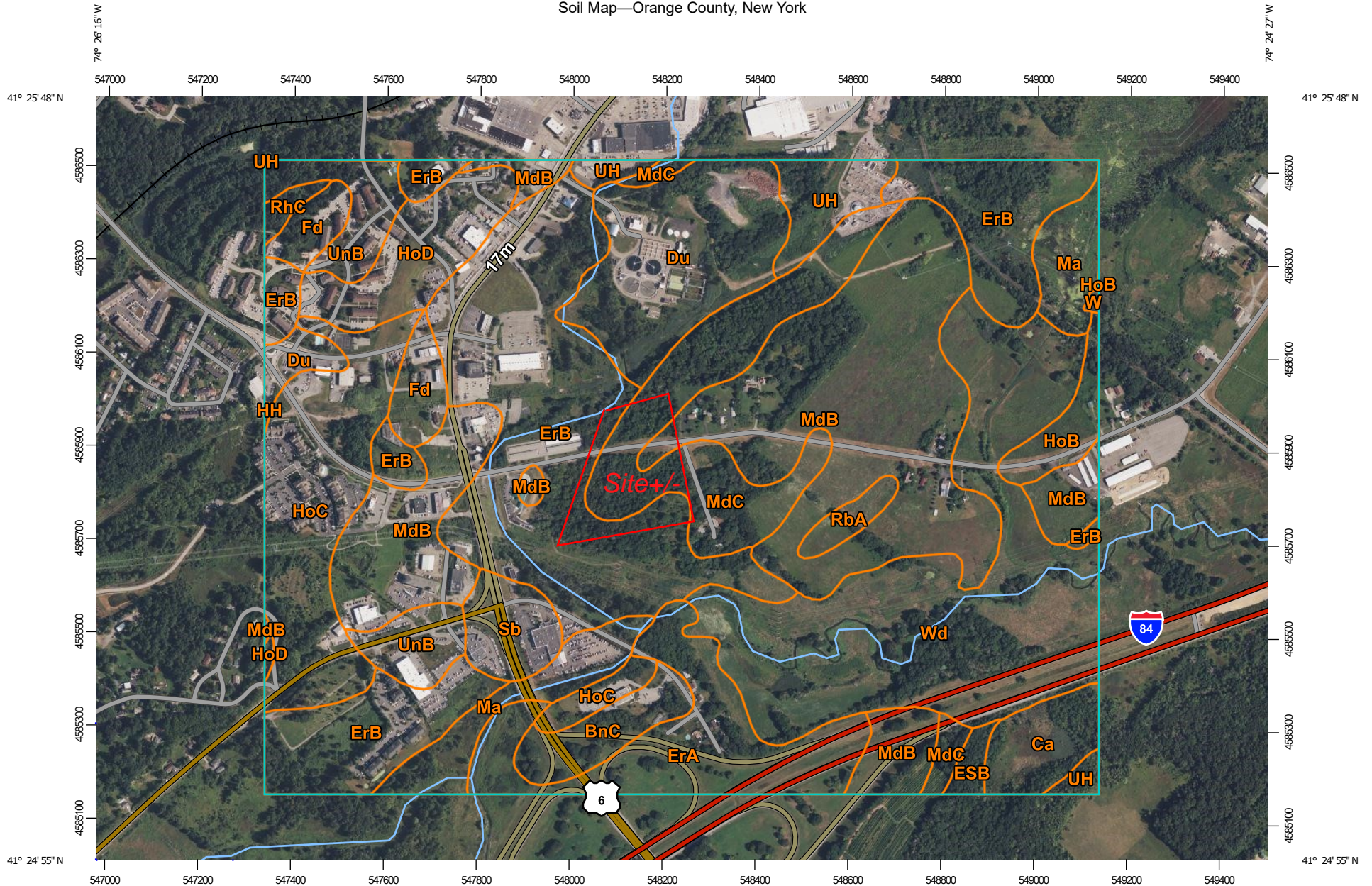

Map Scale: 1:11,500 if printed on A landscape (11" x 8.5") sheet.

0 150 300 600 900 Meters
0 500 1000 2000 3000 Feet

Map projection: Web Mercator Corner coordinates: WGS84 Edge tics: UTM Zone 18N WGS84

Soil Map—Orange County, New York

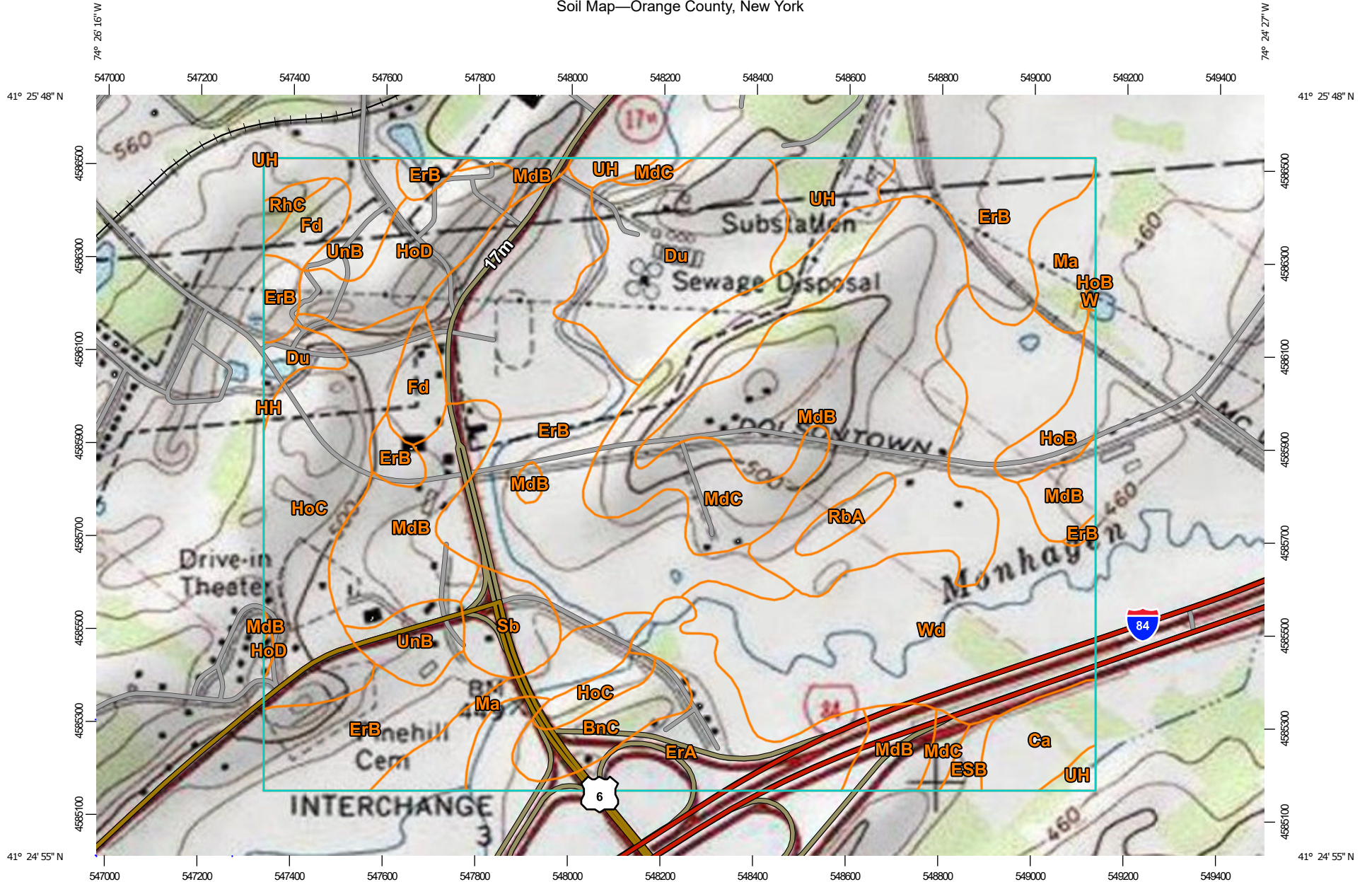

Map Scale: 1:11,500 if printed on A landscape (11" x 8.5") sheet.

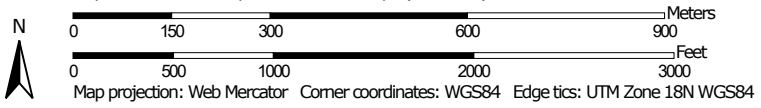

MAP LEGEND

Area of Interest (AOI)

 Area of Interest (AOI)



















Soils







 Soil Map Unit Polygons

 Soil Map Unit Lines





 Soil Map Unit Points

Special Point Features

-  Blowout
-  Borrow Pit
-  Clay Spot
-  Closed Depression
-  Gravel Pit
-  Gravelly Spot
-  Landfill
-  Lava Flow
-  Marsh or swamp
-  Mine or Quarry
-  Miscellaneous Water
-  Perennial Water
-  Rock Outcrop
-  Saline Spot
-  Sandy Spot
-  Severely Eroded Spot
-  Sinkhole
-  Slide or Slip
-  Sodic Spot

-  Spoil Area
-  Stony Spot
-  Very Stony Spot
-  Wet Spot
-  Other
-  Special Line Features

Transportation

-  Rails
-  Interstate Highways
-  US Routes
-  Major Roads
-  Local Roads

Background

-  Topographic Map

MAP INFORMATION

The soil surveys that comprise your AOI were mapped at 1:15,800.

Please rely on the bar scale on each map sheet for map measurements.

Source of Map: Natural Resources Conservation Service
 Web Soil Survey URL:
 Coordinate System: Web Mercator (EPSG:3857)

Maps from the Web Soil Survey are based on the Web Mercator projection, which preserves direction and shape but distorts distance and area. A projection that preserves area, such as the Albers equal-area conic projection, should be used if more accurate calculations of distance or area are required.

This product is generated from the USDA-NRCS certified data as of the version date(s) listed below.

Soil Survey Area: Orange County, New York
 Survey Area Data: Version 22, Aug 29, 2021

Soil map units are labeled (as space allows) for map scales 1:50,000 or larger.

Map Unit Legend

Map Unit Symbol	Map Unit Name	Acres in AOI	Percent of AOI
BnC	Bath-Nassau channery silt loams, 8 to 15 percent slopes	10.1	1.7%
Ca	Canandaigua silt loam	10.3	1.7%
Du	Dumps	39.4	6.5%
ErA	Erie gravelly silt loam, 0 to 3 percent slopes	32.9	5.4%
ErB	Erie gravelly silt loam, 3 to 8 percent slopes	126.1	20.8%
ESB	Erie extremely stony soils, gently sloping	2.3	0.4%
Fd	Fredon loam	10.7	1.8%
HH	Histic Humaquepts, ponded	0.2	0.0%
HoB	Hoosic gravelly sandy loam, 3 to 8 percent slopes	6.7	1.1%
HoC	Hoosic gravelly sandy loam, 8 to 15 percent slopes	43.7	7.2%
HoD	Hoosic gravelly sandy loam, 15 to 25 percent slopes	18.6	3.1%
Ma	Madalin silt loam	21.0	3.5%
MdB	Mardin gravelly silt loam, 3 to 8 percent slopes	114.3	18.8%
MdC	Mardin gravelly silt loam, 8 to 15 percent slopes	39.5	6.5%
RbA	Rhinebeck silt loam, 0 to 3 percent slopes	3.5	0.6%
RhC	Riverhead sandy loam, 8 to 15 percent slopes	1.8	0.3%
Sb	Scarboro mucky fine sandy loam, 0 to 3 percent slopes	9.5	1.6%
UH	Udorthents, smoothed	12.5	2.1%
UnB	Unadilla silt loam, 0 to 8 percent slopes	17.2	2.8%
W	Water	0.3	0.0%
Wd	Wayland soils complex, non-calcareous substratum, 0 to 3 percent slopes, frequently flooded	86.2	14.2%
Totals for Area of Interest		606.8	100.0%

Engineering Properties

This table gives the engineering classifications and the range of engineering properties for the layers of each soil in the survey area.

Hydrologic soil group is a group of soils having similar runoff potential under similar storm and cover conditions. The criteria for determining Hydrologic soil group is found in the National Engineering Handbook, Chapter 7 issued May 2007(<http://directives.sc.egov.usda.gov/OpenNonWebContent.aspx?content=17757.wba>). Listing HSGs by soil map unit component and not by soil series is a new concept for the engineers. Past engineering references contained lists of HSGs by soil series. Soil series are continually being defined and redefined, and the list of soil series names changes so frequently as to make the task of maintaining a single national list virtually impossible. Therefore, the criteria is now used to calculate the HSG using the component soil properties and no such national series lists will be maintained. All such references are obsolete and their use should be discontinued. Soil properties that influence runoff potential are those that influence the minimum rate of infiltration for a bare soil after prolonged wetting and when not frozen. These properties are depth to a seasonal high water table, saturated hydraulic conductivity after prolonged wetting, and depth to a layer with a very slow water transmission rate. Changes in soil properties caused by land management or climate changes also cause the hydrologic soil group to change. The influence of ground cover is treated independently. There are four hydrologic soil groups, A, B, C, and D, and three dual groups, A/D, B/D, and C/D. In the dual groups, the first letter is for drained areas and the second letter is for undrained areas.

The four hydrologic soil groups are described in the following paragraphs:

Group A. Soils having a high infiltration rate (low runoff potential) when thoroughly wet. These consist mainly of deep, well drained to excessively drained sands or gravelly sands. These soils have a high rate of water transmission.

Group B. Soils having a moderate infiltration rate when thoroughly wet. These consist chiefly of moderately deep or deep, moderately well drained or well drained soils that have moderately fine texture to moderately coarse texture. These soils have a moderate rate of water transmission.

Group C. Soils having a slow infiltration rate when thoroughly wet. These consist chiefly of soils having a layer that impedes the downward movement of water or soils of moderately fine texture or fine texture. These soils have a slow rate of water transmission.

Group D. Soils having a very slow infiltration rate (high runoff potential) when thoroughly wet. These consist chiefly of clays that have a high shrink-swell potential, soils that have a high water table, soils that have a claypan or clay layer at or near the surface, and soils that are shallow over nearly impervious material. These soils have a very slow rate of water transmission.

Depth to the upper and lower boundaries of each layer is indicated.

Texture is given in the standard terms used by the U.S. Department of Agriculture. These terms are defined according to percentages of sand, silt, and clay in the fraction of the soil that is less than 2 millimeters in diameter. "Loam," for example, is soil that is 7 to 27 percent clay, 28 to 50 percent silt, and less than 52 percent sand. If the content of particles coarser than sand is 15 percent or more, an appropriate modifier is added, for example, "gravelly."

Classification of the soils is determined according to the Unified soil classification system (ASTM, 2005) and the system adopted by the American Association of State Highway and Transportation Officials (AASHTO, 2004).

The Unified system classifies soils according to properties that affect their use as construction material. Soils are classified according to particle-size distribution of the fraction less than 3 inches in diameter and according to plasticity index, liquid limit, and organic matter content. Sandy and gravelly soils are identified as GW, GP, GM, GC, SW, SP, SM, and SC; silty and clayey soils as ML, CL, OL, MH, CH, and OH; and highly organic soils as PT. Soils exhibiting engineering properties of two groups can have a dual classification, for example, CL-ML.

The AASHTO system classifies soils according to those properties that affect roadway construction and maintenance. In this system, the fraction of a mineral soil that is less than 3 inches in diameter is classified in one of seven groups from A-1 through A-7 on the basis of particle-size distribution, liquid limit, and plasticity index. Soils in group A-1 are coarse grained and low in content of fines (silt and clay). At the other extreme, soils in group A-7 are fine grained. Highly organic soils are classified in group A-8 on the basis of visual inspection.

If laboratory data are available, the A-1, A-2, and A-7 groups are further classified as A-1-a, A-1-b, A-2-4, A-2-5, A-2-6, A-2-7, A-7-5, or A-7-6. As an additional refinement, the suitability of a soil as subgrade material can be indicated by a group index number. Group index numbers range from 0 for the best subgrade material to 20 or higher for the poorest.

Percentage of rock fragments larger than 10 inches in diameter and 3 to 10 inches in diameter are indicated as a percentage of the total soil on a dry-weight basis. The percentages are estimates determined mainly by converting volume percentage in the field to weight percentage. Three values are provided to identify the expected Low (L), Representative Value (R), and High (H).

Percentage (of soil particles) passing designated sieves is the percentage of the soil fraction less than 3 inches in diameter based on an oven-dry weight. The sieves, numbers 4, 10, 40, and 200 (USA Standard Series), have openings of 4.76, 2.00, 0.420, and 0.074 millimeters, respectively. Estimates are based on laboratory tests of soils sampled in the survey area and in nearby areas and on estimates made in the field. Three values are provided to identify the expected Low (L), Representative Value (R), and High (H).

Liquid limit and plasticity index (Atterberg limits) indicate the plasticity characteristics of a soil. The estimates are based on test data from the survey area or from nearby areas and on field examination. Three values are provided to identify the expected Low (L), Representative Value (R), and High (H).

References:

American Association of State Highway and Transportation Officials (AASHTO). 2004. Standard specifications for transportation materials and methods of sampling and testing. 24th edition.

American Society for Testing and Materials (ASTM). 2005. Standard classification of soils for engineering purposes. ASTM Standard D2487-00.

Report—Engineering Properties

Absence of an entry indicates that the data were not estimated. The asterisk "*" denotes the representative texture; other possible textures follow the dash. The criteria for determining the hydrologic soil group for individual soil components is found in the National Engineering Handbook, Chapter 7 issued May 2007(<http://directives.sc.egov.usda.gov/OpenNonWebContent.aspx?content=17757.wba>). Three values are provided to identify the expected Low (L), Representative Value (R), and High (H).

Engineering Properties—Orange County, New York														
Map unit symbol and soil name	Pct. of map unit	Hydrologic group	Depth	USDA texture	Classification		Pct Fragments		Percentage passing sieve number—				Liquid limit	Plasticity index
					Unified	AASHTO	>10 inches	3-10 inches	4	10	40	200		
			<i>In</i>				<i>L-R-H</i>	<i>L-R-H</i>	<i>L-R-H</i>	<i>L-R-H</i>	<i>L-R-H</i>	<i>L-R-H</i>	<i>L-R-H</i>	
ErB—Erie gravelly silt loam, 3 to 8 percent slopes														
Erie	80	D	0-9	Gravelly silt loam	GM, ML, SM	A-2, A-4	0- 0- 0	0- 2- 5	65-85-90	50-75-75	35-65-70	20-60-65	30-35-40	5-8 -10
			9-18	Channery fine sandy loam, channery silt loam, channery loam	CL-ML, CL, GC, SC	A-1, A-2, A-4	0- 0- 2	0- 2- 10	65-85-90	50-75-75	35-65-70	20-55-65	15-20-25	5-8 -10
			18-54	Channery silt loam, channery silty clay loam, very channery loam	CL, GC, SC	A-2, A-4, A-6	0- 2- 5	0- 2- 20	50-80-85	35-70-70	25-65-70	20-55-65	25-30-35	10-13-15
			54-70	Channery silt loam, channery silty clay loam, very channery loam	CL, GC, SC	A-2, A-6	0- 2- 5	0- 2- 25	50-80-85	35-70-70	25-65-70	20-55-65	25-30-35	10-13-15

Engineering Properties--Orange County, New York														
Map unit symbol and soil name	Pct. of map unit	Hydrologic group	Depth	USDA texture	Classification		Pct Fragments		Percentage passing sieve number--				Liquid limit	Plasticity index
					Unified	AASHTO	>10 inches	3-10 inches	4	10	40	200		
			<i>In</i>				<i>L-R-H</i>	<i>L-R-H</i>	<i>L-R-H</i>	<i>L-R-H</i>	<i>L-R-H</i>	<i>L-R-H</i>	<i>L-R-H</i>	<i>L-R-H</i>
MdC--Mardin gravelly silt loam, 8 to 15 percent slopes														
Mardin	85	D	0-8	Channery silt loam, silt loam, gravelly silt loam, channery loam	GC-GM, MH, ML	A-2-4, A-4, A-7-5	0- 0- 3	0- 4- 19	43-70-90	41-68-90	33-62-89	28-54-82	27-35-56	6-9 -16
			8-15	Channery silt loam, gravelly loam, gravelly silt loam, channery loam, silt loam, flaggy silt loam	GC-GM, CL	A-2-4, A-4, A-6	0- 0- 3	0- 4- 18	44-71-91	41-69-90	34-61-88	28-54-81	22-27-38	6-9 -15
			15-20	Gravelly silt loam, loam, gravelly loam, channery silt loam, channery loam, silt loam	CL-ML, CL, GM	A-2-4, A-4, A-6	0- 0- 3	0- 4- 18	46-72-91	43-71-91	34-63-88	26-51-77	17-23-32	2-7 -12
			20-72	Very flaggy loam, very channery loam, channery silt loam, gravelly loam, very channery silt loam, channery loam, gravelly silt loam, very flaggy silt loam	CL, GM	A-1-b, A-6	0- 3- 17	3- 6- 40	33-74-82	30-73-81	23-63-80	18-55-73	16-28-35	2-12-17

Data Source Information

Soil Survey Area: Orange County, New York
 Survey Area Data: Version 22, Aug 29, 2021

Appendix 16 | Hydro International First Defense Swirl Chamber Information

First Defense® High Capacity

A Simple Solution for your Trickiest Sites

Product Profile

The First Defense® High Capacity is an enhanced vortex separator that combines an effective stormwater treatment chamber with an integral peak flow bypass. It efficiently removes sediment total suspended solids (TSS), trash and hydrocarbons from stormwater runoff without washing out previously captured pollutants. The First Defense® High Capacity is available in several model configurations to accommodate a wide range of pipe sizes, peak flows and depth constraints (**Table 1**, next page).

Applications

- Stormwater treatment at the point of entry into the drainage line
- Sites constrained by space, topography or drainage profiles with limited slope and depth of cover
- Retrofit installations where stormwater treatment is placed on or tied into an existing storm drain line
- Pretreatment for filters, infiltration and storage

Advantages

- Inlet options include surface grate or multiple inlet pipes
- Integral high capacity bypass conveys large peak flows without the need for “offline” arrangements using separate junction manholes
- Proven to prevent pollutant washout at up to 450% of its treatment flow
- Long flow path through the device ensures a long residence time within the treatment chamber, enhancing pollutant settling
- Delivered to site pre-assembled and ready for installation

How it Works

The First Defense® High Capacity has internal components designed to remove and retain gross debris, total suspended solids (TSS) and hydrocarbons (**Fig.1**).

Contaminated stormwater runoff enters the inlet chute from a surface grate and/or inlet pipe. The inlet chute introduces flow into the chamber tangentially to create a low energy vortex flow regime (**magenta arrow**) that directs sediment into the sump while oils, floating trash and debris rise to the surface.

Treated stormwater exits through a submerged outlet chute located opposite to the direction of the rotating flow (**blue arrow**). Enhanced vortex separation is provided by forcing the rotating flow within the vessel to follow the longest path possible rather than directly from inlet to outlet.

Higher flows bypass the treatment chamber to prevent turbulence and washout of captured pollutants. An internal bypass conveys infrequent peak flows directly to the outlet eliminating the need for, and expense of, external bypass control structures. A floatables draw off slot functions to convey floatables into the treatment chamber prior to bypass.

Verified by NJCAT and NJDEP

Fig.1 The First Defense® High Capacity has internal components designed to efficiently capture pollutants and prevent washout at peak flows.

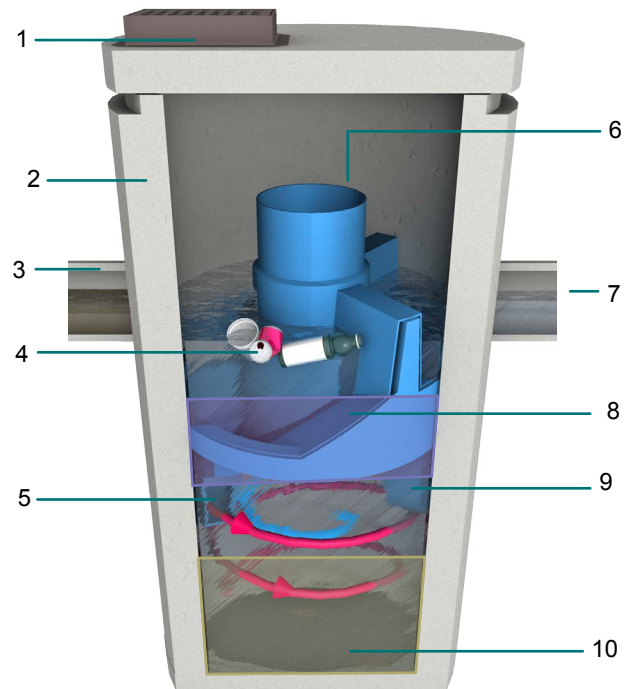

Components

- | | |
|---|-------------------------------|
| 1. Inlet Grate (optional) | 6. Internal Bypass |
| 2. Precast chamber | 7. Outlet pipe |
| 3. Inlet Pipe (optional) | 8. Oil and Floatables Storage |
| 4. Floatables Draw Off Slot
(not pictured) | 9. Outlet chute |
| 5. Inlet Chute | 10. Sediment Storage Sump |

First Defense® High Capacity

Sizing & Design

This adaptable online treatment system works easily with large pipes, multiple inlet pipes, inlet grates and now, contains a high capacity bypass for the conveyance of large peak flows. Designed with site flexibility in mind, the First Defense® High Capacity allows engineers to maximize available site space without compromising treatment level.

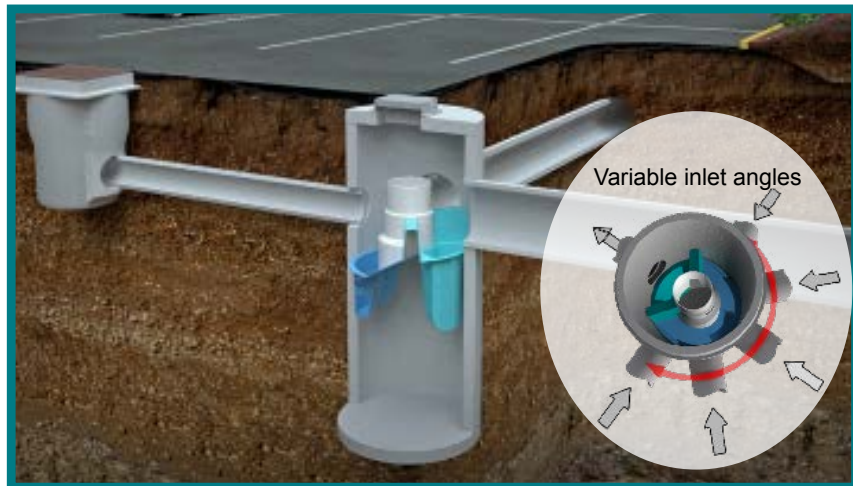

Fig 2. Works with multiple inlet pipes and grates

Inspection and Maintenance

Nobody maintains our systems better than we do. To ensure optimal, ongoing device performance, be sure to recommend Hydro International as a preferred service and maintenance provider to your clients.

Call **1 (800) 848-2706** to schedule an inspection and cleanout or learn more at hydro-int.com/service

Free Stormwater Separator Sizing Calculator for Engineers



This simple online tool will recommend the best separator, model size and online/offline arrangement based on site-specific data entered by the user.

Go to hydro-int.com/sizing to access the tool.



Fig 3. Maintenance is done with a vector truck

Table 1. First Defense® High Capacity Design Criteria.

First Defense® High Capacity Model Number	Diameter	Typical TSS Treatment Flow Rates			Peak Online Flow Rate	Maximum Pipe Diameter ¹	Oil Storage Capacity	Typical Sediment Storage Capacity ²	Minimum Distance from Outlet Invert to Top of Rim ³	Standard Distance from Outlet Invert to Sump Floor
		NJDEP Certified	106µm	230µm						
	(ft / m)	(cfs / L/s)	(cfs / L/s)	(cfs / L/s)	(cfs / L/s)	(in / mm)	(gal / L)	(yd ³ / m ³)	(ft / m)	(ft / m)
FD-3HC	3 / 0.9	0.84 / 23.7	0.3 / 8.77	0.53 / 15.0	15 / 424	18 / 457	125 / 473	0.4 / 0.3	2.0 - 3.5 / 0.6 - 1.0	3.71 / 1.13
FD-4HC	4 / 1.2	1.50 / 42.4	0.7 / 20	1.2 / 34	18 / 510	24 / 600	191 / 723	0.7 / 0.5	2.3 - 3.9 / 0.7 - 1.2	4.97 / 1.5
FD-5HC	5 / 1.5	2.34 / 66.2	1.3 / 37.9	2.2 / 62.2	20 / 566	24 / 609	300 / 1135	1.1 / .84	2.5 - 4.5 / 0.7 - 1.3	5.19 / 1.5
FD-6HC	6 / 1.8	3.38 / 95.7	2.2 / 63	3.8 / 108	32 / 906	30 / 750	496 / 1,878	1.6 / 1.2	3.0 - 5.1 / 0.9 - 1.6	5.97 / 1.8
FD-8HC	8 / 2.4	6.00 / 169.9	5.1 / 144	8.6 / 243	50 / 1,415	48 / 1219	1120 / 4239	2.8 / 2.1	3.0 - 6.0 / 0.9 - 1.8	7.40 / 2.2

¹Contact Hydro International when larger pipe sizes are required.

²Contact Hydro International when custom sediment storage capacity is required.

³Minimum distance for models depends on pipe diameter.



State of New Jersey

DEPARTMENT OF ENVIRONMENTAL PROTECTION

Bureau of Nonpoint Pollution Control

Division of Water Quality

401-02B

Post Office Box 420

Trenton, New Jersey 08625-0420

609-633-7021 Fax: 609-777-0432

http://www.state.nj.us/dep/dwq/bnpc_home.htm

CHRIS CHRISTIE
Governor

KIM GUADAGNO
Lt. Governor

BOB MARTIN
Commissioner

April 4, 2016

Lisa Lemont, CPSWQ
Business Development Manager
Hydro International
94 Hutchins Drive
Portland, ME 04102

Re: MTD Lab Certification
First Defense® HC (FDHC) Stormwater Treatment Device by Hydro International

TSS Removal Rate 50%

Dear Ms. Lemont:

The Stormwater Management rules under N.J.A.C. 7:8-5.5(b) and 5.7 (c) allow the use of manufactured treatment devices (MTDs) for compliance with the design and performance standards at N.J.A.C. 7:8-5 if the pollutant removal rates have been verified by the New Jersey Corporation for Advanced Technology (NJCAT) and have been certified by the New Jersey Department of Environmental Protection (NJDEP). Hydro International has requested an MTD Laboratory Certification for the First Defense® HC Stormwater Treatment Device.

The projects falls under the "Procedure for Obtaining Verification of a Stormwater Manufactured Treatment Device from New Jersey Corporation for Advance Technology" dated January 25, 2013. The applicable protocol is the "New Jersey Laboratory Testing Protocol to Assess Total Suspended Solids Removal by a Hydrodynamic Sedimentation Manufactured Treatment Device" dated January 25, 2013.

NJCAT verification documents submitted to the NJDEP indicate that the requirements of the aforementioned protocol have been met or exceeded. The NJCAT letter also included a recommended certification TSS removal rate and the required maintenance plan. The NJCAT Verification Report with the Verification Appendix (dated February 2016) for this device is published online at <http://www.njcat.org/verification-process/technology-verification-database.html>.

The NJDEP certifies the use of the First Defense® HC Stormwater Treatment Device by Hydro International at a TSS removal rate of 50% when designed, operated and maintained in accordance with the information provided in the Verification Appendix and the following conditions:

1. The maximum treatment flow rate (MTFR) for the manufactured treatment device (MTD) is calculated using the New Jersey Water Quality Design Storm (1.25 inches in 2 hrs) in N.J.A.C. 7:8-5.5.

2. The First Defense® HC Stormwater Treatment Device shall be installed using the same configuration reviewed by NJCAT and shall be sized in accordance with the criteria specified in item 6 below.
3. This First Defense® HC Stormwater Treatment Device cannot be used in series with another MTD or a media filter (such as a sand filter) to achieve an enhanced removal rate for total suspended solids (TSS) removal under N.J.A.C. 7:8-5.5.
4. Additional design criteria for MTDs can be found in Chapter 9.6 of the New Jersey Stormwater Best Management Practices (NJ Stormwater BMP) Manual which can be found on-line at www.njstormwater.org.
5. The maintenance plan for a site using the First Defense® HC Stormwater Treatment Device shall incorporate, at a minimum, the maintenance requirements noted in the attached document. However, it is recommended to review the maintenance website at http://www.hydro-int.com/UserFiles/downloads/FD_O%2BM_F1512.pdf for any changes to the maintenance requirements.
6. Sizing Requirements:

The example below demonstrates the sizing procedure for the First Defense® HC Stormwater Treatment Device:

Example: A 0.25 acre impervious site is to be treated to 50% TSS removal using a First Defense® HC Stormwater Treatment Device. The impervious site runoff (Q) based on the New Jersey Water Quality Design Storm was determined to be 0.79 cfs.

Maximum Treatment Flow Rate (MTFR) Evaluation:

The site runoff (Q) was based on the following:

time of concentration = 10 minutes

i=3.2 in/hr (page 5-8, Fig. 5-3 of the NJ Stormwater BMP Manual)

c=0.99 (curve number for impervious)

$Q=ciA=0.99 \times 3.2 \times 0.25 = 0.79$ cfs

Given the site runoff is 0.79 cfs and based on Table 1 below, the First Defense® HC Model 4-ft with a MTFR of 1.5 cfs would be the smallest model approved that could be used for this site that could remove 50% of the TSS from the impervious area without exceeding the MTFR.

The sizing table corresponding to the available system models is noted below. Additional specifications regarding each model can be found in the Verification Appendix under Table A-1 and Table A-2 of the NJCAT Verification Report.

Table 1 First Defense® HC Models

First Defense® Model	Manhole Diameter (ft)	Maximum Treatment Flowrate, MTFR (cfs)
4-ft	4-ft	1.50
6-ft	6-ft	3.38
8-ft	8-ft	6.00

Be advised a detailed maintenance plan is mandatory for any project with a Stormwater BMP subject to the Stormwater Management Rules, N.J.A.C. 7:8. The plan must include all of the items identified in the Stormwater Management Rules, N.J.A.C. 7:8-5.8. Such items include, but are not limited to, the list of inspection and maintenance equipment and tools, specific corrective and preventative maintenance tasks, indication of problems in the system, and training of maintenance personnel. Additional information can be found in Chapter 8: Maintenance of the New Jersey Stormwater Best Management Practices Manual.

If you have any questions regarding the above information, please contact Mr. Titus Magnanao of my office at (609) 633-7021.

Sincerely,

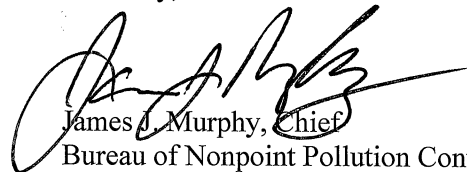

James J. Murphy, Chief
Bureau of Nonpoint Pollution Control

Attachment: Maintenance Plan

C: Chron File
Richard Magee, NJCAT
Vince Mazzei, DLUR
Ravi Patraju, NJDEP
Gabriel Mahon, BNPC
Titus Magnanao, BNPC

PART 1 - GENERAL**1.01 SCOPE**

- A. Work described in this section includes furnishing all labor, equipment, materials, tools and incidentals required for a complete and operable installation of the First Defense® stormwater treatment system as shown on the drawings and specified herein.
- B. The manufacturer shall design and supply the equipment listed herein and the Contractor shall install the equipment in accordance with the manufacturer's Handling, Storage, and Installation Instructions.

1.02 GENERAL REQUIREMENTS

- A. The treatment system shall use an induced vortex to separate pollutants from stormwater runoff. The system shall be self-activating with no mechanical parts or external power requirements.
- B. Upon request, independently certified performance data and references shall be made available to the Engineer of Record for use in determining that the treatment system meets the design criteria and performance requirements stated herein.

1.03 SUBMITTALS

- A. Submittals shall be provided and shall include the following:
 - i. Site plan showing location and orientation of proposed pipe sizes, connections and excavation limits.
 - ii. Product installation drawings showing plan and elevation views with water elevations for the flow conditions specified herein.
 - iii. Performance data as required in Part 2.
 - iv. Inspection and maintenance procedures.

1.04 QUALITY ASSURANCE

- A. The treatment system shall be manufactured under the direction of an ISO 9001 Certified Company.
- B. Inspection

The treatment system shall be subject to inspection by the Engineer of Record or the owner's representative at either the place of manufacture or the project site. Any and all observed defects shall be repaired to the satisfaction of the owner or owner's representative or replacement shall be made available.

C. Warranty

The manufacturer shall guarantee the treatment system free from defects in materials and workmanship for a period of two years following installation. If during the warranty period defects in materials or workmanship are noted, then the manufacturer shall be promptly notified. The decision to repair or replace affected units shall be made at the discretion of the manufacturer.

D. Patent Indemnity

Upon request, the manufacturer shall warrant that the treatment system does not infringe upon or violate any patent, copyright, trade secret or any other proprietary right of any third party and shall indemnify the Owner against any loss, cost, expense or liability arising out of such claim whether or not such claim is successful.

E. Certificate of Compliance

Upon request, the manufacturer shall provide a "Letter of Certification" to certify that the treatment system adheres to the specifications required herein and complies with the project's stormwater management permit.

1.05 MANUFACTURER

- A. The treatment system shall be supplied by a manufacturer regularly engaged in such work who has furnished similar installations that have been in successful and continuous operation for a minimum period of five years. The manufacturer shall be a Stormwater Equipment Manufacturer Association (SWEMA) member.
- B. The treatment system shall be certified by an acceptable State agency, such as a State Department of Environmental Protection (DEP) or industry verification or assessment agency (e.g.: ETV, NJCAT, NETE, MaSTEP).

PART 2 – STORMWATER HVS

2.01 General

- A. The treatment system shall use a tangential inlet chute to establish rotational flow within a cylindrical vortex chamber and be able to treat the Water Quality Flow Rate stated herein without re-suspending and releasing captured pollutants. The treatment system shall not release captured floating pollutants during surcharge conditions.
- B. The treatment system shall not exceed the pressure drop (headloss) for the design flow rates specified herein as determined by ASTM C1745 / C1745M – 11.
- C. The treatment system shall fit within the limits of excavation (area and depth) as shown in the project plans and will not exceed the dimensions for the design flow rates specified herein.
- D. The storage capacities for pollutants that settle (sediment) and float (oil) shall not be less than the volumes listed in Table 1. The treatment system shall operate as

intended and perform as specified herein as pollutants accumulate. The accumulation of pollutants that settle shall not reduce the volume required in the treatment system for separation and for preventing re-suspension and washout, or reduce the floatables storage volume capacity.

- E. Minimum 24-inch frame and cover shall provide access to the sediment storage volumes from the surface for inspection and maintenance. Removal of pollutants from the treatment system shall be possible without requiring confined space entry.

2.02 Performance

- A. Performance of the treatment system shall be based on independent full-scale laboratory testing and shall adhere to the Performance Specifications listed in Table 1. The laboratory testing used as the basis of product performance shall be undertaken in accordance with testing protocols approved or endorsed by SWEMA or acceptable State agency, such as a State Department of Environmental Protection (DEP) or recognized verification agency (e.g.: ETV, NJCAT, NETE, MaSTEP).
- B. Performance of the treatment system shall be based on treating the Water Quality Flow rate (WQF) without internally bypassing and without re-suspension and washout of captured pollutants (scour). The Maximum Treatment Flow Rate(s) (MTFR-106 and/or MTFR-230) shall be greater than or equal to the WQF. The treatment system shall remove greater than or equal to 90% of TSS based on the Target Particle Size (TPS) of 106 microns and/or 80% of TSS based on the TPS of 230 microns at MTFR-106 and MTFR-230, respectively.
- C. The treatment system shall convey the Peak On-line Flow Rates listed in Table 1 without causing upstream surcharge conditions. Full-scale independent laboratory scour testing shall demonstrate effluent control of less than or equal to 5 mg/L for all flows up to 200% of MTFR-106.
- D. The treatment system shall be capable of capturing and retaining fine silt and sand size particles. Analysis of captured sediment from full-scale field installations shall demonstrate particle sizes predominately in the 20-micron range.

Table 1.

First Defense® Model	Diameter	Maximum Treatment Flow Rates (MTFR)		Peak Online Flow Rate	Maximum Pipe Diameter	Oil Storage Capacity	Minimum Sediment Storage Capacity	Min. Cover (F/G to Invert)	Min. Depth
		106µm	230µm						
	(ft/m)	(cfs/L/s)	(cfs/L/s)	(cfs /L/s)	(in/mm)	(gal/L)	(yd³/m³)	(ft/m)	(ft/m)
FD-4	4/1.2	0.7/20	1.2/34	6.0/170	18/450	180/681	1.3/ 1.0	3.1/1.1	5.47/1.7
FD-4HC				18.0/510	24/600			2.3-3.9/0.7-1.2	
FD-6	6/1.8	2.2/63	3.8/108	18.0/510	24/600	420/1,590	3.3/ 2.5	4.0 / 1.2	6.52/2.0
FD-6HC				32/906	30/750			3.0-5.1/0.9-1.6	

PART 3 – EQUIPMENT

- A. The treatment system shall be manufactured with materials typically used in stormwater drainage systems that have a minimum life expectancy of 30 years.
- (i) Materials of construction shall be cross-linked polyethylene (XLPE) and/or Type 304 stainless steel or carbon steel powder coated in accordance with ASTM 775/ ASTM A775M. All components shall be designed to withstand normal loadings associated with fabrication, shipping, site installation, and normal operation of the equipment.
 - (ii) Precast shall be manufactured with concrete that has attained a compressive strength of 4,000 psi after 28 days. The structure shall be reinforced to withstand an HS20-44 loading. Shiplap joints shall be sealed with butyl rubber mastic sealant conforming to ASTM C990. Slab tops shall be suitably reinforced and provided with manhole openings and covers as required. The cast iron manhole frames and covers shall be sized as per the manufacturer's drawings and shall be in accordance with ASTM A48, CL.35B and AASHTO M105. The masonry fixing bolts shall be Type 304 stainless steel.
 - (iii) All piping connections and ancillary items not listed herein shall be provided by the Contractor.

PART 4 - EQUIPMENT DELIVERY

- A. The treatment components of the treatment system shall be delivered within six weeks of date of approved technical submittal.
- B. The components of the treatment system shall be preassembled and delivered to the site fully fabricated and ready for the final assembly.
- C. Off-loading, storage, and installation shall be by the Contractor.
- D. The Contractor shall inspect and provide signed acceptance of equipment prior to unloading, or notify the manufacturer of any damage to equipment to effect proper remedial action. Failure to notify the manufacturer of damage to equipment prior to unloading will void all warranties pertaining to subject equipment.

PART 5 - EQUIPMENT INSTALLATION

- A. The system shall be installed in strict accordance with the site plans, and the manufacturer's general arrangement drawings and Handling, Storage and Installation Instructions. The Contractor shall be responsible for installing the equipment and all necessary site connections.

- B. The Manufacturer shall be notified immediately of any equipment which is damaged during unloading, storage, or installation. The damaged equipment shall be repaired or replaced at the discretion of the manufacturer and entirely at the Contractor's expense.
- C. The precast concrete structure shall be set on a granular or compacted sand sub-base in accordance with local requirements for standard manhole installation. In no instances shall the compacted sub-base material have a thickness of less than 12 inches.
- D. The precast concrete structure shall be set level and plumb to within 0.5%.
- E. Non-shrink grout or hydraulic cement conforming to ASTM C 595 shall be used to provide a water tight seal in the lift holes, any drain holes and around the concrete knock-outs for the inlet and outlet pipes.
- F. The Contractor shall, at the discretion of the owner or owner's representative, test the concrete structure for water tightness before backfilling.

Appendix 17 | Erosion and Sediment Control Plan and Details

GENERAL SOIL EROSION AND SEDIMENT CONTROL NOTES

- ALL SOIL EROSION AND SEDIMENT CONTROL PRACTICES ARE TO BE INSTALLED PRIOR TO ANY MAJOR SOIL DISTURBANCE, OR IN THEIR PROPER SEQUENCE AND MAINTAINED UNTIL PERMANENT PROTECTION IS ESTABLISHED.
- ANY DISTURBED AREAS THAT WILL BE LEFT EXPOSED MORE THAN FOURTEEN (14) DAYS FOR DISTURBANCES LESS THAN FIVE (5) ACRES AND SEVEN (7) DAYS FOR DISTURBANCES GREATER THAN FIVE (5) ACRES, AND NOT SUBJECT TO CONSTRUCTION TRAFFIC, WILL IMMEDIATELY RECEIVE A TEMPORARY SEEDING. IF THE SEASON PREVENTS THE ESTABLISHMENT OF TEMPORARY COVER, THE DISTURBED AREAS WILL BE MULCHED WITH STRAW, OR EQUIVALENT MATERIAL, AT A RATE OF TWO (2) TONS PER ACRE, ACCORDING TO STATE STANDARDS.
- PERMANENT VEGETATION TO BE SEED OR SODDED ON ALL EXPOSED AREAS WITHIN FIVE (5) DAYS AFTER FINAL GRADING. MULCHING IS REQUIRED ON ALL SEEDING, WHEN HYDROSEEDING, MULCH SHALL NOT BE INCLUDED IN THE TANK WITH THE SEED.
- ALL WORK TO BE DONE IN ACCORDANCE WITH THE 2016 NEW YORK STANDARDS AND SPECIFICATIONS FOR EROSION AND SEDIMENT CONTROL OR AS AMENDED.
- A SUBBASE COURSE WILL BE APPLIED IMMEDIATELY FOLLOWING ROUGH GRADING AND INSTALLATION OF IMPROVEMENTS TO STABILIZE STREETS, ROADS, DRIVEWAYS, AND PARKING AREAS. IN AREAS WHERE NO UTILITIES ARE PRESENT, THE SUBBASE SHALL BE INSTALLED WITHIN FIVE (5) DAYS OF THE PRELIMINARY GRADING.
- IMMEDIATELY FOLLOWING INITIAL DISTURBANCE OR ROUGH GRADING, ALL CRITICAL AREAS SUBJECT TO EROSION (I.E. STEEP SLOPES AND ROADWAY EMBANKMENTS) WILL RECEIVE A TEMPORARY SEEDING IN COMBINATION WITH STRAW MULCH OR A SUITABLE EQUIVALENT, AT A RATE OF TWO (2) TONS PER ACRE, ACCORDING TO STATE STANDARDS.
- ANY STEEP SLOPES RECEIVING PIPELINE INSTALLATION WILL BE BACKFILLED AND STABILIZED DAILY, AS THE INSTALLATION CONTINUES (I.E. SLOPES GREATER THAN 3:1).
- THE STANDARD FOR STABILIZED CONSTRUCTION ACCESS REQUIRES THE INSTALLATION OF A STONE PAD, AT ALL CONSTRUCTION DRIVEWAYS, IMMEDIATELY AFTER INITIAL SITE DISTURBANCE.
- IN ACCORDANCE WITH THE STANDARD FOR MANAGEMENT OF HIGH ACID PRODUCING SOILS, ANY SOIL HAVING A PH OF 4 OR LESS OR CONTAINING IRON SULFIDES SHALL BE COVERED WITH A MINIMUM OF TWELVE (12) INCHES OF SOIL HAVING A PH OF 5 OR MORE PRIOR TO SEEDBED PREPARATION. AREAS WHERE TREES OR SHRUBS ARE TO BE PLANTED SHALL BE COVERED WITH A MINIMUM OF TWENTY-FOUR (24) INCHES OF SOIL HAVING A PH OF 5 OR MORE.
- AT THE TIME THE SITE PREPARATION FOR PERMANENT VEGETATIVE STABILIZATION IS GOING TO BE ACCOMPLISHED, ANY SOIL THAT WILL NOT PROVIDE A SUITABLE ENVIRONMENT TO SUPPORT ADEQUATE VEGETATIVE GROUND COVER, SHALL BE REMOVED OR TREATED IN SUCH A WAY THAT IT WILL PERMANENTLY ADJUST THE SOIL CONDITIONS AND RENDER IT SUITABLE FOR VEGETATIVE GROUND COVER. IF THE REMOVAL OR TREATMENT OF THE SOIL WILL NOT PROVIDE SUITABLE CONDITIONS, NON-VEGETATIVE MEANS OF PERMANENT GROUND STABILIZATION WILL HAVE TO BE EMPLOYED.
- CONDUIT OUTLET PROTECTION MUST BE REVIEWED & SUPPLEMENTED AT ALL OUTFALLS PRIOR TO THE DRAINAGE SYSTEM BECOMING OPERATIONAL.
- UNFILTERED DEWATERING IS NOT PERMITTED. TAKE ALL NECESSARY PRECAUTIONS DURING ALL DEWATERING OPERATIONS TO MINIMIZE SEDIMENT TRANSFER. ANY DEWATERING METHODS USED MUST BE IN ACCORDANCE WITH STATE STANDARDS.
- SHOULD THE CONTROL OF DUST AT THE SITE BE NECESSARY, THE SITE WILL BE SPRINKLED UNTIL THE SURFACE IS WET. TEMPORARY VEGETATIVE COVER SHALL BE ESTABLISHED OR MULCH SHALL BE APPLIED IN ACCORDANCE WITH STATE STANDARDS FOR EROSION CONTROL.
- ALL SOIL WASHED, DROPPED, SPILLED, OR TRACKED OUTSIDE THE LIMIT OF DISTURBANCE OR ONTO PUBLIC RIGHT-OF-WAY WILL BE REMOVED IMMEDIATELY.
- THE PROPERTY OWNER SHALL BE RESPONSIBLE FOR ANY EROSION AND SEDIMENTATION THAT MAY OCCUR BELOW STORMWATER OUTFALLS OR OFFSITE AS A RESULT OF CONSTRUCTION OF THE PROJECT.
- STOCKPILE AND STAGING LOCATIONS DETERMINED IN THE FIELD, SHALL BE PLACED WITHIN THE LIMITS OF DISTURBANCE ACCORDING TO THE CERTIFIED PLAN.
- CONCRETE WASHOUT, DUMPSTER, & STAGING AREA LOCATIONS SHALL BE DETERMINED BY THE CONTRACTOR AND APPROVED AT THE PRE-CONSTRUCTION MEETING. THEY SHALL BE PLACED IN THE PROXIMITY OF THE CONSTRUCTION ENTRANCE AND STAGING AREAS AND SHALL BE USED PRIOR TO EXITING THE PROJECT SITE. THE LOCATION SHALL BE IN A PRACTICAL, CLEARLY DELINEATED, AREA AND BE MAINTAINED THROUGHOUT CONSTRUCTION.
- ALL SOIL STOCKPILES ARE TO BE TEMPORARILY STABILIZED IN ACCORDANCE WITH THE NEW YORK STATE STANDARDS AND SPECIFICATIONS FOR SOIL EROSION AND SEDIMENT CONTROL.
- ALL PERMANENT SOIL EROSION AND SEDIMENT CONTROL MEASURES SHALL BE MAINTAINED BY THE PROPERTY OWNER, AND SHALL BECOME THEIR RESPONSIBILITY.
- PAVEMENT AREAS ARE TO BE KEPT CLEAN AT ALL TIMES.
- DURING CONSTRUCTION, ANY ADDITIONAL CONTROL MEASURES AS DEEMED NECESSARY TO PREVENT EROSION OR CONTROL SEDIMENT BEYOND THOSE MEASURES SHOWN ON THE APPROVED PLAN SHALL BE INSTALLED OR EMPLOYED AT THE DIRECTION OF THE MUNICIPAL ENGINEER.
- ALL TEMPORARY, STRUCTURAL EROSION AND SEDIMENT CONTROL MEASURES CAN BE REMOVED, WHEN ALL CONSTRUCTION ACTIVITY IDENTIFIED IN THE SWPPP HAS BEEN COMPLETED, ALL AREAS OF DISTURBANCE HAVE ACHIEVED FINAL STABILIZATION** AND ALL POST-CONSTRUCTION STORMWATER MANAGEMENT PRACTICES HAVE BEEN CONSTRUCTED IN CONFORMANCE WITH THE SWPPP AND ARE OPERATIONAL.
- BOTTOM AND BERM ELEVATIONS OF TEMPORARY SEDIMENT BASINS TO BE REVIEWED WITH THE CONTRACTOR BASED ON THEIR PROPOSED CONSTRUCTION SEQUENCE FOR THE PROJECT.
- WASHOUTS, STOCKPILES, AND STAGING AREAS SHOWN FOR SCHEMATIC REFERENCE ONLY. CONTRACTOR TO LOCATE AS NECESSARY TO FACILITATE WORK.
- THE BUILDING SHALL BE STAKED OUT IN THE FIELD PRIOR TO POURING THE FOUNDATION DUE TO THE PROXIMITY TO THE SIDE YARD SETBACK.

LEGEND FOR EROSION CONTROL DURING CONSTRUCTION

- LOD — CONSTRUCTION LIMIT LINE
- S — SILT FENCE
- F — FILTER SOCK
- S — STORM INLET SEDIMENT TRAP
- S — STABILIZED CONSTRUCTION ENTRANCE
- S — STONE OUTLET SEDIMENT TRAP
- S — TEMPORARY SWALE
- S — TEMPORARY SEDIMENT BASIN
- S — MATERIAL STOCKPILE
- S — CONCRETE WASHOUT
- S — CHECK DAM

**FINAL STABILIZATION - MEANS THAT ALL SOIL DISTURBANCE ACTIVITIES HAVE CEASED AND A UNIFORM, PERENNIAL VEGETATIVE COVER WITH A DENSITY OF EIGHTY (80) PERCENT OVER THE ENTIRE PERVIOUS SURFACE HAS BEEN ESTABLISHED, OR OTHER EQUIVALENT STABILIZATION MEASURES, SUCH AS PERMANENT LANDSCAPE MULCHES, ROCK RIP-RAP OR WASHED/CRUSHED STONE HAVE BEEN APPLIED ON ALL DISTURBED AREAS THAT ARE NOT COVERED BY PERMANENT STRUCTURES, CONCRETE OR PAVEMENT.

MAINTENANCE PLAN DURING CONSTRUCTION:

INSPECTION AND MAINTENANCE SHALL BE PERFORMED IN CONFORMANCE WITH GP-0-20-001 OR AS AMENDED. ALL EROSION AND SEDIMENT CONTROL PRACTICES WILL BE CHECKED FOR STABILITY AND OPERATION FOLLOWING EVERY RUNOFF-PRODUCING RAINFALL, BUT IN NO CASE LESS THAN ONCE EVERY WEEK. ANY NEEDED REPAIRS WILL BE MADE IMMEDIATELY TO MAINTAIN ALL PRACTICES AS DESIGNED AND INSTALLED FOR THE PROJECT. THE SEDIMENT TRAPS WILL BE CLEANED OUT WHEN THE LEVEL OF SEDIMENT REACHES 25% OF ITS CAPACITY. SEDIMENT WILL BE REMOVED FROM BEHIND THE SILT FENCE WHEN IT BECOMES APPROXIMATELY 6" DEEP AT THE FENCE. THE SILT FENCE WILL BE REPAIRED AS NECESSARY TO MAINTAIN A BARRIER. ALL SEEDED AREAS WILL BE FERTILIZED, RE-SEED AS NECESSARY, AND MULCHED ACCORDING TO SPECIFICATIONS IN THE LANDSCAPE PLAN TO MAINTAIN A VIGOROUS, DENSE VEGETATIVE COVER.

MAINTENANCE AGREEMENT NOTE:

THE OWNER/APPLICANT SHALL ENTER INTO AN ENFORCEABLE MAINTENANCE AGREEMENT WITH THE MUNICIPALITY (IF AN MSA COMMUNITY) RELATED TO MAINTENANCE OF STORMWATER FACILITIES. THE OWNER/APPLICANT IS RESPONSIBLE TO PERFORM ALL REQUIRED MAINTENANCE BOTH DURING CONSTRUCTION AND LONG TERM. THE NATURE OF THE AGREEMENT IS TO ALLOW THE MUNICIPALITY TO PERFORM MAINTENANCE AT THEIR OPTION SHOULD THE OWNER/APPLICANT FAIL TO ADEQUATELY MAINTAIN THE SYSTEM AS DETERMINED BY THE MUNICIPAL ENGINEER. MAINTENANCE OF THE STORMWATER SYSTEM SHALL BE PERFORMED IN ACCORDANCE WITH THE APPROVED SWPPP AND DETAIL SHEETS.

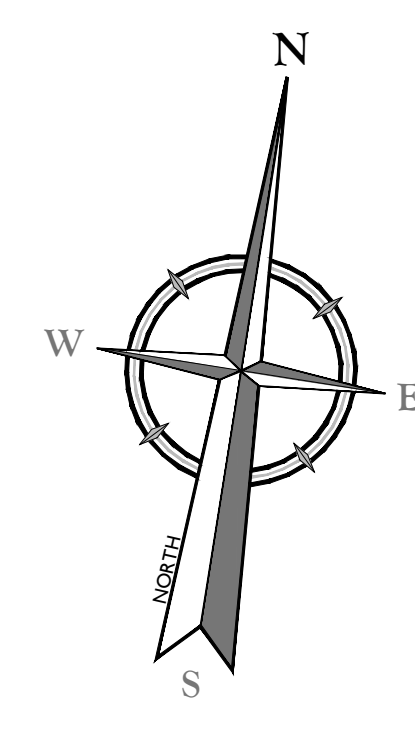
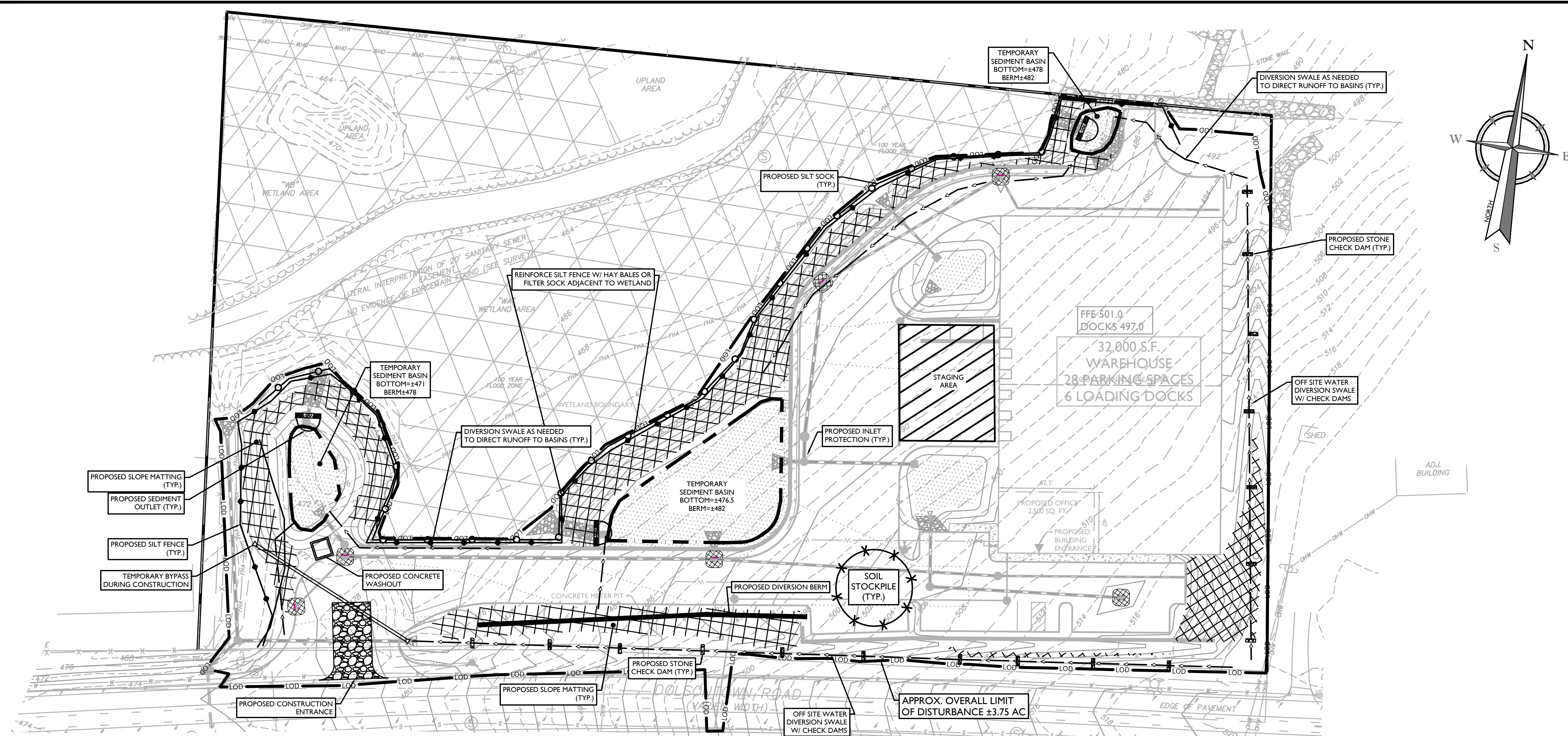

- NOTES:**
- GEOTEXTILE TO BE WOVEN POLYPROPYLENE PRODUCT, OR APPROVED EQUAL.
 - FILLER CORE MAY BE SAND, COMPOST, OR PEA GRAVEL COMPLETELY CONTAINED WITHIN GEOTEXTILE SEAMS, CLOSED BY SUITABLE MECHANICAL MEANS TO PREVENT LEAKAGE OF FILLER.
 - WHERE NO CURB IS PRESENT, BARRIER SHALL COMPLETELY ENCLOSE THE DRAIN INLET.
 - INLET GRATE OPENING IS TO BE KEPT CLEAR OF OBSTRUCTIONS AT ALL TIMES.
 - THE PROTECTION DEVICE WILL BE DESIGNED TO CAPTURE OR FILTER RUNOFF FROM THE 1 YEAR/24 HOUR STORM EVENT AND SHALL SAFELY CONVEY HIGHER FLOWS DIRECTLY INTO THE STORM SEWER SYSTEM.
 - OTHER METHODS THAT ACCOMPLISH THE PURPOSE OF STORM SEWER INLET PROTECTION MAY BE USED IF APPROVED BY THE PROJECT ENGINEER.
 - INSPECTIONS SHALL BE FREQUENT, MAINTENANCE, REPAIR, AND REPLACEMENT SHALL BE MADE PROMPTLY AS NEEDED, THE BARRIER SHALL BE REMOVED WHEN THE AREA DRAINING TOWARDS THE INLET HAS REACHED FINAL STABILIZATION.

303 (D) - SEGMENTS IMPAIRED BY CONSTRUCTION RELATED POLLUTANTS

- FOR CONSTRUCTION SITE THAT DIRECTLY DISCHARGE TO ONE OF THE 303(D) SEGMENTS LISTED IN APPENDIX E OF THE GP-0-20-001 OR IS LOCATED IN ONE OF THE WATERSHEDS LISTED IN APPENDIX C OF THE GP-0-20-001, THE QUALIFIED INSPECTOR MUST CONDUCT AT LEAST TWO (2) SITE INSPECTIONS EVERY SEVEN (7) CALENDAR DAYS. THE TWO (2) INSPECTIONS MUST BE SEPARATED BY A MINIMUM OF TWO (2) FULL CALENDAR DAYS.
- FOR CONSTRUCTION SITES THAT DIRECTLY DISCHARGE TO ONE OF THE 303(D) SEGMENTS LISTED IN APPENDIX E OF THE GP-0-20-001 OR IS LOCATED IN ONE OF THE WATERSHEDS LISTED IN APPENDIX C OF THE GP-0-20-001, THE APPLICATION OF SOIL STABILIZATION MEASURES MUST BE INITIATED BY THE END OF THE NEXT BUSINESS DAY AND COMPLETED WITHIN SEVEN (7) DAYS.
- THE PROJECT SITE DISCHARGES TO THE MONHAGEN BROOK LISTED IN APPENDIX E OF THE GP-0-20-001.

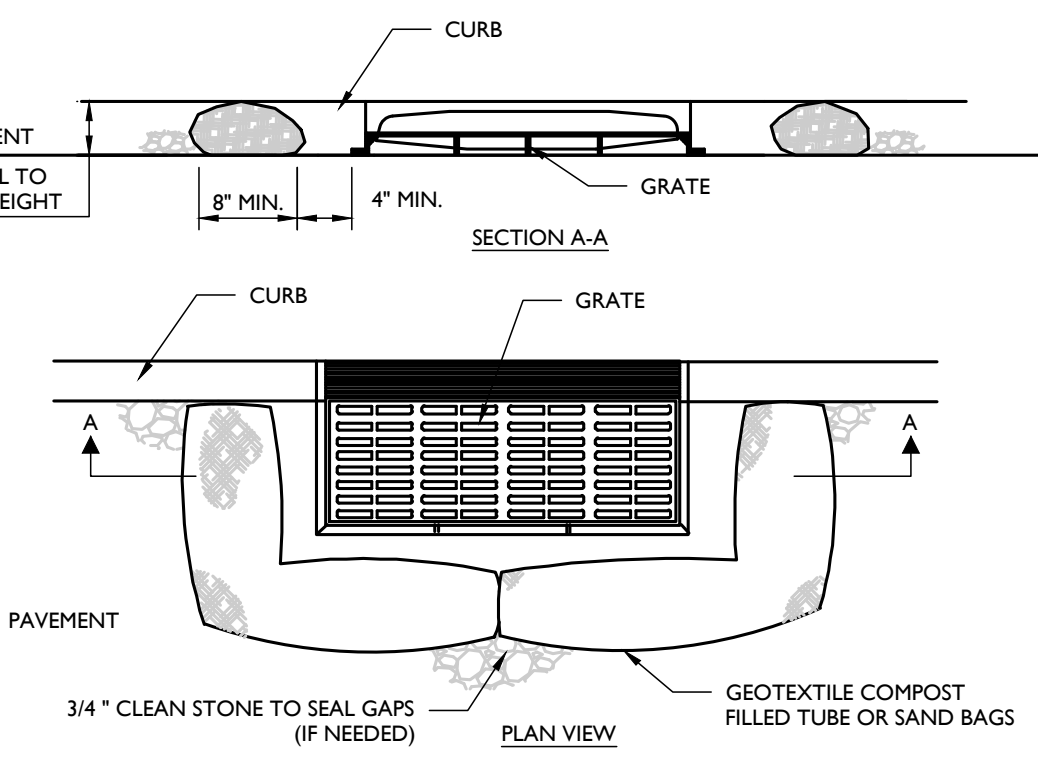

INLET PROTECTION (FILTER BARRIER) DETAIL

UNAUTHORIZED ALTERATION OR ADDITION TO A SURVEY OR ENGINEERING MAP BEARING A LICENSED LAND SURVEYOR OR PROFESSIONAL ENGINEER IS A VIOLATION OF SECTION 7209, SUB-DIVISION 2, OF THE NEW YORK STATE EDUCATION LAW. ONLY MAPS WITH THE LAND SURVEYOR OR PROFESSIONAL ENGINEER'S SEAL ARE GENUINE TRUE AND CORRECT COPIES OF THE LAND SURVEYOR OR PROFESSIONAL ENGINEER'S ORIGINAL WORK AND OPINION.

www.colliersengineering.com

Copyright © 2025, Colliers Engineering & Design All Rights Reserved. This drawing and all the information contained herein is authorized for use only by the party for whom the services were contracted or to whom it is certified. This drawing may not be copied, reused, modified, distributed or relied upon for any other purpose without the express written consent of Colliers Engineering & Design.

Doing Business as

PROTECT YOURSELF
ALL STATES REQUIRE NOTIFICATION OF EXCAVATIONS, DESIGNERS, OR ANY PERSON PREPARING TO DISTURB THE EARTH'S SURFACE ANYWHERE IN ANY STATE.
Know what's below.
Call before you dig.
FOR STATE SPECIFIC DIRECT PHONE NUMBERS VISIT: WWW.CALL811.COM

REV.	DATE	DRAWN BY	DESCRIPTION
1	02/04/22	CDR	REVISED WETLAND IMPACT REDUCTION AND DETAILS FOR GES SUBMISSION.
2	01/13/23	CDR	REVISED PER STORMWATER TESTING & PLANNING BOARD COMMENTS.
3	06/15/24	TPS	REVISED PER REMOVAL OF SUBSURFACE STORMWATER TREATMENT.
4	07/21/24	TPS	REVISED PER PLANNING BOARD COMMENTS.
5	01/29/25	TPS	REVISED PER PLANNING BOARD COMMENTS.

Cory Daniel Robinson
NEW YORK LICENSED PROFESSIONAL ENGINEER
LICENSE NUMBER: 103788
COLLIERS ENGINEERING & DESIGN CT, P.C.
N.Y. C.O.A.#: 0017609

PRELIMINARY SITE PLAN

FOR
DEWPOINT NORTH LLC

**SECTION 4
BLOCK 1
LOT 50.2**

**TOWN OF WAWAYANDA
ORANGE COUNTY
NEW YORK STATE**

555 Hudson Valley Avenue, Suite 101, New Windsor, NY 12553
Phone: 845.564.4495
COLLIERS ENGINEERING & DESIGN, ARCHITECTURAL ARCHITECTURE SURVEYING, P.C., DOING BUSINESS AS MASER CONSULTING ENGINEERS & LAND SURVEYORS

SCALE: AS SHOWN DATE: 01/10/2022 DRAWN BY: MAS CHECKED BY: CDR
PROJECT NUMBER: 2000912A DRAWING NAME: C-SESC-NRTH

SHEET TITLE: **SOIL EROSION & SEDIMENT CONTROL PLAN**

SHEET NUMBER: **C-600**

NOTE: DO NOT SCALE DRAWINGS FOR CONSTRUCTION.

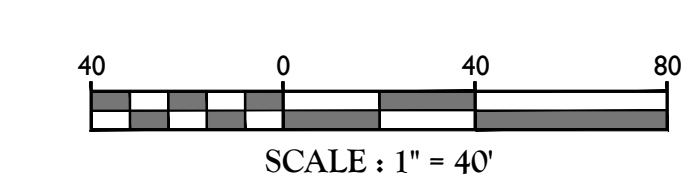

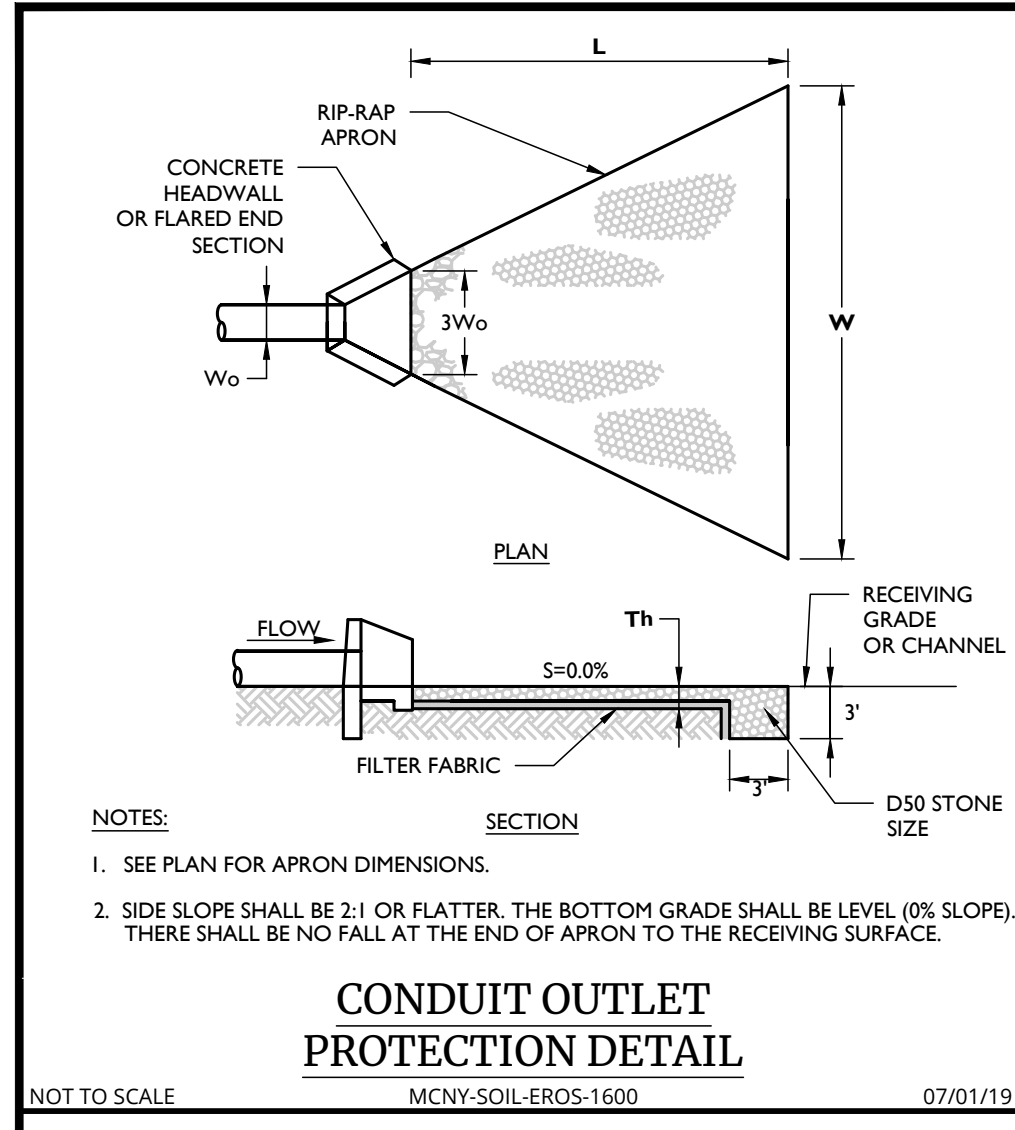

NOTES:

- SEE PLAN FOR APRON DIMENSIONS.
- SIDE SLOPE SHALL BE 2:1 OR FLATTER. THE BOTTOM GRADE SHALL BE LEVEL (0% SLOPE). THERE SHALL BE NO FALL AT THE END OF APRON TO THE RECEIVING SURFACE.

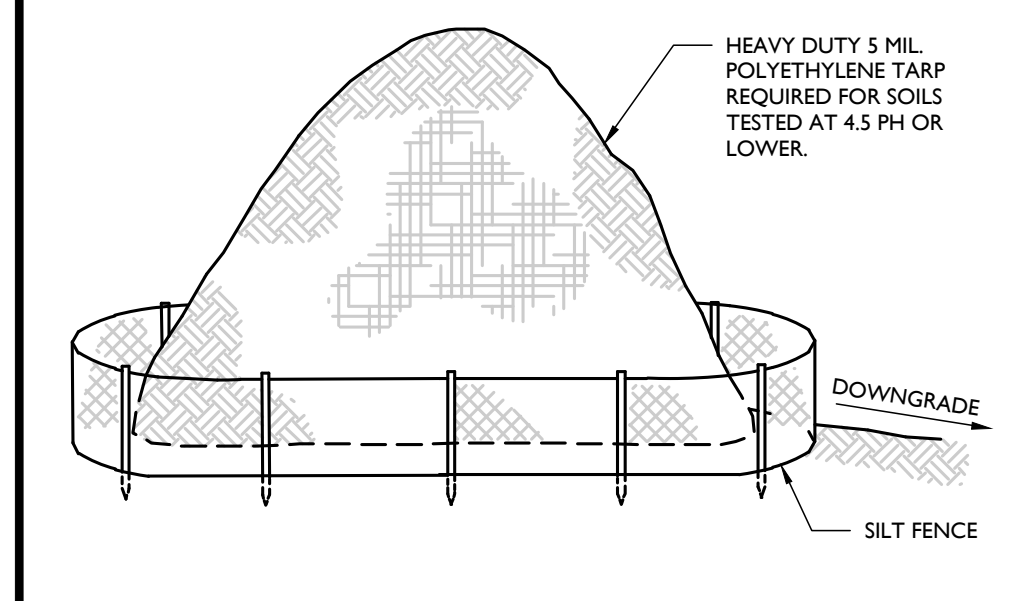

- NOTES:
- ALL STOCKPILES SHALL NOT BE LOCATED WITHIN 50 FEET OF A FLOODPLAIN, SLOPE, ROADWAY OR DRAINAGE FACILITY.

NOT TO SCALE

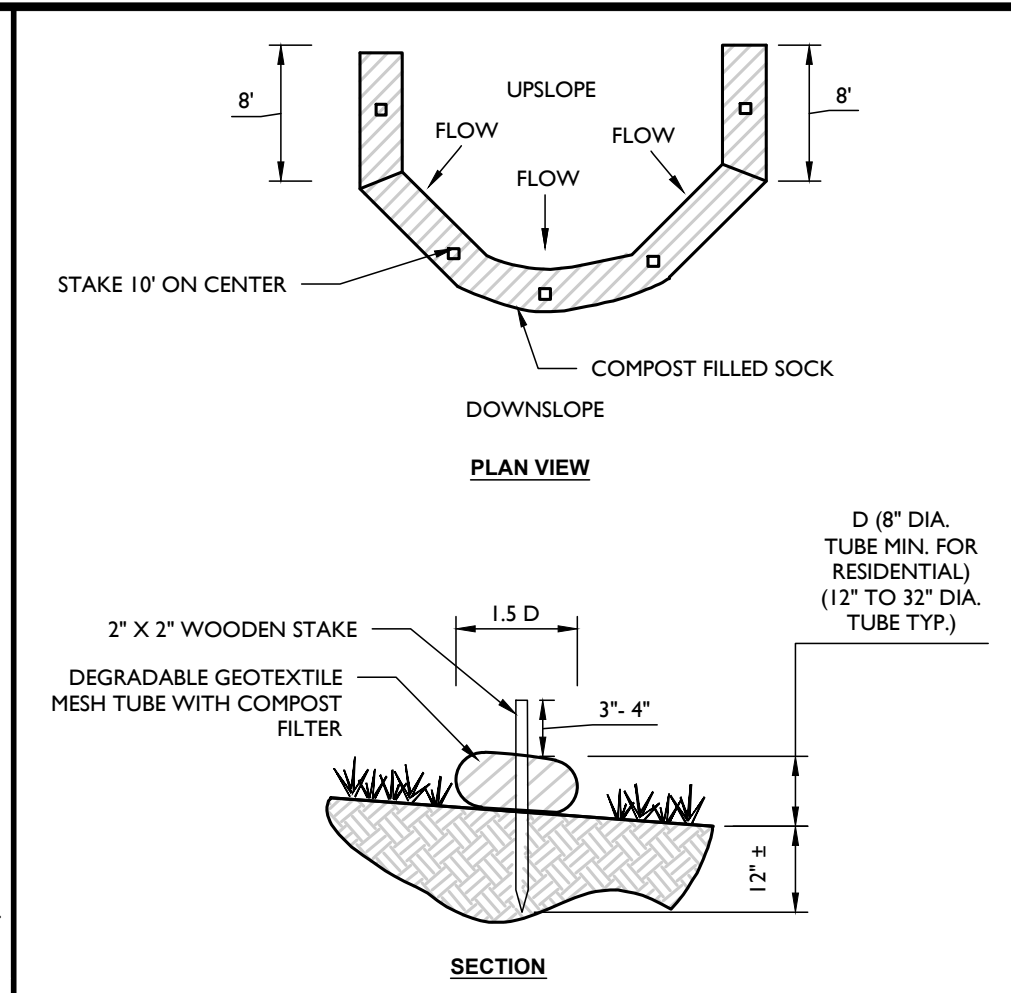

DIA. (in.)	SLOPE%					
	2	5	10	20	25	33
8	225*	200	100	50	20	-
12	250	225	125	65	50	40
18	275	250	150	70	55	45
24	350	275	200	130	100	60
32	450	325	275	150	120	75

*Length in feet

- NOTES:
- ALL MATERIAL TO MEET **FILTREXX SILT-SOX** SPECIFICATIONS OR APPROVED EQUAL.
 - COMPOST/SOIL/ROCK/SEED FILL TO MEET APPLICATION REQUIREMENTS.
 - COMPOST MATERIAL TO BE DISPERSED ON SITE, AS DETERMINED BY ENGINEER.

COMPOST FILTER SOCK DETAIL
MCNY-SOIL-EROS-1200 05/01/17



- CONSTRUCTION SPECIFICATIONS:
- STONE WILL BE PLACED ON A FILTER FABRIC FOUNDATION TO THE LINES, GRADES AND LOCATIONS SHOWN ON THE PLAN.
 - SET SPACING OF CHECK DAMS TO ASSUME THAT THE ELEVATIONS OF THE CREST OF THE DOWNSTREAM DAM IS AT THE SAME ELEVATION OF THE TOE OF THE UPSTREAM DAM.
 - EXTEND THE STONE A MINIMUM OF 1.5 FEET BEYOND THE DITCH BANKS TO PREVENT CUTTING AROUND THE DAM.
 - PROTECT THE CHANNEL DOWNSTREAM OF THE LOWEST CHECK DAM FROM SCOUR AND EROSION WITH STONE OR LINER AS APPROPRIATE.
 - ENSURE THAT CHANNEL APPURTENANCES SUCH AS CULVERT ENTRANCES BELOW CHECK DAMS ARE NOT SUBJECT TO DAMAGE OR BLOCKAGE FROM DISPLACED STONE.
- MAXIMUM DRAINAGE AREA: 2 ACRES

NOT TO SCALE

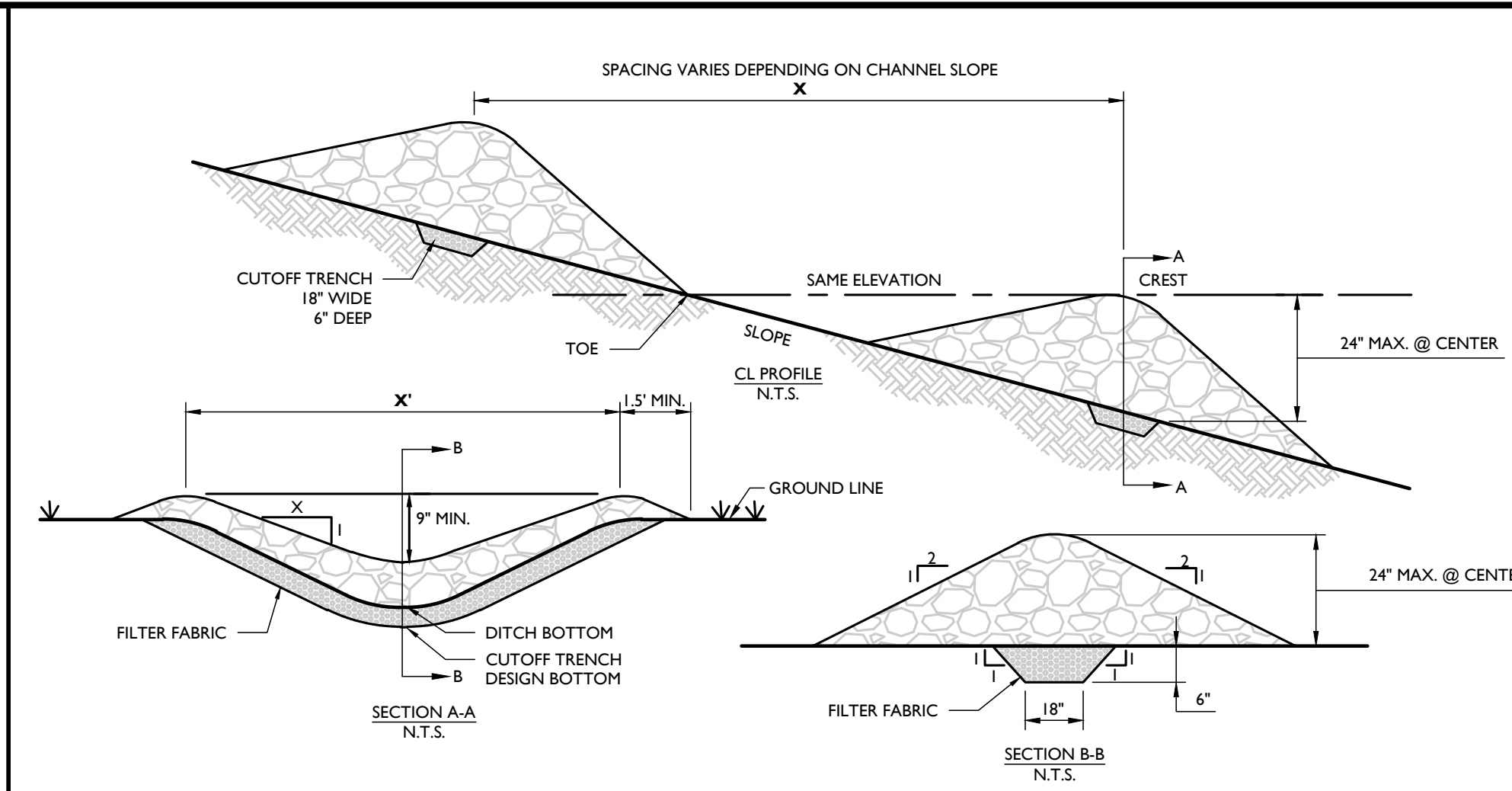

- NOTES:
- STONE SIZE - USE 2\"/>

NOT TO SCALE

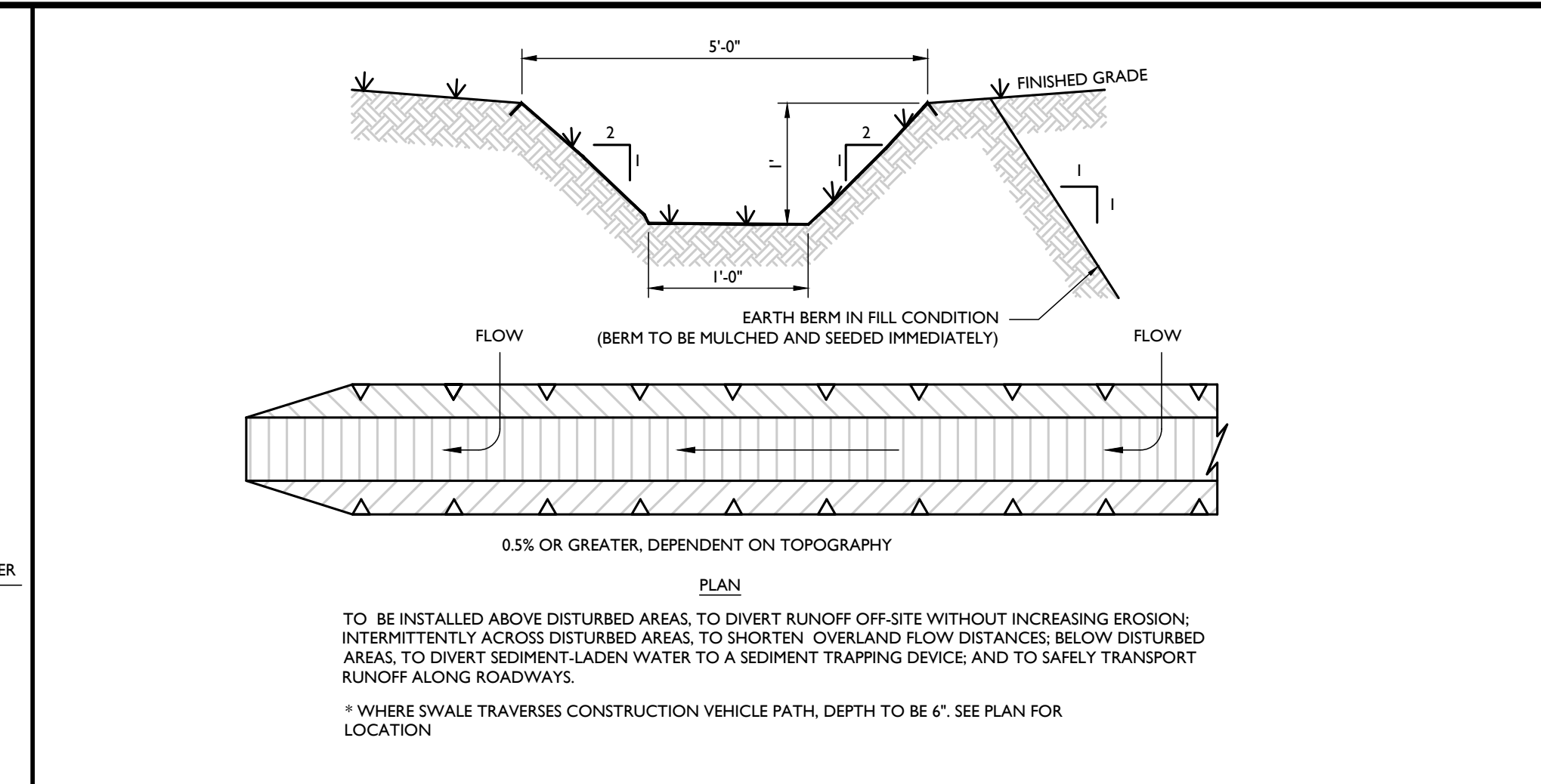

- INSTALLATION NOTES:
- ALL SWALES SHALL HAVE UNINTERRUPTED POSITIVE GRADE TO AN OUTLET.
 - DIVERTED RUNOFF FROM A DISTURBED AREA SHALL BE CONVEYED TO A SEDIMENT TRAPPING DEVICE.
 - DIVERTED RUNOFF FROM AN UNDISTURBED AREA SHALL OUTLET DIRECTLY INTO AN UNDISTURBED STABILIZED AREA AT NON-EROSIVE VELOCITY.
 - ALL TREES, BRUSH, STUMPS, OBSTRUCTIONS AND OTHER OBJECTIONABLE MATERIAL SHALL BE REMOVED AND DISPOSED OF SO AS NOT TO INTERFERE WITH THE PROPER FUNCTIONING OF THE SWALE.
 - THE SWALE SHALL BE EXCAVATED OR SHAPED TO LINE, GRADE AND CROSS SECTION AS REQUIRED TO MEET THE CRITERIA SPECIFIED HEREIN AND BE FREE OF BANK PROJECTIONS OR OTHER IRREGULARITIES WHICH WILL IMPEDE NORMAL FLOW.
 - FILLS SHALL BE COMPACTED BY EARTH MOVING EQUIPMENT.
 - ALL EARTH REMOVED AND NOT NEEDED FOR CONSTRUCTION SHALL BE PLACED SO AS NOT TO INTERFERE WITH THE FUNCTIONING OF THE SWALE.
 - INSPECTION AND MAINTENANCE MUST BE PROVIDED BY THE CONTRACTOR AS REQUIRED.
 - STABILIZATION SHALL BE SEED AND STRAW MULCH.

NOT TO SCALE

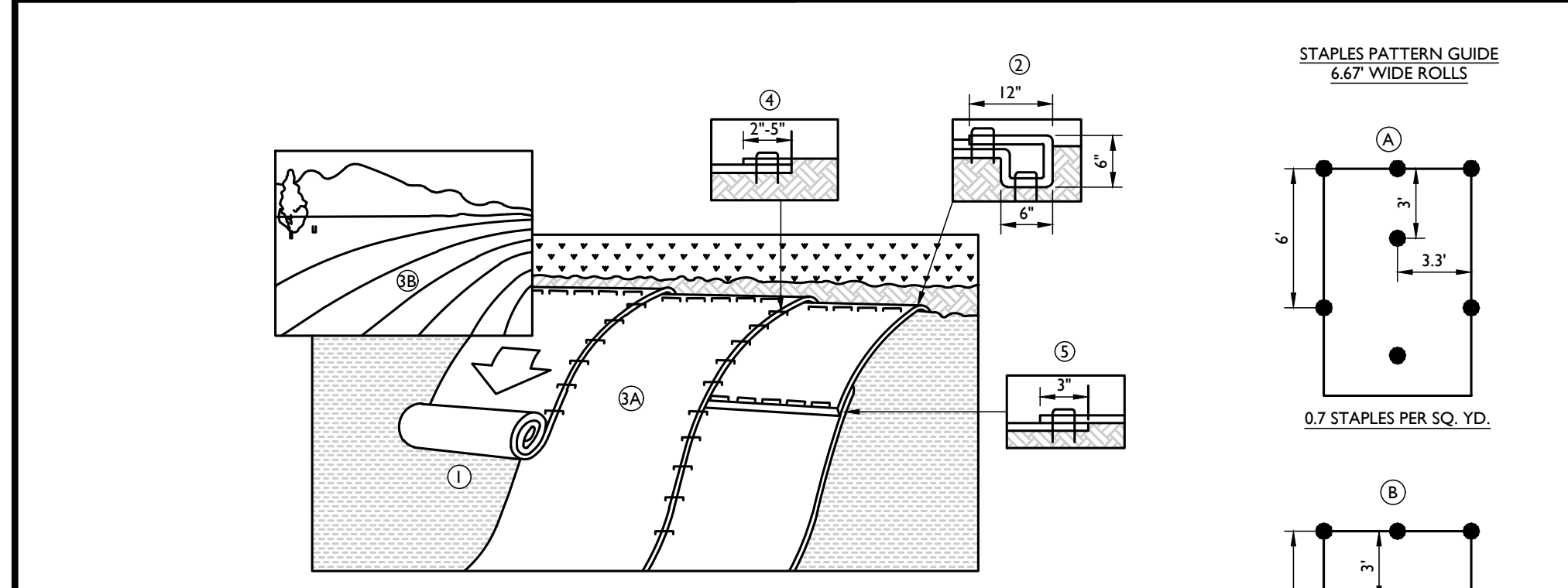

- NOTES:
- PREPARE SOIL BEFORE INSTALLING ROLLED EROSION CONTROL PRODUCTS (RECPs), INCLUDING ANY NECESSARY APPLICATION OF LIME, FERTILIZER AND SEED.
 - WHEN USING MATTING WITH SEED, DO NOT SEED THE AREA. FOLLOW MANUFACTURER'S RECOMMENDATIONS.
 - BEGIN AT THE TOP OF THE SLOPE BY ANCHORING THE RECPs IN A 6\"/>
 - ROLL THE RECPs (A) DOWN OR (B) HORIZONTALLY STEP BY STEP ACROSS THE SLOPE TAMPERING IT DOWN ALONG THE WAY. RECPs SHALL UNROLL WITH APPROPRIATE SIDE TIGHTLY AGAINST THE SOIL SURFACE. RECPs MUST BE SECURELY FASTENED TO SOIL SURFACE BY PLACING STAPLES/STAKES IN APPROPRIATE LOCATIONS AS SHOWN IN THE STAPLE PATTERN GUIDE. WHEN USING THE DOT SYSTEM, STAPLES/STAKES SHOULD BE PLACED THROUGH EACH OF THE COLORED DOTS CORRESPONDING TO THE APPROPRIATE STAPLE PATTERN.
 - THE EDGES OF PARALLEL RECPs MUST BE STAKED WITH APPROXIMATELY 2\"/>
 - CONSECUTIVE RECPs SPICED DOWN THE SLOPE MUST BE PLACED END OVER END (SHINGLE STYLE) WITH AN APPROXIMATE 3\"/>
 - IN LOOSE SOIL CONDITIONS, THE USE OF STAPLE OR STAKE LENGTHS GREATER THAN 6\"/>

NOT TO SCALE

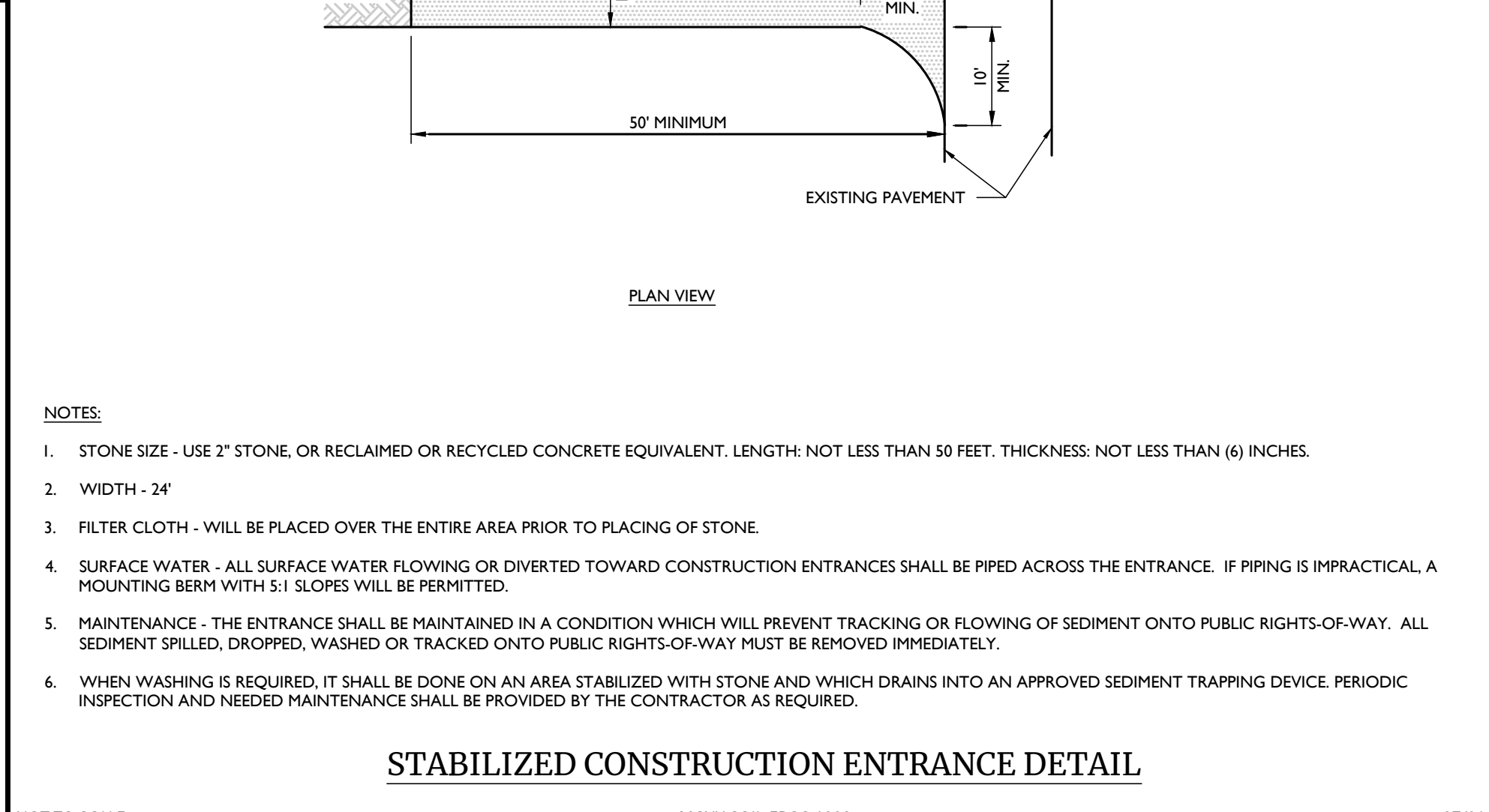

- NOTES:
- GEOTEXTILE TO BE FASTENED SECURELY TO FENCE POST BY USING WIRE TIES OR HOG RINGS. USE 3 FASTENERS PER POST.
 - SPlicing OF INDIVIDUAL ROLLS SHALL NOT OCCUR AT LOW POINTS.
 - ALL SILT FENCE TO BE INSPECTED AND REMEDIAL MAINTENANCE PERFORMED BY THE CONTRACTOR AS REQUIRED. MATERIAL REMOVED WHEN 'BULGES' DEVELOP IN THE SILT FENCE.
 - WHEN TWO SECTIONS OF FILTER FABRIC ARE JOINED, THEY SHALL BE OVER-WRAPPED BY SIX INCHES AND FOLDED.
 - FILTER FABRIC TO BE EITHER FILTER X, MIRAFI 100X, STABILURKA THORN, OR APPROVED EQUIVALENT.
 - PREFABRICATED UNITS SHALL MEET THE MINIMUM REQUIREMENTS SHOWN.
 - IF SPACE PERMITTED, LOCATE SILT FENCE 10' AWAY FROM TOE OF SLOPE IF THE SLOPE IS STEEPER THAN 1:1.

NOT TO SCALE

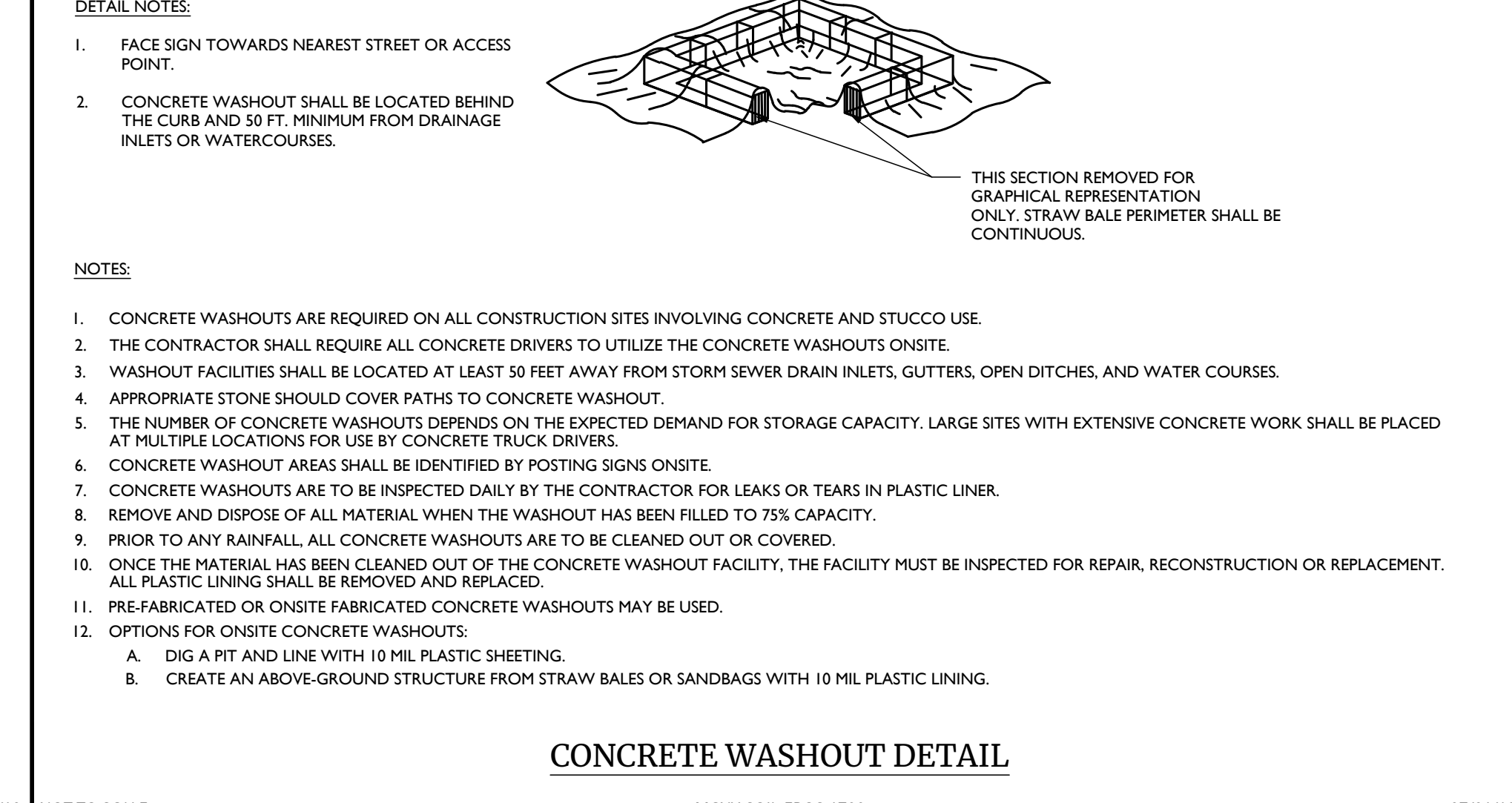

- DETAIL NOTES:
- FACE SIGN TOWARDS NEAREST STREET OR ACCESS POINT.
 - CONCRETE WASHOUT SHALL BE LOCATED BEHIND THE CURB AND 50 FT. MINIMUM FROM DRAINAGE INLETS OR WATERCOURSES.
- NOTES:
- CONCRETE WASHOUTS ARE REQUIRED ON ALL CONSTRUCTION SITES INVOLVING CONCRETE AND STUCCO USE.
 - THE CONTRACTOR SHALL REQUIRE ALL CONCRETE DRIVERS TO UTILIZE THE CONCRETE WASHOUTS ON SITE.
 - WASHOUT FACILITIES SHALL BE LOCATED AT LEAST 50 FEET AWAY FROM STORM SEWER DRAIN INLETS, GUTTERS, OPEN DITCHES, AND WATER COURSES.
 - APPROPRIATE STONE SHOULD COVER PATHS TO CONCRETE WASHOUT.
 - THE NUMBER OF CONCRETE WASHOUTS DEPENDS ON THE EXPECTED DEMAND FOR STORAGE CAPACITY. LARGE SITES WITH EXTENSIVE CONCRETE WORK SHALL BE PLACED AT MULTIPLE LOCATIONS FOR USE BY CONCRETE TRUCK DRIVERS.
 - CONCRETE WASHOUT AREAS SHALL BE IDENTIFIED BY POSTING SIGNS ON SITE.
 - CONCRETE WASHOUTS ARE TO BE INSPECTED DAILY BY THE CONTRACTOR FOR LEAKS OR TEARS IN PLASTIC LINER.
 - REMOVE AND DISPOSE OF ALL MATERIAL WHEN THE WASHOUT HAS BEEN FILLED TO 75% CAPACITY.
 - PRIOR TO ANY RAINFALL, ALL CONCRETE WASHOUTS ARE TO BE CLEANED OUT OR COVERED.
 - ONCE THE MATERIAL HAS BEEN CLEANED OUT OF THE CONCRETE WASHOUT FACILITY, THE FACILITY MUST BE INSPECTED FOR REPAIR, RECONSTRUCTION OR REPLACEMENT. ALL PLASTIC LINING SHALL BE REMOVED AND REPLACED.
 - PREFABRICATED OR ON SITE FABRICATED CONCRETE WASHOUTS MAY BE USED.
 - OPTIONS FOR ON SITE CONCRETE WASHOUTS:
 - DIG A PIT AND LINE WITH 10 MIL PLASTIC SHEETING.
 - CREATE AN ABOVE-GROUND STRUCTURE FROM STRAW BALES OR SANDBAGS WITH 10 MIL PLASTIC LINING.

NOT TO SCALE

UNAUTHORIZED ALTERATION OR ADDITION TO A SURVEY OR ENGINEERING MAP BEARING A LICENSED LAND SURVEYOR OR PROFESSIONAL ENGINEER IS A VIOLATION OF SECTION 7209, SUB-DIVISION 2, OF THE NEW YORK STATE EDUCATION LAW. ONLY MAPS WITH THE LAND SURVEYOR OR PROFESSIONAL ENGINEER'S SEAL ARE GENUINE TRUE AND CORRECT COPIES OF THE LAND SURVEYOR OR PROFESSIONAL ENGINEER'S ORIGINAL WORK AND OPINION.

Colliers
Engineering & Design
www.colliersengineering.com

Doing Business as **MASER**
PROTECT YOURSELF
811 before you dig.
FOR STATE SPECIFIC DIRECT PHONE NUMBERS VISIT: WWW.CALL811.COM

REV.	DATE	DRAWN BY	DESCRIPTION
1	02/04/22	CDR	REVISED WETLAND IMPACT PREDICTION AND DETAILS FOR GCS SUBMISSION.
2	01/13/23	CDR	REVISED PER STORMWATER TESTING & PLANNING BOARD COMMENTS.
3	06/15/24	TPS	REVISED PER REMOVAL OF SUBSURFACE STORMWATER TREATMENT.
4	07/23/24	TPS	REVISED PER PLANNING BOARD COMMENTS.
5	01/29/25	TPS	REVISED PER PLANNING BOARD & PUBLIC COMMENTS.

Cory Daniel Robinson
NEW YORK LICENSED PROFESSIONAL ENGINEER
LICENSE NUMBER: 103788
COLLIERS ENGINEERING & DESIGN CT, P.C.
N.Y. C.O.A.#: 0017609

PRELIMINARY SITE PLAN
FOR
DEWPOINT NORTH LLC
SECTION 4, BLOCK 1, LOT 50.2
TOWN OF WAWAYANDA
ORANGE COUNTY
NEW YORK STATE

Colliers Engineering & Design
555 Hudson Valley Avenue Suite 101
New Windsor, NY 12553
Phone: 845.564.4495
SCALE: AS SHOWN DATE: 01/10/2022 DRAWN BY: MAS CHECKED BY: CDR
PROJECT NUMBER: 20006912A DRAWING NAME: C-SEC-NRTH
SHEET TITLE: SOIL EROSION & SEDIMENT CONTROL DETAILS
SHEET NUMBER: C-601

NOTE: DO NOT SCALE DRAWINGS FOR CONSTRUCTION.